

**AIREGARD™ ES Energy Saver Vertical Laminar Flow
Clean Workstation
Model NU-140E
Bench Top Model**

Operation and Maintenance Manual

**July, 2020
Revision 5
Series A**



Manufactured By:
NuAire, Inc.
2100 Fernbrook Lane
Plymouth, MN 55447
Toll-Free: 1-800-328-3352
In Minnesota: (763)-553-1270
Fax: (763)-553-0459

**AIREGARD™ ES Energy Saver Vertical Laminar Flow
Clean Workstation
Model NU-140E
Bench Top Model
Operation and Maintenance Manual**

Table of Contents

Section No. 1	General Description
Section No. 2	Models & Features
Section No. 3	Shipments
Section No. 4	Installation Instructions
4.1	Location
4.2	Set-up Instructions
4.3	Certification Testing Methods and Equipment
Section No. 5	Operating the Laminar Flow Clean Workstation
5.1	Operator Controls & Indicators
5.2	Operating Guidelines
5.3	Ergonomics
5.4	Cleaning Procedures
Section No. 6	General Maintenance
6.1	Fluorescent Lamp Bulb Replacement
6.2	HEPA Filter Replacement
6.3	Pre-filter Replacement
Section No. 7	Error Indicators and Troubleshooting
Section No. 8	Polycarbonate Material Compatibility
Section No. 9	Remote Contacts
Section No. 10	Optional Equipment
10.1	Ultraviolet Lamp
10.2	Electrical/Environmental Requirements
Section No. 11	Electrical/Environmental Requirements
Section No. 12	Disposal and Recycle
Insert	Replacement Parts List, Warranty

Manual Drawings

BCD-19868.....	Specification Drawing NU-140-330
BCD-19847.....	Specification Drawing NU-140-430
BCD-19869.....	Specification Drawing NU-140-530
BCD-19665.....	Specification Drawing NU-140-630

Assembly Drawings

ACD-06899.....	Blower Brace Removal
BCD-19015.....	Base Stand Telescoping with Leg Levelers
BCD-19016.....	Base Stand Telescoping with Caster
CD-000018.....	Hydraulic Base Stand with Castors
CD-000019.....	Hydraulic Base Stand with Leg Levelers
BCD-16521.....	AEROMAX™ Front Panel
BCD-19998.....	HEPA Filter Replacement
BCD-20293.....	Outlet Option Installation

Electrical Schematics

BCD-19859.....	Electrical Schematic 230V
----------------	---------------------------

**AIREGARD™ ES Energy Saver Vertical Laminar Flow
Clean Workstation
Model NU-140E
Manufactured By:
NuAire, Inc.,
Plymouth, Minnesota**

1.0 General Description

NuAire AIREGARD™ Vertical Laminar Flow Clean Workstations utilize the newest technologies in laminar airflow design, materials and manufacturing processes. The clean workstation can be used where clean airflow per ISO 14644-1 is required for the preparation of injectable drugs, IV solutions, tissue culture, optics, microelectronics, etc. The clean bench **should not** be used for any work that involves biological agents assigned a level of Risk 1 through 4 as classified by the Centers for Disease Control (CDC), Atlanta, Georgia, since the Vertical flow offers no personnel protection against these agents. The clean bench should only be used to protect the product from contamination. The clean bench is optionally available with a base stand, placing the work surface at 30" (762mm) or 36" (914mm). A significant number of design innovations give the NuAire Laminar flow equipment superior performance qualities in airflow, lighting, noise levels and vibration.

1.1 Safety Instructions

These safety instructions describe the safety features of the AIREGARD™ Vertical Laminar Flow Clean Workstation model NU-140E. The workstation has been manufactured using the latest technological developments and has been thoroughly tested before delivery. It may, however, present potential hazards if it is not used according to the intended purpose or outside of operating parameters. Therefore, the following procedures must always be observed:

- The workstation must be operated only by trained and authorized personnel.
- For any operation of this unit, the operator must prepare clear and concise written instructions for operating and cleaning, utilizing applicable safety data sheets, plant hygiene guidelines, and technical regulations, in particular.
 - which decontamination measures are to be applied for the workstation and accessories,
 - which measures are to be taken in the case of an accident.
- Repairs to the device must be carried out only by trained and authorized expert personnel.
- Keep these operating instructions close to the unit so that safety instructions and important information are always accessible.
- Should you encounter problems that are not detailed adequately in the operating instructions, please contact your NuAire Representative of NuAire technical Services.

1.2 Explanation of Symbols



Safety alert symbol indicates a potentially hazardous situation which, if not avoided, could result in death of serious injury.

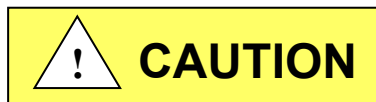

Safety alert symbol indicates a potentially hazardous situation which, if not avoided, may result in minor or moderate injury.

CAUTION: CAUTION used without the safety alert symbol indicates a potentially hazardous situation which, if not avoided, may result in property damage.



Potential electrical hazard, only qualified person to access.

 **NOTE:** Used for important information.



Biohazard



Flammable Hazard



Hazardous Gases! Personal Protection Equipment Required.



Ground, Earth



Lead Free



Chemical Hazard

2.0 Models and Features

NuAire's Model Number NU-140E designates the basic design series of AIREGARD™ Vertical Laminar Flow Clean Workstation with the blower/motor located above the work surface (i.e. bench series). Model numbers are shown below.

Model Number

NU-140-330E

NU-140-430E

NU-140-530E

NU-140-630E

REV	ECO	DESCRIPTION	DATE	DFTM	CHKD
D	000035	UPDATED DRAWING	05/31/2019	LS	BK

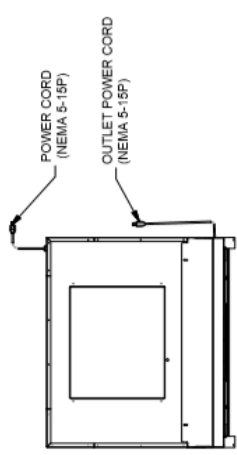

NU-140-300 BASESTAND DIMENSION OPTIONS				
BASESTAND MODEL	BASESTAND TYPE	DIM "A"	DIM "B"	
NU-200-133	TELESCOPING LEG LEVELERS	84 1/2(2146) TO 82 1/2(2350)	28 1/2(713) TO 34 1/2(876)	
NU-200-137	TELESCOPING CASTERS	84 3/4(2153) TO 82 3/4(2356)	28 3/4(740) TO 34 3/4(883)	
NU-200-147 (115V) / NU-200-148 (230V)	AUTOLIFT LEG LEVELERS	88 1/4(2219) TO 87 1/4(2247)	28 1/4(718) TO 36 1/4(927)	
NU-200-148 (115V) / NU-200-150 (230V)	AUTOLIFT CASTERS	85 7/8(2182) TO 86 7/8(2240)	27 7/8(708) TO 35 7/8(907)	

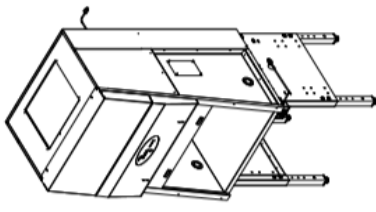
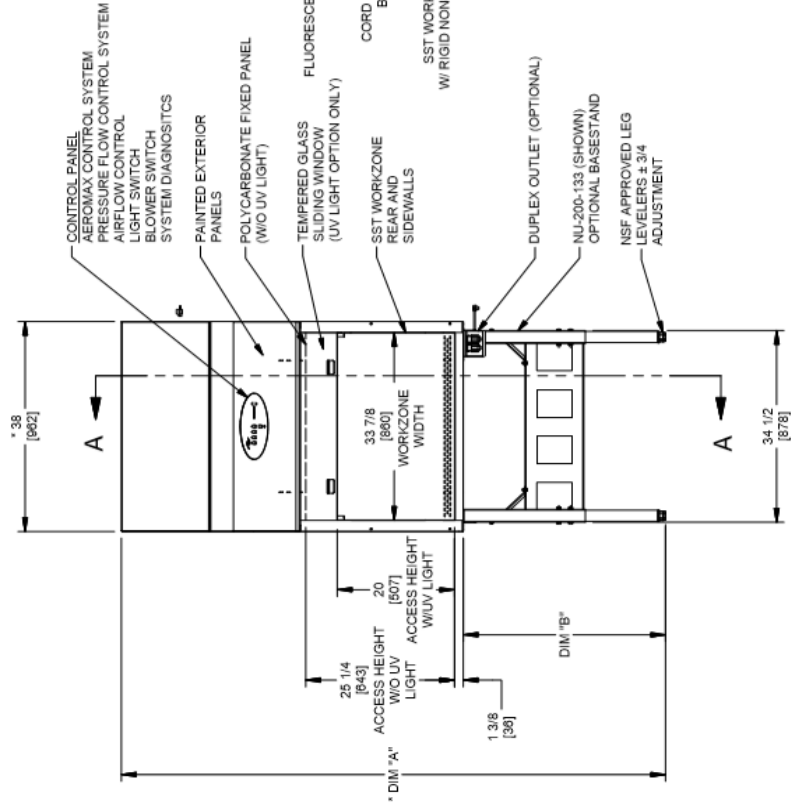
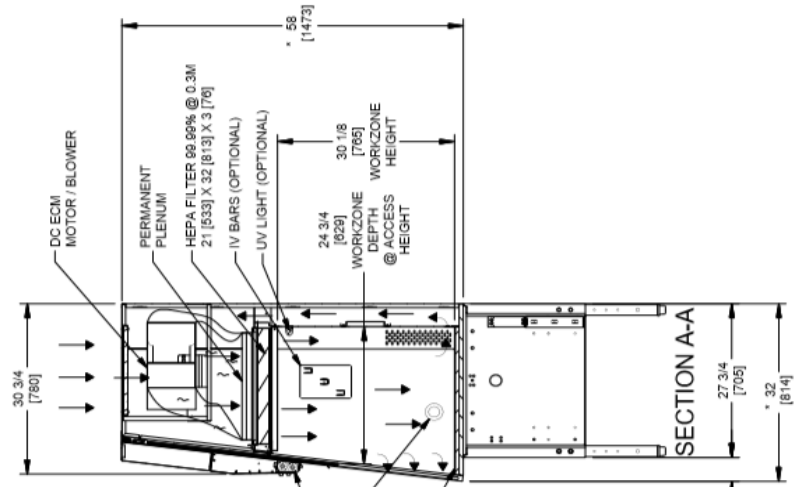

* OVERALL DIMENSIONAL TOLERANCE ± 1/4" [6.35]
ALL OTHER DIMENSIONS ± 1/8" [3.17]

TITLE		NU-140-300 Specification Drawing	
DFTM	DATE	CHKD	SHEET
LS	5/1/2018	BP	1 OF 1
DRAWING NUMBER		BCD-19868	
INCH		MILLIMETER	
		D	

REV	ECO	DESCRIPTION	DATE	DFTM	CHKD
D	000035	UPDATED DRAWING	05/31/2019	LS	BK

NU-140-400 BASESTAND DIMENSION OPTIONS					
BASESTAND MODEL	BASESTAND TYPE	DIM "A"	DIM "B"		
NU-200-134	TELESCOPING, LEG LEVELERS	84 1/2 [2146]	TO 82 1/2 [2060]	26 1/2 [673]	TO 34 1/2 [876]
NU-200-138	TELESCOPING, CASTERS	84 3/4 [2153]	TO 82 3/4 [2066]	26 3/4 [680]	TO 34 3/4 [883]
NU-200-151 (115V) / NU-200-152 (230V)	AUTOLIFT, LEG LEVELERS	86 1/2 [2181]	TO 87 1/2 [2247]	28 1/4 [718]	TO 36 1/4 [917]
NU-200-153 (115V) / NU-200-154 (230V)	AUTOLIFT, CASTERS	85 7/8 [2182]	TO 86 7/8 [2246]	27 7/8 [708]	TO 38 7/8 [987]

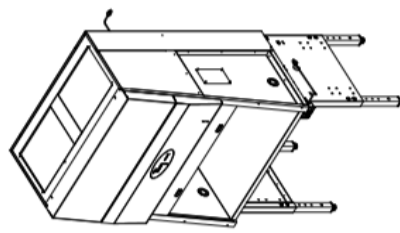
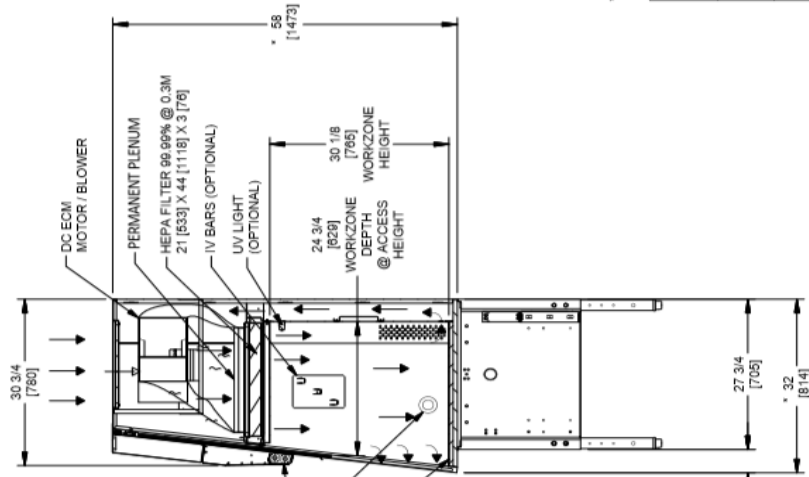
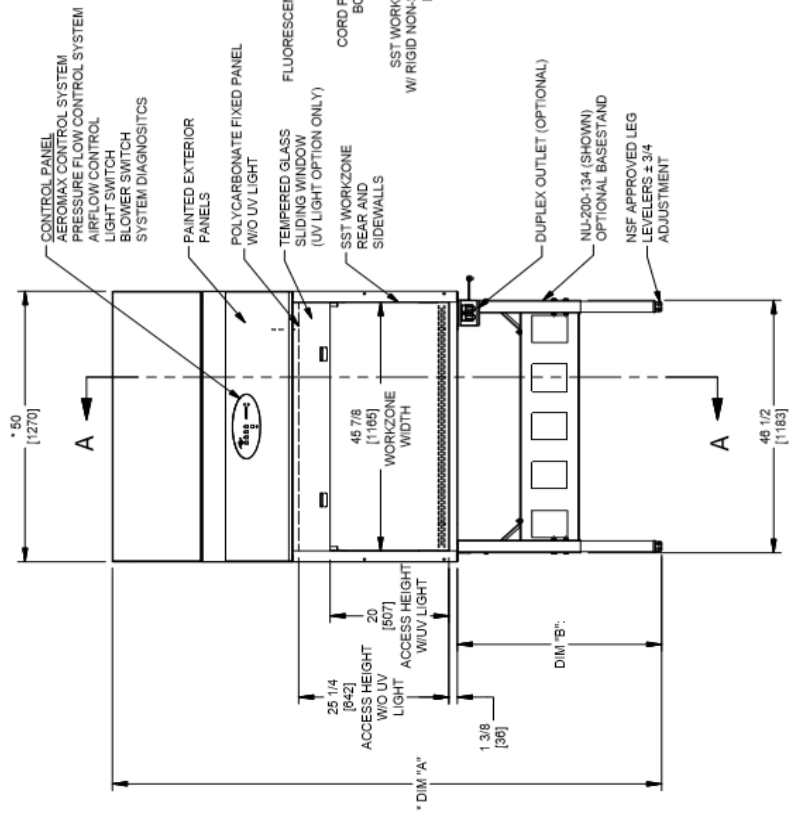
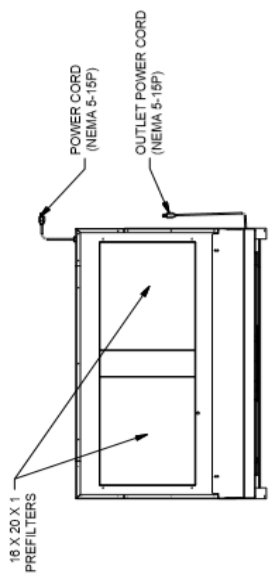

* OVERALL DIMENSIONAL TOLERANCE ± 1/4" [6.35]
ALL OTHER DIMENSIONS ± 1/8" [3.17]



TITLE		NU-140-400 Specification Drawing	
DFTM	DATE	CHKD	SHEET
LS	4/18/2018	BP	1 OF 1
DRAWING NUMBER		BCD-19847	
INCH MILLIMETER		SECTION A-A	
		D	

REV	ECO	DESCRIPTION	DATE	DFTM	CHKD
D	000035	UPDATED DRAWING	02/28/2019	LS	BK

BASESTAND MODEL	DIM "A"	DIM "B"
NU-140-500 BASESTAND DIMENSION OPTIONS		
BASESTAND TYPE		
TELESCOPING, LEG LEVELERS	84 1/2 [2140] TO 82 1/2 [2350]	26 1/2 [673] TO 34 1/2 [876]
TELESCOPING, CASTERS	84 3/4 [2163] TO 82 3/4 [2356]	26 3/4 [680] TO 34 3/4 [883]
AUTOLIFT, LEG LEVELERS	86 1/4 [2191] TO 87 1/4 [2471]	28 1/4 [718] TO 36 1/4 [921]
AUTOLIFT, CASTERS	85 7/8 [2182] TO 86 7/8 [2461]	27 7/8 [708] TO 38 7/8 [987]

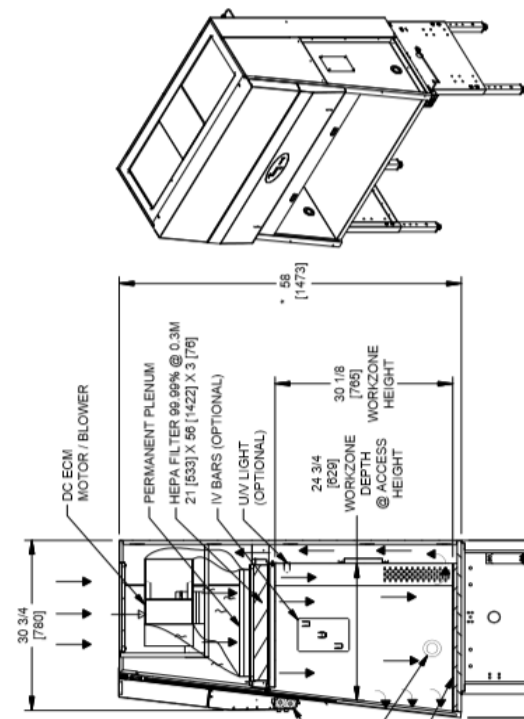
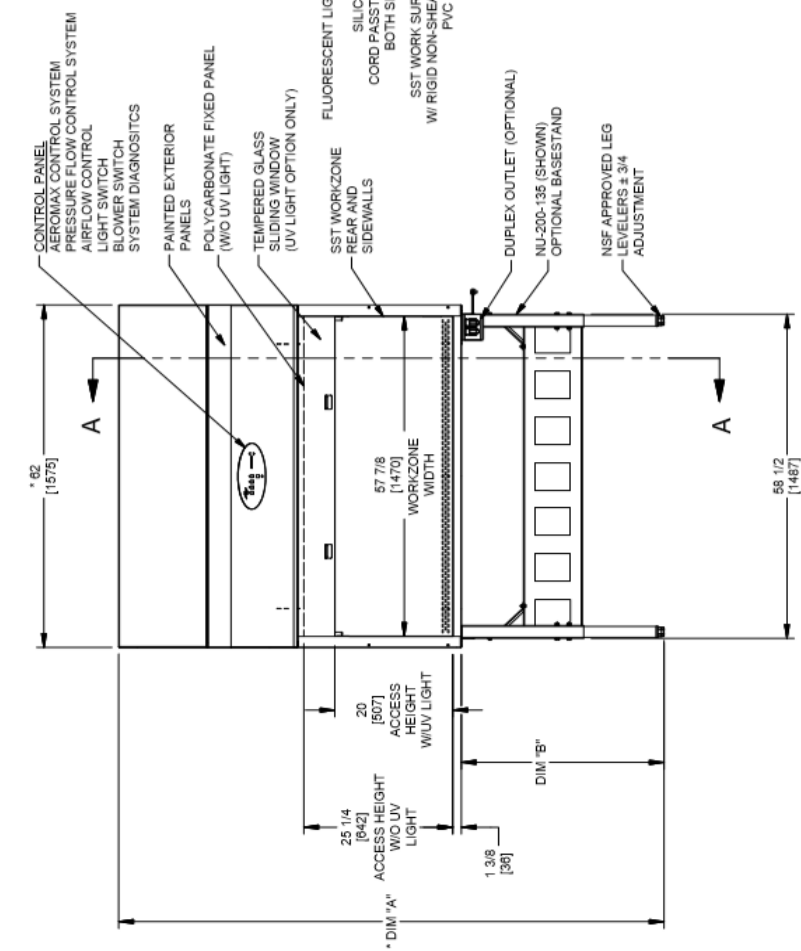
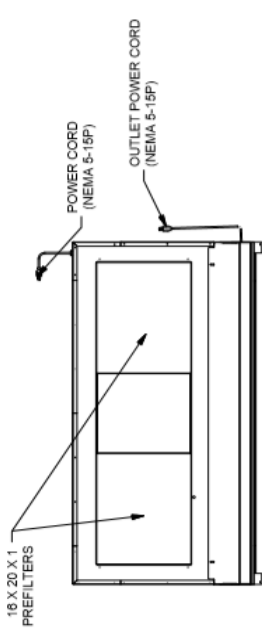

* OVERALL DIMENSIONAL TOLERANCE ± 1/4" [6.35]
ALL OTHER DIMENSIONS ± 1/8" [3.17]

TITLE			
NU-140-500 Specification Drawing			
DFTM	DATE	CHKD	SHEET
LS	5/1/2018	BP	1 OF 1
DRAWING NUMBER			D
INCH MILLIMETER			BCD-19869

REV	ECO	DESCRIPTION	DATE	DFTM	CHKD
D	000035	UPDATED DRAWING	05/30/2019	LS	BK

BASESTAND MODEL		BASESTAND TYPE		DIM "A"		DIM "B"	
NU-200-138	TELESCOPING, LEG LEVELERS	84 1/2 [2148]	TO 92 1/2 [2350]	28 1/2 [723]	TO 34 1/2 [876]		
NU-200-140	TELESCOPING, CASTERS	84 3/4 [2163]	TO 92 3/4 [2366]	29 3/4 [750]	TO 34 3/4 [883]		
NU-200-152 (115V) / NU-200-160 (230V)	AUTOLIFT, LEG LEVELERS	88 1/4 [2181]	TO 97 1/4 [2471]	28 1/4 [718]	TO 38 1/4 [967]		
NU-200-161 (115V) / NU-200-162 (230V)	AUTOLIFT, CASTERS	88 7/8 [2262]	TO 98 7/8 [2461]	27 7/8 [708]	TO 38 7/8 [987]		

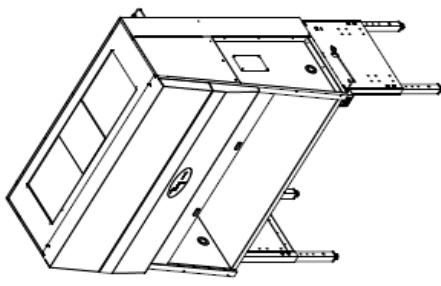
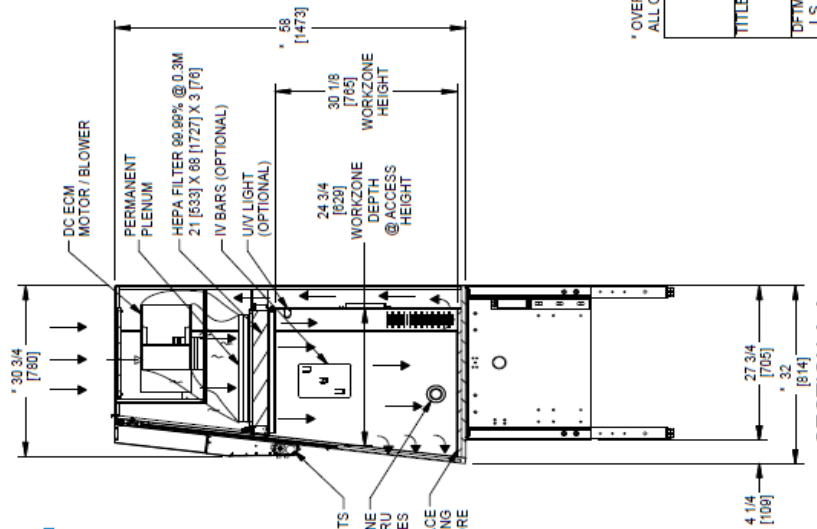
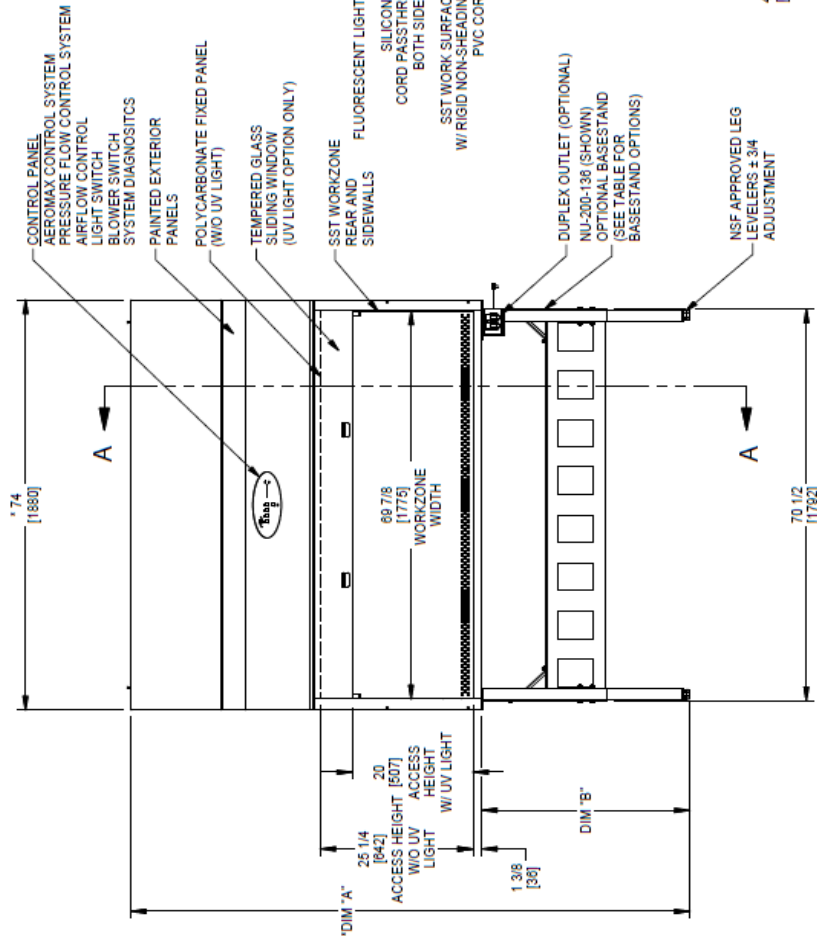
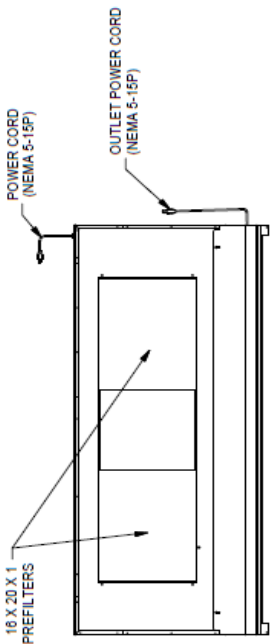

* OVERALL DIMENSIONAL TOLERANCE ± 1/4" [3.18]
ALL OTHER DIMENSIONS ± 1/8" [3.17]



TITLE
NU-140-600 Specification Drawing

DFTM	DATE	CHKD	SHEET	OF
LS	3/23/2018		1	1

SECTION A-A

DRAWING NUMBER
BCD-19665

D

3.0 Shipments

NuAire takes every reasonable precaution to insure that your AIREGARD™ Clean Workstation arrives without damage. Motor carriers are carefully selected and shipping cartons have been specially designed to insure your purchase. However, damage can occur in any shipment and the following outlines the steps you should take on receipt of a NuAire AIREGARD™ Clean Workstation to be sure that if damage has occurred, the proper claims and actions are taken immediately.

3.1 Damaged Shipments

- 3.1.1** Terms are factory, unless stated otherwise. Therefore, it is important to check each shipment before acceptance.
- 3.1.2** If there is visible damage, the material can be accepted after the driver makes a notation on the consignee's copy of the freight bill. Then an inspection must be made to verify the claim against the carrier. This inspection is the basis of your filing the claim against the carrier.
- 3.1.3** If concealed damage is found, it is absolutely necessary to NOTIFY THE FREIGHT AGENT AT ONCE and request an inspection. Without this inspection, the transportation company may not accept a claim for loss or damage. If the carrier will not perform the inspection, an affidavit must be prepared stating that he was contacted on a certain date and that he failed to comply with the request. This, along with other papers in the customer's possession will support the claim.

4.0 Installation Instructions

4.1 Location

Within the laboratory, pharmacy, production area, etc., the ideal location for the clean workstation is away from personnel traffic lanes, air vents (in or out), doors and/or other source of disruptive air currents. If drafts or other disruptive air currents exceed the face velocity of the HEPA filter, the potential exists for contaminated air to enter the work area of the workstation. Please note, however, that the work area has been constructed to minimize the effect of air currents by providing sidewalls that are an extension of the HEPA filter flow area.

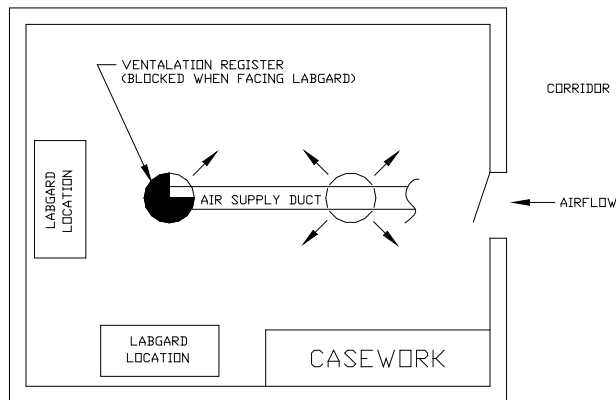

Where space permits, a clean six (6) inch (152mm) area should be permitted on each side of the workstation for maintenance purposes. The electrical outlet into which the workstation is connected should be readily accessible.

The workstation shall be positioned as not to obstruct the power supply outlet or the circuit breaker distribution panel.

4.2 Set-Up Instructions

Remove outer shipping protection (carton or crating). If the workstation is fastened to a base skid, it is usually the best procedure to leave the skid in place until the workstation is located in its approximate position to facilitate ease in handling. It can then be removed from the skid by removing the four bolts holding the workstation to the skid.

4.2.1 Motor Shipping Bracket

The motor is securely fastened to the workstation during shipment to prevent damage to the blower housing mounting brackets. The procedure for removing the motor shipping bracket is shown in Drawing ACD-06899.

4.2.2 Base Stand Assembly

The base stand is shipped K.D. in a separate carton and is assembled per the Drawing accompanied with the unit. With a forklift or other suitable lifting device, lift the NU-140E between the top of the skid and the bottom of the workstation, slightly off of the floor and remove the four bolts holding the skid to the workstation (one in each corner). Now lift the workstation on top of the base and bolt the base stand to the workstation using four 4/20 x 3/4" (18mm) bolts and washers provided. Place the workstation in its desired location.

4.2.3 Gas Service

NuAire doesn't recommend the use of natural gas within the clean bench, but if gas service is determined to be necessary for the application by the appropriate safety personnel, appropriate safety measures must take place.

Once the determination has been made by the appropriate safety personnel, the application of natural gas must be performed in accordance to national, state and local codes.



IT IS ALSO STRONGLY RECOMMENDED THAT AN EMERGENCY GAS SHUTOFF VALVE BE PLACED JUST OUTSIDE THE CLEAN BENCH ON THE GAS SUPPLY LINE.

All NuAire clean benches meet the safety requirements of UL and CSA for Laboratory Equipment. To comply with these safety requirements, NuAire uses only certified gas valves. In addition, if external piping is required, only black pipe is used for this application.

As previously stated NuAire doesn't recommend the use of natural gas within the clean bench and **ASSUMES NO RESPONSIBILITY FOR ITS USE. USE AT YOUR OWN RISK.** The Bunsen burner flame within the clean bench disrupts the laminar air stream, which must be maintained for maximum efficiency.



IF THE PROCEDURE DEMANDS USE OF A FLAME, A BUNSEN BURNER WITH ON DEMAND IGNITION IS STRONGLY RECOMMENDED. DO NOT USE CONSTANT FLAME GAS BURNERS.

During use, the Bunsen burner should be placed to the rear of the workspace where resulting air turbulence will have a minimal effect.

4.2.4 Plumbing Services

Ground key cocks with the type of service specified by the snap-in button on the handle, are located in the work zone. The ground key cocks are not recommended for pressures over 30 p.s.i. Reducing valves should be installed external to the workstation if necessary. Ground key cocks should never be used for oxygen service. A special needle valve for oxygen service is required and available upon request.

External connection is to 3/8 inch (10mm) FPT coupling through the sidewalls. Connection to plant utilities should be made with proper materials for the individual service and according to national and/or local codes. Observe all labels pertaining to the type of service and operating pressure.

REV	CO	DESCRIPTION	DATE	DFTR	CHKD
B	000035	UPDATED NOTES AND TITLEBLOCK	05/30/2019	LS	BK

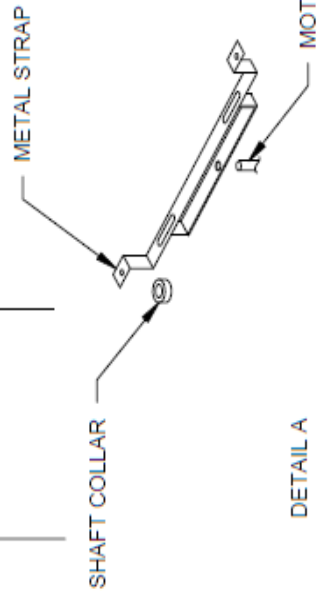
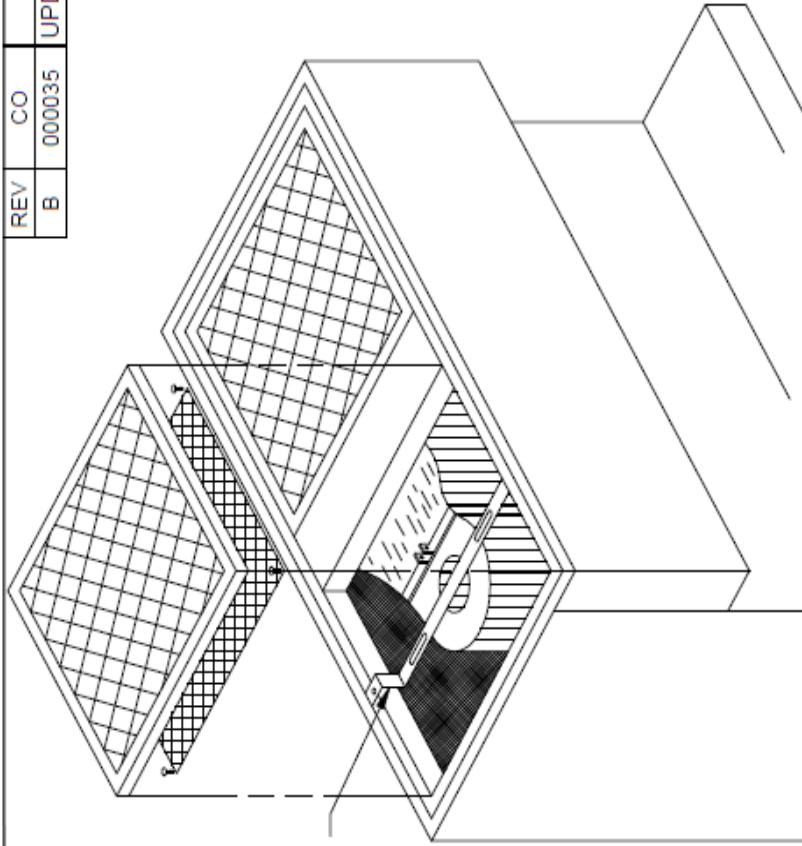

DETAIL A

- STEPS:
1. REMOVE PRE-FILTER ON TOP OF UNIT ON BLOWER SIDE.
 2. REMOVE THE PRE-FILTER SCREEN SCREWS AND THE PRE-FILTER SCREEN.
 3. REMOVE THE THE 4 SCREWS ON THE METAL STRAP.
 4. LOOSEN THE SET SCREW ON THE SHAFT COLLAR.
 5. REMOVE THE STRAP AND COLLAR FROM THE UNIT.
 6. REPLACE THE PRE-FILTER SCREEN AND SCREW INTO PLACE.
 7. REPLACE THE PRE-FILTER.

NOTE: 1. THE METAL STRAP IS ONLY TO STABILIZE BLOWER SUSPENSION AND MOTOR AND MUST BE REMOVED FOR PROPER OPERATION.



TITLE

BLOWER BRACE REMOVAL

DFTR	PS	DATE	CHKD	AS	SHEET	1	OF	1
		11/15/1988						
DRAWING NUMBER			ACD-06899			B		

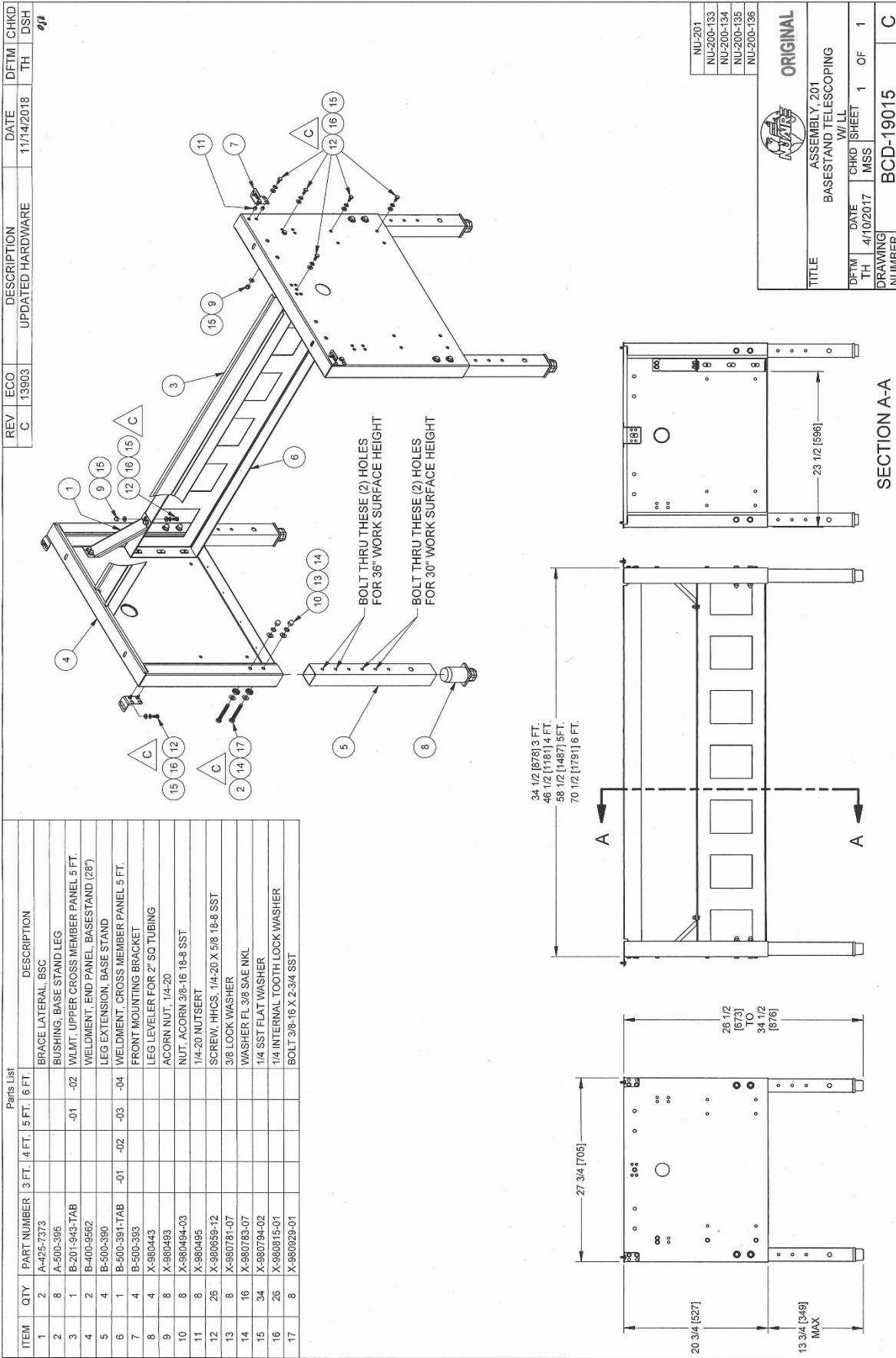

REV	ECO	DESCRIPTION	DATE	DFTM	CHKD
C	13903	UPDATED HARDWARE	11/14/2018	TH	DSH

REV	ECO	DESCRIPTION	DATE	DFTM	CHKD
C	13903	UPDATED HARDWARE	11/14/2018	TH	DSH

ITEM	QTY	PART NUMBER	3 FT.	4 FT.	5 FT.	6 FT.	DESCRIPTION
1	2	A-425-7373					BRACE LATERAL, BSC
2	8	A-500-395					BUSHING, BASE STAND LEG
3	1	B-201-943-TAB	-01				W/LMT. UPPER CROSS MEMBER PANEL 5 FT.
4	2	B-400-9562					WELDMENT, END PANEL, BASESTAND (28")
5	1	B-500-391-TAB	-01	-02	-03		WELDMENT, CROSS MEMBER PANEL 5 FT.
6	4	B-500-393					FRONT MOUNTING BRACKET
7	4	B-500-507					WELDMENT, LEG EXTENSION (CASTOR)
8	4	B-620-2285					BASESTAND, SAFETY ANGLE FOR 4 INCH CASTER
9	4	X-980040-08					CASTOR, SWIVEL, W/ BRACKET, 4", SST
10	16	X-980490-06					NUT, HEX 5/16 - 18, FINISHED, SST
11	8	X-980483					ACORN NUT, 1/4-20
12	8	X-980494-03					NUT, ACORN 3/8-16 18-8 SST
13	8	X-980495					1/4-20 NUTSERT
14	26	X-980659-12					SCREW, HHCS, 1/4-20 X 5/8 18-8 SST
15	16	X-980667-01					5/16-18 X 3/4 BOLT
16	8	X-980781-07					3/8 LOCK WASHER
17	16	X-980783-07					WASHER FL 3/8 SAE NKL
18	32	X-980790-06					WASHER FL 5/16 SAE SST
19	34	X-980794-02					1/4 SST FLAT WASHER
20	16	X-980795-05					WASHER LK 5/16" SPLIT 18-8 SST
21	26	X-980815-01					1/4 INTERNAL TOOTH LOCK WASHER
22	8	X-980929-01					BOLT 3/8-16 X 2-3/4 SST

Parts List

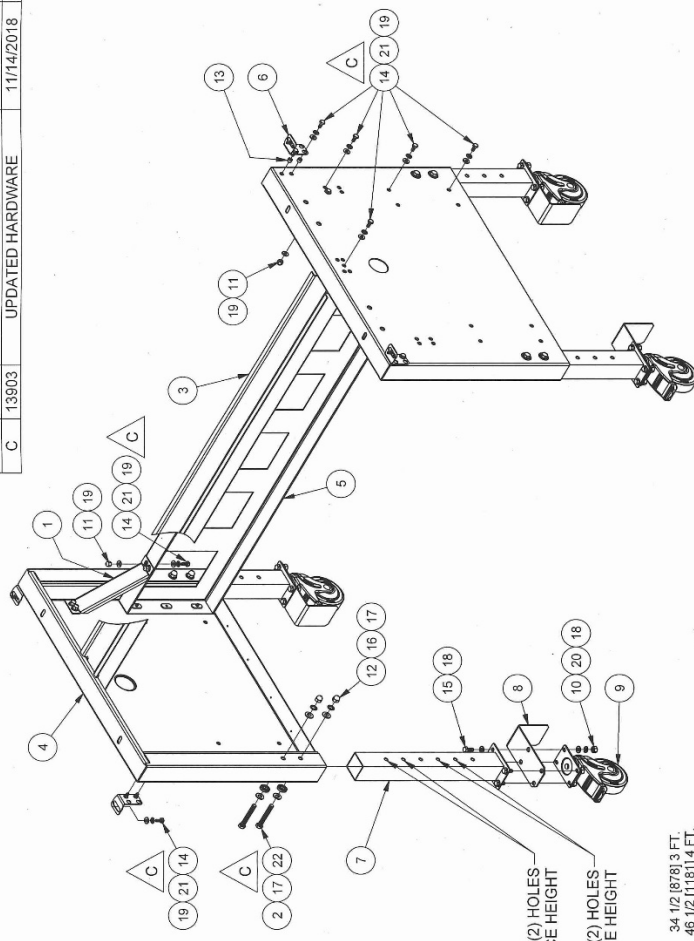

BOLT THRU THESE (2) HOLES
FOR 36" WORK SURFACE HEIGHT

BOLT THRU THESE (2) HOLES
FOR 30" WORK SURFACE HEIGHT

34 1/2 [878] 3 FT.
46 1/2 [1181] 4 FT.
58 1/2 [1487] 5 FT.
70 1/2 [1791] 6 FT.

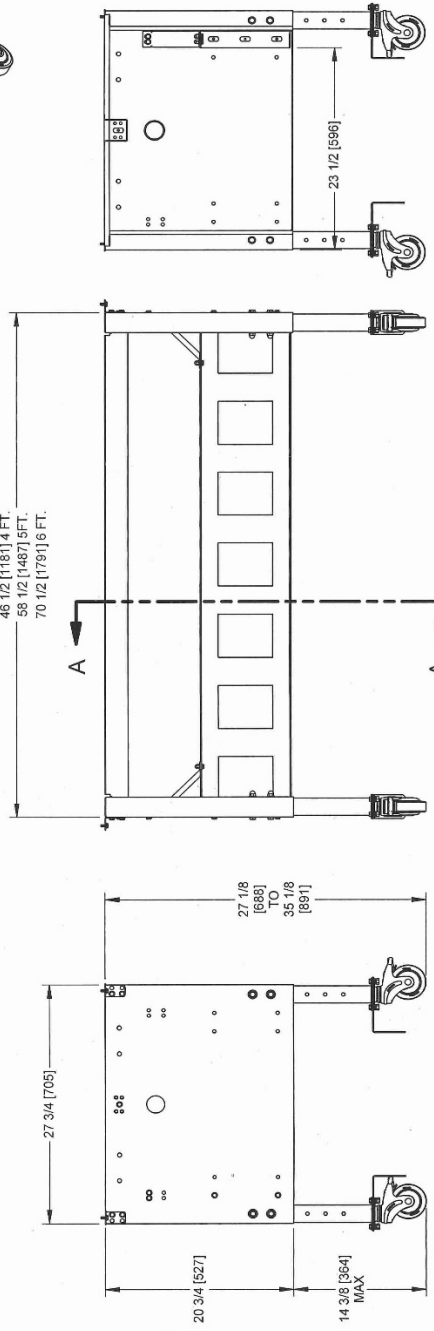

SECTION A-A

NU-201
NU-200-137
NU-200-138
NU-200-139
NU-200-140



TITLE		ASSEMBLY, 201 BASESTAND TELESCOPING W/ CASTER	
DFTM	DATE	CHKD	SHEET
TH	4/10/2017	MSS	1 OF 1
DRAWING NUMBER		BCD-19016	
		C	

REV	CO	DESCRIPTION	DATE	DFTM	CHKD
A	000132	RELEASED TO PRODUCTION	10/29/2019	TH	BK

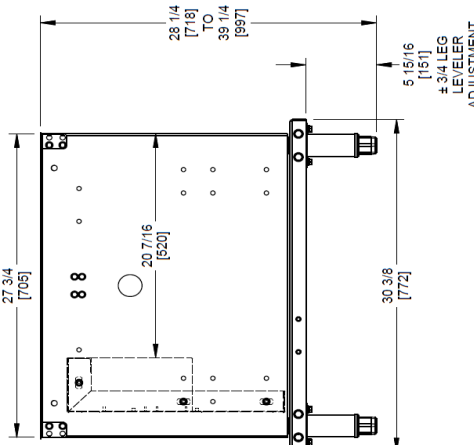
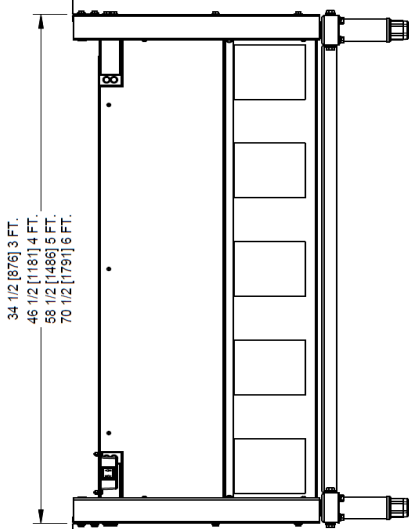
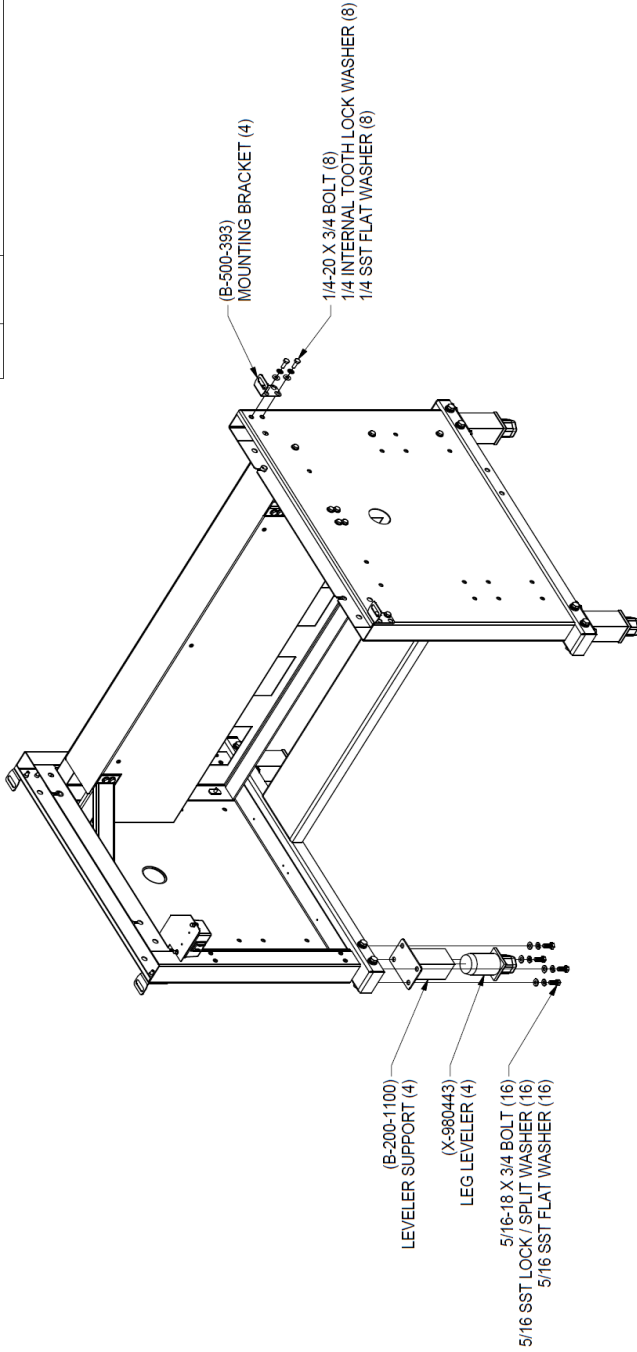

NU-200-147
NU-200-148
NU-200-151
NU-200-152
NU-200-155
NU-200-156
NU-200-159
NU-200-160



TITLE		140/240 HYDRAULIC BASE STAND ASSEMBLY W/LL	
DFTM	DATE	CHKD	SHEET
TH	10/29/2019	BK	1 OF 1
DRAWING NUMBER		CD-000018	
		A	

REV	CO	DESCRIPTION	DATE	DFTM	CHKD
A	000132	RELEASED TO PRODUCTION	10/29/2019	TH	BK

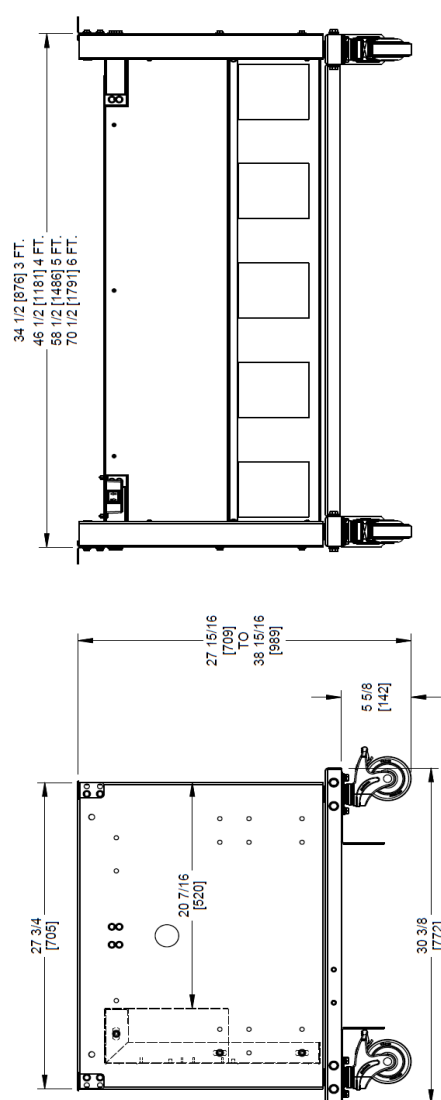
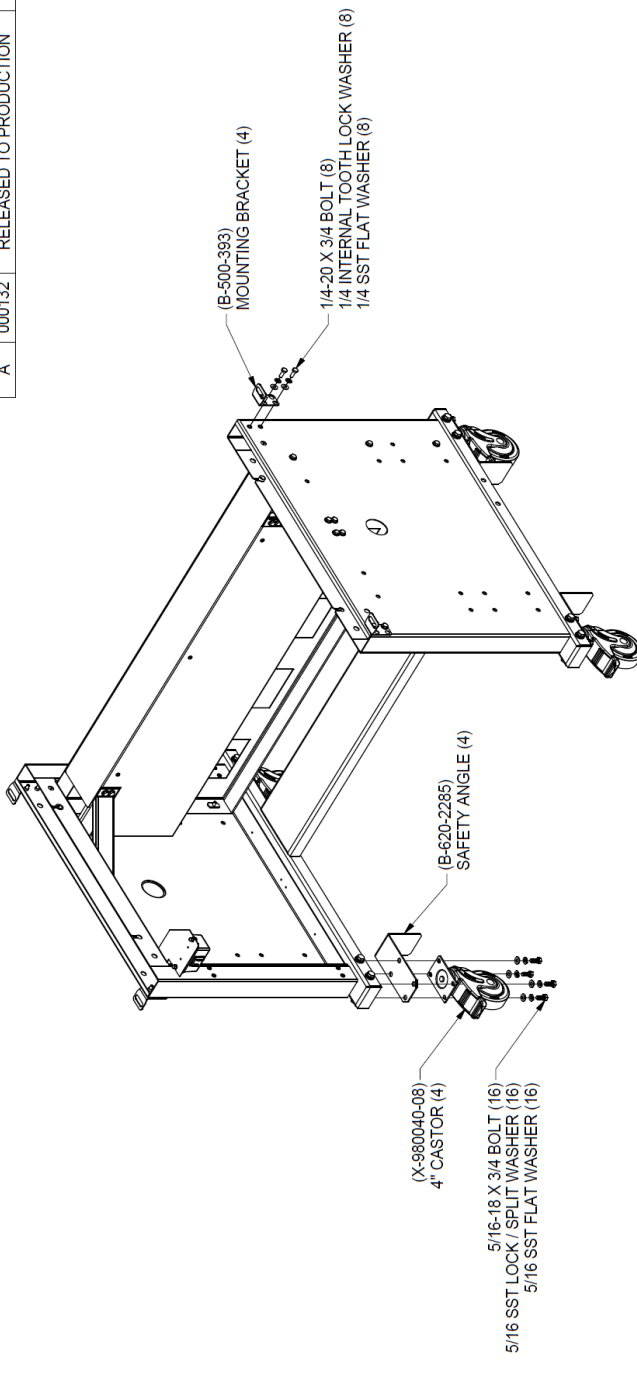

NU-200-149
NU-200-150
NU-200-153
NU-200-154
NU-200-157
NU-200-158
NU-200-161
NU-200-162

TITLE 140/240 HYDRAULIC BASE STAND ASSEMBLY W/ CASTORS						
DFTM	DATE	CHKD	SHEET	1	OF	1
TH	10/29/2019	BK				
DRAWING NUMBER		CD-000019				
		A				

4.2.5 Electrical Services

The Vertical Laminar Flow Clean Workstation may be "hardwired" (optional) or connected via an electrical power cord, which is standard. The unit requires 230 VAC, 50/60 Hz, single phase. (Current rating varies per workstation size, reference Electrical/Environmental Requirements).



It is recommended that power to each work station (power is defined by each work station's power cord), whether individual or joined work stations, be on its own branch circuit, protected with a circuit breaker at the distribution panel.

NOTE: THIS UNIT CONTAINS ELECTRONIC BALLASTS FOR THE FLUORESCENT LIGHTING. ELECTRONIC BALLASTS OPERATE WITH HIGH INRUSH CURRENT. IT IS NOT RECOMMENDED TO USE THIS PRODUCT WITH GROUND FAULT CIRCUIT INTERRUPTERS (GFCI'S) BECAUSE THE BALLASTS MAY CAUSE THE GFCI TO TRIP.

If a "hardwired" (conduit) connection is desired, an electrical junction box is provided on the top of the workstation with a removable cover. All wiring connections to the junction box should be done according to the National Electrical Code and/or local codes by a qualified electrician.

4.2.6 Final Assembly

The exterior surfaces and viewing glass are easily cleaned with any mild household detergent cleaner using a soft cloth. Harsh chemicals, solvent-type cleaners and abrasive cleaners should not be used. See section 5.4 for cleaning procedures. Turn the workstation on and let it operate for 5 minutes before using it as a clean bench.

4.3 Certification Testing Methods and Equipment

After installation and prior to use, NuAire recommends that the workstation be recertified to factory standards. At a minimum, the following tests should be performed.

1. HEPA filter media
2. Filter frame leak test
3. Airflow velocities

The testing methods and equipment required are specified on the factory inspection report included with this manual.

NOTE: IT IS RECOMMENDED THAT THESE TESTS BE PERFORMED BY A QUALIFIED TECHNICIAN WHO IS FAMILIAR WITH THE METHODS AND PROCEDURES FOR CERTIFYING CLEAN BENCHES.

NOTE: AFTER THE INITIAL CERTIFICATION, NUAIRE RECOMMENDS THAT THE WORKSTATION BE RECERTIFIED AT A MINIMUM ON AN ANNUAL BASIS AND AFTER EVERY FILTER CHANGE OR MAINTENANCE ACTION OR ANY TIME THE OPERATOR FEELS IT IS NECESSARY.

Note that the NuAire Clean Workstations, filters and seals provide premium performance; Quality control in both design and manufacturing insure superior reliability. However, protection to the product is so important, that certification to the performance requirements should be accomplished as stated to insure conformance to factory standards.

**AIREGARD™ ES Energy Saver Vertical Laminar Flow Work station
Models NU-140-330E/430E/530E/630E**

Catalog Number	Catalog Number			
	NU-140-330E Nominal 3 foot (0.9m)	NU-140-430E Nominal 4 foot (1.2m)	NU-140-530E Nominal 5 foot (1.5m)	NU-140-630E Nominal 6 foot (1.8m)
Performance Specifications 1. Product Protection	IEST-RP-CC002.4 ISO 14644-1	IEST-RP-CC002.4 ISO 14644-1	IEST-RP-CC002.4 ISO 14644-1	IEST-RP-CC002.4 ISO 14644-1
ISO 14644-1	ISO 5	ISO 5	ISO 5	ISO 5
Style of Work station	Bench top/console w/base stand/storage Work station	Bench top/console w/base stand/storage Work station	Bench top/console w/base stand/storage Work station	Bench top/console w/base stand/storage Work station
Work Station Construction	16/18 GA, powder coated steel exterior; 16/18 GA type 304 SST work zone	16/18 GA, powder coated steel exterior; 16/18 GA type 304 SST work zone	16/18 GA, powder coated steel exterior; 16/18 GA type 304 SST work zone	16/18 GA, powder coated steel exterior; 16/18 GA type 304 SST work zone
Diffuser for Air Supply (Metal)	Non-flammable	Non-flammable	Non-flammable	Non-flammable
HEPA Filter Seal Type: Supply Filter-99.99% Eff. on 0.3 microns	HEPEX Seal- Neoprene, Spring-loaded	HEPEX Seal- Neoprene, Spring-loaded	HEPEX Seal- Neoprene, Spring-loaded	HEPEX Seal- Neoprene, Spring-loaded
Optional Services, (Total) Position: Service Coupling (3/8 inch NPT) Gas Valve/Service Coupling (3/8inch NPT) Outlet	(3) Right/left sidewalls (3) Right/left sidewalls (1) Right/left area under worksurface	(3) Right/left sidewalls (3) Right/left sidewalls (1) Right/left area under worksurface	(3) Right/left sidewalls (3) Right/left sidewalls (1) Right/left area under worksurface	(3) Right/left sidewalls (3) Right/left sidewalls (1) Right/left area under worksurface
Work Station Size Inches (mm): Height Width Depth	58 (1473) 38 (965) 32 (813)	58 (1473) 50 (1270) 32 (813)	58 (1473) 62 (1575) 32 (813)	58 (1473) 74 (1880) 32 (813)
Work Zone Inches (mm): Height Width Depth (on work surface) Depth (at window access height)	30 1/8 (765) 33 7/8 (860) 26 3/4 (679) 24 7/8 (630)	30 1/8 (765) 45 7/8 (1165) 26 3/4 (679) 24 7/8 (630)	30 1/8 (765) 57 7/8 (1470) 26 3/4 (679) 24 7/8 (630)	30 1/8 (765) 69 7/8 (1775) 26 3/4 (679) 24 7/8 (630)
Airflow Volume at 90 fpm (.46 mps) CFM (CMH) #^	503 (855)	681 (1158)	859 (1460)	1037 (1763)
Heat Rejected, BTU, Per Hour	863	1256	1648	1962
Electrical: Volts, AC 50/60 Hz +Amps: Blower/Lights Rated Amps: 12 ft. Power Cord (one)	CE 230 1.1 5 14 GA - 3 Wire, 15A	CE 230 1.6 6 14 GA-3 Wire, 15A	CE 230 2.1 6 14 GA-3 Wire, 15A	CE 230 2.1 6 14 GA-3 Wire, 15A
Work Station Weights:*** Crated Shipping Weight Net Weight	340 lbs. /154 kg. 300 lbs. /136 kg.	405 lbs. /184 kg. 355 lbs. /161 kg.	470 lbs. /213 kg. 420 lbs. /191 kg.	565 lbs. /256 kg. 595 lbs. /270 kg.

10% of this value is recirculated

^ Measured at 6" below diffuser screen

*** Crated shipping weight does not include weight for accessories or options

+ Based on Work station with new filters running at 230VAC.

5.0 Operating the NU-140E

5.1 Aeromax™ Control System

5.1.1 Overview

The Aeromax™ control system is designed to service the control requirements of the AireGard™ ES NU-140E. The Aeromax™ control system consists of an electronic module that will perform the following functions:

- Easy user interface via LED's and function keys
- Control blower via solid state switch.
- Control lights via solid state switch.
- Disable audible alarm switch with ring back function.
- Control blower DC ECM motor/blower with solid-state DC Motor Controller that provides automatic compensation for line voltage variances.
- Monitor and display airflow system performance via PresurFlow™ monitor.

The AireGard™ ES NU-140E offers the latest digital microprocessor design technology for improved performance and safety. The Aeromax™ control system integrates a digital pressure sensor (PresurFlow™) to monitor the airflow performance. The Aeromax™ control system also integrates a DC ECM motor/blower controller that provides automatic compensation for both filter loading and line voltage variances. There is additional on/off control of blower and light. All the above functions are shown in a system block diagram (see figure 1).

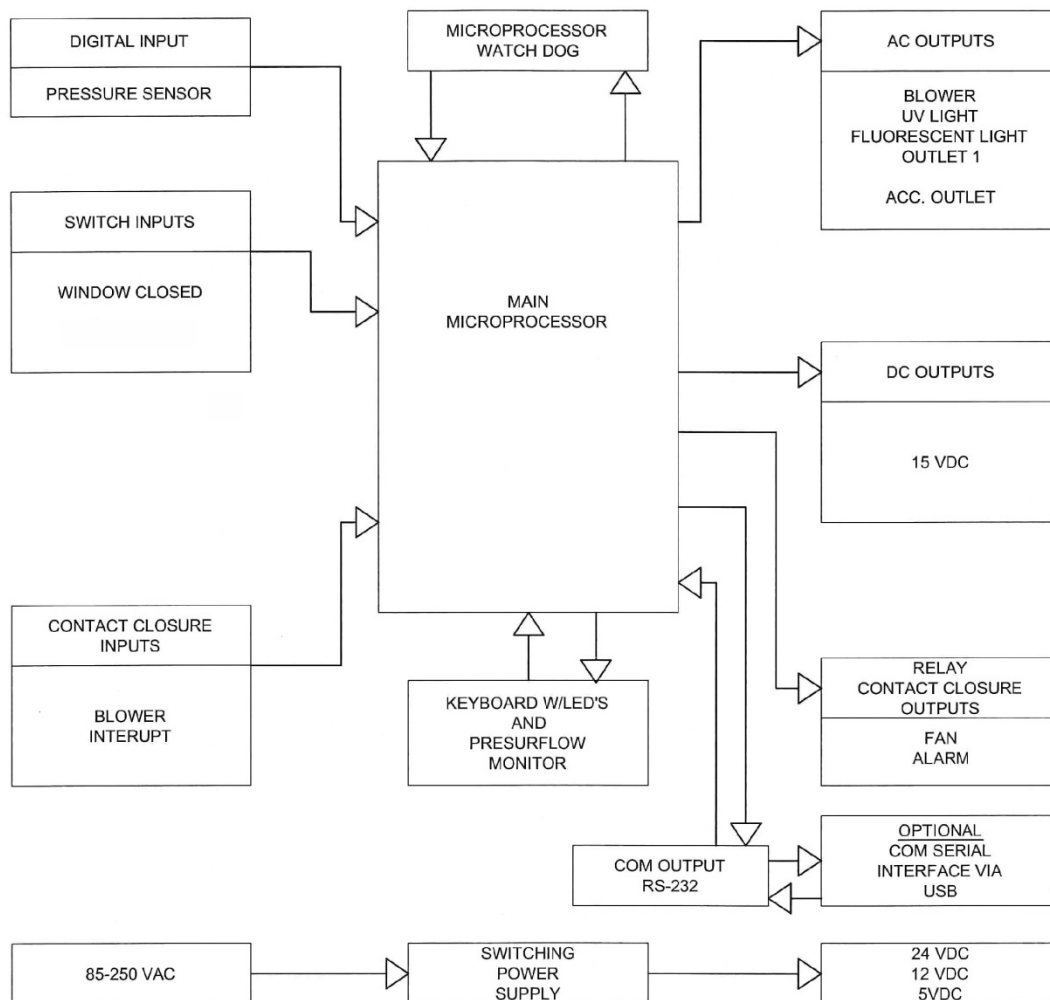

AEROMAX CONTROL SYSTEM BLOCK DIAGRAM

Figure 1

REV	ECO	DESCRIPTION	DATE	DFTM	CHKD
C	13471	UPDATED TITLE	8/25/2017	TH	BP



 ORIGINAL						
TITLE AEROMAX FRONT PANEL						
DFTM	DATE	CHKD	SHEET	1	OF	1
LS	12/16/2013	BP				
DRAWING NUMBER		BCD-16521				C

5.1.2 Front Panel

The control system front panel contains the following functions described in detail (see Drawing BCD-16521).

5.1.2.1 Blower Keys

The blower key controls the ON/OFF power to the blower.
LED above key indicates: full green for blower on,
blinking green for blower pending and
full red for blower alarm.

5.1.2.2 Hidden Key

The hidden key is located just above the blower LED indicator centered in the airflow symbol. The hidden key is used for various functions including the blower password 3 key sequence if the option is activated.

5.1.2.3 Fluorescent Light Key

The fluorescent light key controls the on/off power to the fluorescent light.
LED above the key indicates full blue for fluorescent light on.

5.1.2.4 Ultraviolet (UV) Light Key (optional)

The UV light key controls the on/off power to the UV light.
LED above indicates full yellow for UV light on.

5.1.2.5 Outlet Keys (only used for service/diagnostics)

The outlet key controls the ON/OFF power to the outlets.
LED above indicates full blue for outlets on.

5.1.2.6 Red Alarm LED

The red alarm LED will indicate any alarm condition and remain indicating until the alarm condition is cleared.

5.1.2.7 Audible Alarm Silence

The audible alarm silence key allows user interaction to silence an audible alarm for a period of 15 minutes. After 15 minutes if the alarm condition still exists, the audible alarm will again sound. The audible alarm silence key also is used to exit all Aeromax™ user interaction menus.

5.1.2.8 Arrow Adjustment Keys

The arrow adjustment keys allow user interaction for various functions.

5.1.3 Aeromax™ Control System Power

After the AireGard™ ES NU-140E is plugged into the appropriate facility line power the control system will power up. The control panel will also indicate the power up status by blinking the red alarm LED. Pressing any key will acknowledge the power up status and turn off the blinking red alarm LED.

If a power interruption occurs, all control system functions, calibrations and parameters will be maintained and continue upon restoration of power. Just as the initial power up, the red alarm LED will blink to indicate power up status.

5.1.4 Standby Mode

When the NU-140E is not in use any of the function keys except the blower that initiates run mode may be turned on and off in standby mode.

5.1.5 Run Mode

Any time the blower run key is pressed with the hinged window at its correct operational height, the RUN MODE screen will be initiated. The Run Mode will start with the PresurFlow™ entering and approximate 3 minute warm up period. The PresurFlow™ LED indicators will blink and indicate the following sequence:

- 1st minute – Left and right Red LED's will blink
- 2nd minute – Left and right Green LED's will blink
- 3rd minute – Center 3 Green LED's will blink

Once the warm up period is complete, only one LED will indicate cabinet airflow status.

During the warm up period the cleaning process may begin.

5.1.6 Standby/Run Mode Alarms

If present, standby/run mode alarms will be both visual and audible, the red alarm LED oval will turn on. Audible alarms will produce an alarm tone for 30 seconds, then ring back for 2 seconds of every 5 seconds. Pressing the alarm silence key will silence the audible alarm for 15 minutes initially then will start the ring back function again.

The list below represents alarm types and their respective priority from the highest to lowest priority.



- 1) New Firmware Loaded
- 2) Internal Board Failure
- 3) Power on Reset
- 4) Airflow Pressure Alarm
- 5) Blower RPM Failure



 **Note:** The above messages are described in greater detail in section 7.

5.1.7 Operator Accessible Functions

5.1.7.1 Access and Navigation

To access the operator accessible functions,



- Press and hold the  key, then enter the 3 key sequence for the desired function, then release the  key and follow each instruction set.

 **Note:** Pressing the  key at any time will abort and exit the process without saving any changes made. Pressing the hidden key will accept all changes and exit.

5.1.7.2 Auto Timer Duration

Auto timer duration timers are countdown timers for the functions displayed once time is entered into a function. The timer will begin to countdown upon the start of that function (i.e. press light key to start timing the light). The LED indicator above the function key will start to blink indicating the timer function. If the LED indicator was full on, no timer function is present. As the timer expires the function will turn off.

- Select auto timer duration function
 - Outlets (Special option feature only)
Press and hold  key, then press hidden – outlet – outlet keys sequentially.

LED indicator above outlet will blink fast. Adjust desired time as described below.
 - Lights
Press and hold  key, then press hidden – light – light keys sequentially.
LED indicator above light will blink fast. Adjust desired time as described below.
 - UV Light (Diagnostic key use only)
Press and Hold  key, then press hidden – UV light – UV light keys sequentially.
LED indicator above UV light will blink fast.
Adjust desired time as described below.
- Low Flow Blower (Diagnostic key use only)

Press and hold  key, then press hidden-blower-blower keys sequentially.
LED indicator above Blower key will blink fast. Adjust desired time as described below.
 - Adjust countdown time
Press \uparrow or \downarrow keys to adjust time.
Time will change in 15 minute increments as shown on the PresurFlow™ LED segments below.



- Press hidden key to accept time and exit.
- Press  key at any time to abort and exit.

5.1.7.3 Blower Password

The blower on/off password allows the cabinet user to place a 3 key sequence requirement to turn the blower on or off.

The 3 key sequence for the blower password will be a combination of the hidden and blower keys.

- Select blower password

Press and hold  key, then press hidden – blower – hidden keys sequentially.
Red LED indicator above blower will blink fast.

- Select password

Press \uparrow or \downarrow key to scroll through the code choices below,

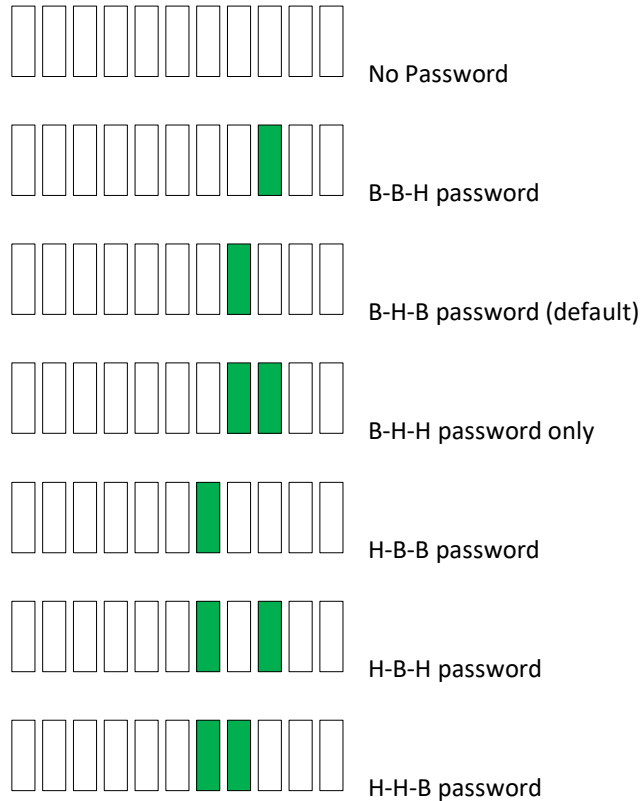

- Press hidden key to accept time and exit.
- Press  key at any time to abort and exit.

 **Note:** If the required blower password option is selected in the blower airflow option menu (see section 7.2.2). Then the “No password” choice above is not available and the default remains B-H-B.

5.2 Operating Guidelines

Operate the laminar flow workstation continuously. The unit will then remain in its initially clean condition. If, for any reason, the unit is turned off, turn the unit on and permit to operate for 5 minutes before resuming operations.

Allow only essential items in the work station. Objects should not be placed between the HEPA filter and any point where the clean environment must be maintained. New items introduced into the work area should be placed downstream of items already in the work zone for several minutes to allow contaminants to flush off. Note that plastic parts may carry a static charge which may require special handling in order to remove contaminants.

Particular care must be exercised in placing equipment within the work space. Where possible, equipment should be placed on perforated platforms to allow air movement under as well as around the object.

All work should be performed with the operator's hand or head downstream of the critical process points. Unnecessary movement with the work station should be kept to a minimum.

If the workstation is used in a manner not specified by NuAire, the protection provided by the equipment may be impaired.

5.2.1 Operating Sequence

A. Start Up

Turn on workstation blower and lights, check air intake ports of the workstation to make sure they are unobstructed. The workstations are provided with gauges which indicate pressure differentials across the filters. They indicate when to replace the filters, dependent upon the blower fan capacity. Blower speed must only be readjusted by qualified maintenance technicians.

B. Good procedure includes the decontamination or wipe down of workstation surfaces with chemical disinfectant before work commences.

C. Allow blowers to operate for a minimum of 5 minutes before aseptic manipulations are begun in the workstation. An additional advantage is obtained from purification (filtration) of the room air circulated through the equipment. Because of the characteristic contributed to the quality of the laboratory environment, some owners leave them in operation beyond the time of actual use.

D. Minimize Room Activity - Activity in the room itself should be held to a minimum. Unnecessary activity may create disruptive air currents, as well as interfere with the work of the operator. A person walking past the front of the workstation can cause draft velocities up to 175 FPM, which are sufficient to disrupt the air balance of the Laminar Flow Unit.

E. Utilize Unidirectional Airflow - The operator must keep two important facts in mind:

- 1) The air, as supplied to the work area through the HEPA filter is contaminant-free.
- 2) Airborne contamination generated in the work area is controlled by the unidirectional flow of parallel air streams.

A solid object placed in a laminar air stream will disrupt the parallel flow and consequently, the capability of controlling lateral movement of airborne particulates. A cone of turbulence extends behind the object and laminarity of the air stream is not regained until a point is reached downstream, approximately equal to three to six times the diameter of the object. Within the parameters of this cone, particles may be carried laterally by multidirectional eddy currents.

5.3 Ergonomics

Ergonomics, the study or accommodation of work practices is extremely important for proper workstation usage and user health and safety. An evaluation of normal work practices should be performed with each user when working in a workstation. Evaluation criteria should be at a minimum:

- a. Proper user posture
- b. Effective workzone layout for work practice
- c. Vision or sightlines

For each of the above evaluation criterion, several aids may be supplied to accommodate the user.

- Ergonomic chair - A six-way articulating seat and back control for personalized adjustment to assure proper user posture. Be sure feet are resting on the floor, chair foot support or foot rest. Also be sure back is fully supported with proper chair adjustments.
- Forearm/elbow support - The workstation is provided with a forearm support on the work access opening. Periodic mini-breaks during work practice should be taken resting forearm to avoid stress and fatigue. Elbow rests are optional that can provide support for particular work practices, such as pipetting.
- Effective workzone layout - Always prepare your work procedure to minimize reach to avoid neck and shoulder stress and fatigue. Rotating tables are optional to maximum workzone and minimize reach.
- Vision and sightline - Always prepare your work procedure to eliminate glare and bright reflections on the window. Keep your window clean and sightlines clear to your effect workzone.

5.4 Cleaning Procedures

5.4.1 General

Cleaning laboratory equipment is important in terms of both functionality and general good housekeeping. The information provided below is intended to aid the development of facility Standard Operating Procedures (SOP's) for cleaning the equipment. It is strongly recommended that all cleaning materials used be tested and verified in terms of both effectiveness and material compatibility before they are written into the cleaning SOP documentation.

a. The airflow blower should be operating during the cleaning process to maintain sterility and/or containment during the cleaning process.

b. Raise window to gain additional access if desired.

c. Apply appropriate cleaning material or surface disinfectant to surfaces. Most surface disinfectants require a specific contact time depending the materials used within the work zone. **CONSULT APPROPRIATE DISINFECTANT DOCUMENTATION FOR PROPER APPLICATION AND SAFETY PRECAUTIONS.**

c-1. Polycarbonate (Covestro® Makrolon®AR) has noted material compatibility concerns (see polycarbonate compatibility section). They recommend the use of Hydrogen Peroxide based materials such as the following:

- Steriplex SD
- Safetec surface wipes
- Peridox RTU

It is recommended to AVOID the use of cleaning materials that contain Chlorine, Quaternary Ammoniums and Phenol's.

If the polycarbonate is lightly scratched, it may be able to be polished out with Mirror Glaze Plastic Polish or similar.

Further information may be available from www.covestro.com

c-2. Stainless steel (type 304) has noted material compatibility concerns with Acids, Chlorides and Halogens. **IF THESE MATERIALS ARE USED AND ALLOWED TO BE LEFT ON THE STAINLESS STEEL SURFACE, OXIDATION AND DEGRADATION WILL OCCUR.** Only by re-wiping surfaces with either sterile water or 70% IPA will remove harmful materials from the stainless steel surface.

Further information is available at the following: http://www.parrinst.com/wp-content/uploads/downloads/2011/07/Parr_Stainless-Steels-Corrosion-Info.pdf

NOTE: NuAire does not offer any product warranty with respect to cleaning material compatibility. **USE AT YOUR OWN RISK!** The information provided above is from raw material suppliers and known general source documents for use to develop application cleaning SOP's.



NOTE: When cleaning the work area for the first several times, the new metal surfaces may produce some dark discoloration on the white cleaning wipes. Repeated cleaning will continuously reduce the amount of the discoloration material on the cleaning wipes over time.

6.0 General Maintenance



All maintenance actions on this equipment must be performed by a qualified technician who is familiar with the proper maintenance procedures required for this equipment. This includes both certification as well as repair.

6.1 Fluorescent/LED Lamp Replacement

The two (T8) fluorescent bulbs or optional LED lamps are cool white and placed external to the cabinet to aid maintenance and minimize heat build-up within the cabinet. The life rating of the bulb is 9,000 for fluorescent and 50,000 hours for LED based on three-hour burning cycles.

To replace a lamp, it is necessary to remove the lamp assembly.

1. Switch cabinet light switch off.
2. Remove the screws at each upper side of the control center and allow the control center to rotate down, resting on the safety straps.
3. The lamp is now directly exposed for replacement.
4. The lamp is removed by displacing the bulb to one side against the compressible bulb holder and lifting out the lamp.
5. Reverse the procedure to reinstall the lamp assembly being careful not to pinch the safety straps, cable or tubing during closure of the control center.

6.2 HEPA Filter Replacement

The HEPA filter, under normal usage and barring an accident (puncture), does not need replacement until the efflux velocity cannot be maintained at 90 LFPM (.457 m/s) \pm 10%. This may permit the HEPA filter efflux average to be as low as 81 LFPM (.411 m/s), as long as no point falls below 70 LFPM (.355 m/s). Use only replacement filters of the same rated flow and size as originally installed to insure proper airflow and HEPA filter lifetime can be achieved.

The HEPA Filter replacement procedure is performed by the following steps: Drawing BCD-19998):



Disconnect electrical power from the cabinet before attempting any maintenance action.

1. Close the window to fully closed position.
2. Remove flush mount front panel by removing (2) .250 x .500 10-24 shoulder bolts (1 each side top and lower control box).
3. Remove front pressure panel by removing 8-32 screws along top and bottom of panel.
4. Remove the front screw and tension spring assemblies across the front of the plenum (3 places).
5. Tip the plenum up and hang from hook located center of top header on the top panel.
6. Lift front of HEPA filter and remove.

 **NOTE:** This step usually requires 2 people for the removal and replacement of the HEPA filter.

7. Reverse procedure for installation and operation.
8. Reconnect unit power.

6.3 Pre-Filter Replacement

The replacement interval depends on the contaminant (large particles or lint) in the room -- a typical period is every 6 months. The prefilters are located on the top of the workstation.

6.4 Airflow Control System Setup and Calibration

6.4.1 General

The operation of the NU-140E requires that the setup and calibration procedures be performed in order to certify or commission for usage. The setup and calibration procedures performed **ONLY BY THE CERTIFIER** ensure that setpoints are verified and that the airflow monitor sensor is calibrated to the correct values.

6.4.2 Configuration Parameters

Configuration parameters identify NU-140E motor type and size for proper performance characteristics.

- Select/Verify model and size (**Bold items represent default parameters**)

- Press and hold  key, then press blower – blower – blower keys sequentially. LED indicates above both blower (red) and UV light keys will blink fast.

Review model type/size and change if desired as described below

- Press ↑ or ↓ keys to scroll through the LED segment choices associated with model type/size.

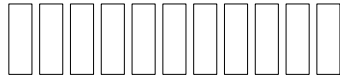

Class II, 3 foot

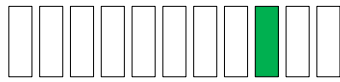

Class II, 4 foot

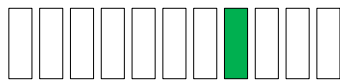

Class II, 5 foot

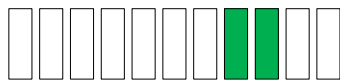

Class II, 6 foot

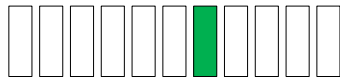

Laminar, 3/4 foot

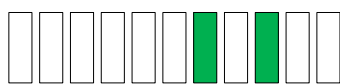

Laminar, 5/6 foot

- Press hidden key to accept model/size and exit
- Press  key at any time to abort and exit

- Select motor control function/type

- Press and hold  key, then press light – light – light keys sequentially. LED indicators above both blower (red) and light keys will blink fast.

Review motor control function/type and change it desired as described below.

- Press ↑ or ↓ keys to scroll through the LED segment choices associated with motor control function/type.



Auto DC ECM motor



Fixed duty DC ECM motor



Fixed duty EC Impeller motor

- Press hidden key to accept motor control function/type and exit
- Press  key at any time to abort and exit.

6.4.3 Airflow Calibration



Failure to calibrate airflow to the specified requirements may result in unsafe conditions of performance (i.e. product protection, noise and vibration)

The NU-140E Airflow Calibration consists of adjusting the airflow.

THIS WORK SHOULD BE DONE ONLY BY A QUALIFIED TECHNICIAN WHO CAN MEASURE THE AIRFLOW WITH A SUITABLE VELOMETER. NuAire provides one adjustment to set the airflow within the cabinet.

This is: PWM signal adjust via calibration parameter menu.

The PWM signal or blower speed adjustment establishes the NU-140E total volume of airflow as well as makes up for filter resistance tolerances.

DC ECM motor PWM signal DC voltage should also be monitored and recorded upon final calibration. The DC voltage may be measured using a digital voltmeter. The two test points to measure DC ECM motor voltage are located on the DC motor connector on the main control board.

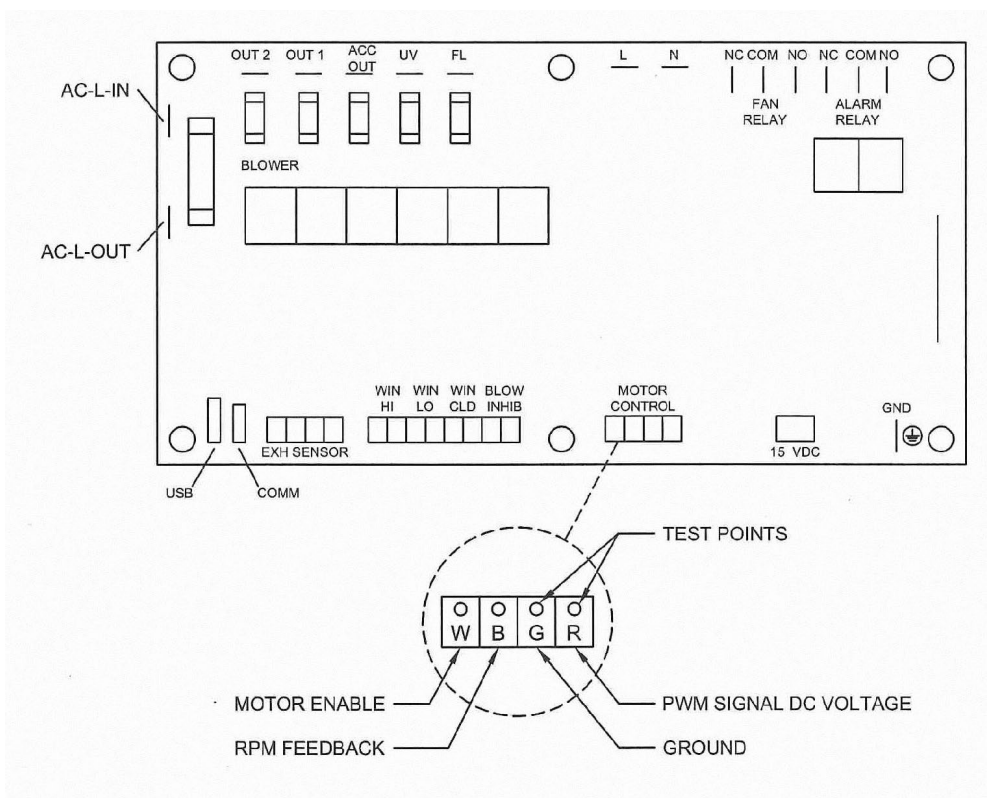

The NU-140E is considered to be certifiable if the following airflow measurements are present:

Inflow average: 90 LFPM \pm 10 LFPM (.46 m/s \pm 0.05 m/s) using the direct inflow measurement method or related value using the calculated inflow velocity measurement method.

BEFORE STARTING AIRFLOW CALIBRATION PROCEDURE, LET THE NU-140E RUN FOR AT LEAST 5 MINUTES.

6.4.3.1 Airflow Calibration

Step 1: Measure the inflow velocity using the recommended procedure found in Table 6.0. If necessary, adjust to achieve the correct average miniflow velocity within the stated range of 90 ± 10 LFPM ($.46 \pm 0.05$ m/s).

Step 2: If necessary, enter active blower speed adjustment.

- Press and hold  key, then press hidden – blower - \uparrow keys sequentially. LED indicator above blower (green) key will blink fast.

Step 3: Press \uparrow or \downarrow keys to adjust blower speed.

- LED segments will indicate blower speed percentage and active blower speed adjustment



- Right end red LED indicates active blower speed adjust
The red LED will blink as soon as any adjustments are made and will continue to blink as the motor rpm settles. Once the red LED stops blinking, the motor will run steady state at the new percentage.

Note: The red LED must be non-blinking to save or exit

- Green LED's indicate percentage on of scale (0-100%)
- Yellow LED's indicate minimum (left/maximum (right) blower speed has been achieved

 **Note: At any time during the process**

- **Press hidden key to accept and enter the blower speed calibration point (If the blower speed calibration point was not successfully entered; a half second audible alarm will occur. The calibration process must then be repeated for successful entry of blower speed calibration point.)**
- **Press  key to abort and exit**

6.4.3.2 PresurFlow™ Alarm Set Points

The PresurFlow™ alarm setpoints are based on the calibration setpoint. Once the calibration setpoint is entered, based on a nominal inflow velocity of 90fpm (.46mls) the associated pressure sensor value is entered as the nominal pressure value. **The high and low alarm setpoints are factory verified and set if needed at 90LFPM (.46 m/s).**

However, if specific use alarm setpoints are desired, the alarm setpoints may be adjusted by performing the following:

Low Alarm Setpoint

- Press and hold the hidden and \downarrow key for 3 seconds.
(The left red LED will blink and the green LED's indicate blower speed)
- Press \uparrow or \downarrow keys to adjust blower speed to the desired airflow velocity low alarm setpoint value.



- Left end red LED indicates active low limit blower speed adjust
The red LED will blink as soon as any adjustments are made and will continue to blink as the motor rpm settles. Once the red LED stops blinking, the motor will run steady state at the new percentage. If the low alarm setpoint value is not within an acceptable range, the left end red LED will blink at a very fast rate.

Note: The red LED must be non-blinking to save or exit.



Note: At any time during the process

- **Press hidden key to accept low alarm setpoint value**
- **Press and hold outlet key for three seconds to remove any previous offsets**
- **Press  key to abort and exit**
- Upon exiting, the blower will go back to actual airflows.

High Alarm Setpoint

- Press and hold the hidden and ↑ key for 3 seconds.
(The right red LED will blink and the green LED's indicate blower speed)
- Press ↑ or ↓ keys to adjust blower speed to the desired airflow velocity high alarm setpoint value.





- Red end Red LED indicates active high limit blower speed adjust.
The red LED will blink as soon as any adjustments are made and will continue to blink as the motor rpm settles. Once the red LED stops blinking, the motor will run steady state at the new percentage. If the high alarm setpoint value is not within an acceptable range, the right end red LED will blink at a very fast rate.

Note: The red LED must be non-blinking to save or exit.



Note: At any time during the process



- Press hidden key to accept low alarm setpoint value
- Press and hold outlet key for three seconds to remove any previous offsets
- Press  key to abort and exit
- Upon exiting, the blower will go back to actual airflows.

 **Note:** Specific use alarm setpoints or the offset pressure value from the nominal calibration point will be maintained with a new nominal calibration value.

It is not necessary to re-enter the alarm setpoints after a nominal calibration.

6.4.3.3 PresurFlow Alarm Verification

The PresurFlow Alarm setpoints are based on the calibration setpoint. Once the calibration setpoint is entered, the Alarm setpoint offset pressure values will align from the calibration pressure value. The high or low alarm setpoint can be verified by measuring inflow volume/velocity while adjusting blower up or down within the Alarm Verification menu.

- Press and hold  key, then press ↑ ↓ ↑ sequentially releasing the  key after the 3 key sequence.
- Note: If blower was off while entering into the Alarm Verification Menu, the low alarm limit will immediately activate. Turn on blower; once airflow is above the low alarm limit, the alarm will turn off.
- LED segments will indicate blower speed percentage.

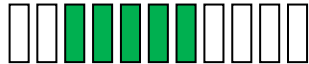

- Press ↑ or ↓ key to raise or lower blower speed. Alarm is active so yellow and red LED's will activate if pressure reaches the low or high alarm limit.
- Press  to exit (blower should turn off and not go through normal start up procedure).

Table 6.0

Airflow Velocity Profile

A. Instruments: TSI 8355 Thermo anemometer

B. Procedure:

Air velocity readings are taken on a 12 inch (305mm) grid, in a plane parallel to and 6 inches (152mm) from the diffuser. No reading should be taken closer than 6 inches (152mm) from the inner edge of the filter frame.

C. Test Data:

Number of Readings:	Average Velocity:	ft./min. m/s
---------------------	-------------------	--------------

D. Acceptance Criteria:

1. Average Velocity = **80 to 100 fpm (.41 to .51 m/s)**
2. Individual Readings must be within ± 20 percent of the average velocity

_____ to _____ fpm (_____ to _____ m/s).

6.5 HEPA Filter Leak Test

In order to check filter and filter seal integrity, the HEPA filter media and seals must be directly accessible, by the measuring instrument. The challenge material (i.e. PAO) should be supplied in the top panel of the workstation. An upstream challenge may be taken by using the minihelic gauge pressure supply tube if desired.

The diffuser is secured by thumb screws on the sides.

Once removed the diffuser can be dropped down and carefully removed from the cabinet.

<u>Model Size</u>	<u>Filter Area (ft²)(m²)</u>
330	5.59 (.519)
430	7.57 (.703)
530	9.55 (.887)
630	11.52 (1.07)

To measured 6 inches below the diffuser

Laskin Nozzle Concentration Formula

$$\frac{\# \text{ Nozzles} \times 135 \text{ CFM} \times 100 \text{ ug/L}}{\text{CFM}} = \text{Challenge Concentration (ug/L)}$$

$$\frac{\# \text{ Nozzles} \times 229 \text{ CMH} \times 100 \text{ ug/L}}{\text{CMH}} = \text{Challenge Concentration (ug/L)}$$

Calculated Reference Concentration							
NU-140		Airflow, FPM [mps]					
Size	Filter Area ft ² [m ²]	80	[0.406]	90	[0.457]	100	[0.508]
		Challenge (ug/L)					
330	5.59 [.519]	30		27		24	
430	7.57 [.703]	22		20		18	
530	9.55 [.887]	18		16		14	
630	11.52 [1.07]	15		13		12	

All calculations use 1 Laskin Nozzle PAO @ 23 PSI

6.6 Cleanliness Classification Test for Pharmacy Application

If this cabinet is going to be used within pharmacy, per USP797¹, the cabinet must be tested to assure compliance to ISO 14644-1:2015, Cleanrooms and Associated Controlled Environments, Part 1: Classification of Air Cleanliness². The cleanliness classification test is performed using a particle counter to measure particle counts within the cabinet workzone. Turn on cabinet and let warm up for several minutes. Turn on particle counter and flush out sample tubing line to remove latent particles. Set the particle counter to measure 0.5 micron or larger particles at the appropriate measuring rate.

“Operational Particle Count Test”³

Position the particle counter isokinetic probe at a point 6 inches (152mm) upstream of the aseptic manipulation area (hand convergence point) and mounted so as not to interfere with the operator’s hand movement. The pharmacy operator will simulate IV manipulation during the particle count test using non-hazardous materials. A minimum of three (3) 1-minute particle counts shall be sampled and recorded while the user simulates aseptic compounding manipulations.

“At Rest Particle Count Test”

Take 5 test points in 1-minute intervals on a grid, in a Vertical plane as measured approximately 6-inches (152mm) parallel to the diffuser. The grid location is designed as the diffuser center point and each corner measured 6-inches (152mm) from the inside perimeter.

Record the 5 particle count values for each of the test points over the 1-minute sample time. All final count particle concentrations and calculated 95% upper confidence limit shall not exceed 3520 particles per cubic meter (ppcm) or (100 particles per cubic feet (ppcf)).

¹ USP28-NF23: United States Pharmacopeial Convention, Inc., 12601 Twinbrook Parkway, Rockville, MD 20852, USA, www.usp.org.

² ISO 14644-1:2015 Cleanrooms and Associated Controlled Environments-Classification of Air Cleanliness, International Organization for Standardization, Case Postale 56, CH-1211 Geneve 20, Switzerland

³ CAG-002-2006: CETA Compounding Isolator Testing Guide, Controlled Environment Testing Association, 1500 Sunday Drive, Suite 102, Raleigh, NC 27607, USA, www.cetainternational.org

6.7 Main Control Board Description and Replacement

To access the main control board for fuse or board replacement, remove (1) rear screw at each top side of the top panel and pull out panel to access. Now the main control board is exposed for service.

6.7.1 Main Control Board Replacement

The main control board consists of one Printed Circuit Board (PCB) assembly.

The PCB contains the power supply, configuration switch, sensor inputs/outputs and control inputs/outputs components and display.

6.7.2 Main Control Board Fuse Replacement



Disconnect electrical power before fuse replacement.

All AC circuits are fuse protected and when replacement is necessary, USE ONLY FUSES OF SAME TYPE AND RATING FOR PROTECTION AGAINST RISK OF FIRE.

DESCRIPTION:	BLOWER FUSE	OUTLET FUSE (Option Only)	ACCESSORY OUTPUT FUSE (Option Only)	LIGHT FUSES
FUSE TYPE:	TIME-LAG	TIME-LAG	TIME-LAG	TIME-LAG
FUSE SIZE:	1/4 X 1-1/4 INCH	5 X 20MM	5 X 20MM	5 X 20MM
NU-140-330E	5 AMPS	3 AMPS	2 AMPS	1 AMP (2)
NU-140-430E	6.25 AMPS	3 AMPS	2 AMPS	1 AMP (2)
NU-140-530E	6.25 AMPS	3 AMPS	2 AMPS	1 AMP (2)
NU-140-630E	6.25 AMPS	3 AMPS	2 AMPS	1 AMP (2)

6.7.3 Main Control Board Replacement

Note: All setup and calibration data will be lost, the memory reinitialized to the default values and all control functions reset to an initial cabinet power condition.

If possible, before the main control board replacement, it would be preferred to know the operational parameters of the cabinet, (i.e. blower speed/PWM signal DC voltage setpoints if modified and airflow data from previous certification).

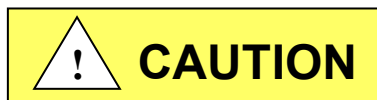

Disconnect electrical power before attempting any maintenance action.

The main control board is fastened to the control center with (6) 6-32 studs/nuts. All electrical connections are made with removable terminals and/or Faston connectors except for the motor/blower connector which uses a screw terminal. Remove all electrical connections and fasteners and then remove the main control board from the control center.

Install new main control board by reattaching all electrical connections and fasteners. Once installed, rotate control center to normal position and fasten in place. Reconnect power to cabinet.

7.0 Error Messages, Troubleshooting, Option-Diagnostics and Airflow Sensor Performance Verification

Audible alarms and error messages occur for a variety of reasons. Whenever an alarm condition has been present for a period of at least 10 seconds, the audible alarm/error message will be presented and stay on until the error is cleared. The audible alarm will be on for 30 seconds upon initial alarm condition, then once every ten seconds. When presented with an error message, please perform the following:

Step 1: NOTE ALL ERROR MESSAGES.

Error message will appear on the control panel with red LED's.

Step 2: VERIFY ERROR MESSAGES.

Error messages can be verified by clearing the error function by either turning the blower or the cabinet on and off.

Step 3: MONITOR RE-OCCURRENCE OF ERROR MESSAGES.

If re-occurrence of the error message is immediate or daily, use the following guide to correct the situation.

7.1 Error Message Troubleshooting Guide

Issue	Error Description	Correction
Cabinet fluorescent lights won't Turn on	Blue LED above light key indicates the lamp should be on.	Check light fuse on main control board. Check fluorescent lamps. Check voltage coming out of main control board to light ballasts. Check light starters, if present. Check ballast.
Cabinet blower won't turn on.	Green LED above blower key indicates the blower should be on. Airflow Alarm.	Check blower fuse on main control board. Check AC voltage coming out of main control board. Check wiring to blower. Check blower motor. Check DC motor PWM signal on main control board.
Red alarm LED blinks	Indicates a power interruption has occurred.	Press any key to clear.
Cabinet ultraviolet light won't turn on.	Yellow LED above UV light key indicates the UV lamp should be on.	Check sliding window position; should be fully closed. Check blower/lights fuse on main control board. Check voltage coming out of the main control board to ultraviolet light ballast. Check ballast.
UV LED blinks fast and red LED alarm.	Indicates that the UV light needs replacement.	Replace UV light and clear UV run time clock.
Blower or light fuse continues to blow after replacement.	N/A	Check for short on output of fuse. Isolate output of fuse by disconnecting control center connectors, light circuit, AC or DC blower circuit, etc. to isolate the short.
PresurFlow™ left red LED indicator on and red LED alarm	PresurFlow™ reading low flow (pressure)	Check airflow values. Check blower function. Recalibrate PresurFlow™ system.
PresurFlow™ right red LED indicator on and red LED alarm	PresurFlow™ reading high flow (pressure)	Check airflow values. Recalibrate PresurFlow™ system.
All PresurFlow™ LED's blink	Message acknowledges new firmware was loaded into microprocessor	N/A
Blower red LED blinks and red LED alarm	Indicates that the motor rpm signal has been interrupted	Check connectors and wires from main control board to the motor Replace motor if required

7.2 Option Parameters

The option parameter menu allows **A QUALIFIED TECHNICIAN** to configure several different optional parameters per the menu as described below.

7.2.1 Sync Function with Active Blower

To access the option parameter menu, perform the following:

- Press and hold  key, then press hidden - Blower - Fluorescent keys sequentially. Red LED indicator above the blower key will blink fast

The PresurFlow™ blinking green LED segments will indicate seven optional parameters as shown and described below. The UV Light key (move left) and outlet key (move right) allows selection of the option parameter desired.

Once the desired option parameter is indicated, press \uparrow or \downarrow key to turn on or off. A slow blinking green LED indicator means off and a fast blinking green LED indicator means on. Multiple option changes can be selected.

- Pressing the hidden key will accept all changes and exit
- Pressing the  key will abort the process and exit

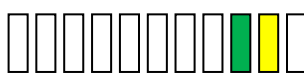

Sync Fan Relay with Active Blower -

Normally the fan relay will activate when the blower switch is pressed. Blower can either be actively running or pending. If the fan relay sync is active the blower must be actively running for the relay to change state.



Sync Accessory Outlet with Active Blower - (only usable if accessory outlet is installed)

Normally the accessory outlet is on all the time. If the accessory outlet sync is active, the blower must be actively running for the accessory outlet to turn on.



Sync Outlet Power with Active Blower -

Normally the outlet power is turned on via the outlet key. If the outlet power sync is active, the outlet power will turn on and off with the blower or may be turned on and off independently if the blower is active.



Sync Fluorescent Light with Active Blower -

Normally the fluorescent light is turned on via the fluorescent light key. If the fluorescent light sync is active, the fluorescent light will turn on and off with the blower or may be turned on and off independently if the blower is active.



Sync 15 Volt DC output with active blower normally the 15 Volt DC output located on the control board is on when power is applied to the system. If the 15 Volt DC output sync is active, the blower must be actively running for the 15 Volt DC output to turn on.

7.2.2 Blower/Airflow Options

To access the option parameter menu, perform the following:

- Press and hold  key, then press hidden - \uparrow and \downarrow keys sequentially. Red LED indicator above the blower key will blink fast

The PresurFlow™ blinking green LED segments will indicate seven optional parameters as shown and described below.

The UV Light key (moves left) and outlet key (moves right) allows selection of the option parameter desired.

Once the desired option parameter is indicated, press \uparrow or \downarrow key to turn on or off. A slow blinking green LED indicator means off and a fast blinking green LED indicator means on. Multiple option changes can be selected.

- Pressing the hidden key will accept all changes and exit
- Pressing the  key will abort the process and exit



Require Password –

Normally it is not required to use a password (i.e. 3 key press sequence of the blower and hidden key). If the option is turned on, it would be required to use the correct password to turn on the blower. The default password once turned on is blower-hidden-blower keys in sequence. The password can be changed in the blower password option menu.

Note: If turning off the password option, you must also select the no password menu item (see section 5.1.8.3)



Allow UV light anytime – (only if option is installed)

Normally the UV light is interlocked with the window being in the closed position.

For service purposes only, if the function is active, the UV light may be turned on at any window height.



Note: In addition to the Allow UV light anytime system function, there is a double redundant UV light window interlock relay. To override the UV light window interlock relay, the relay itself must also be shorted. (See electrical schematic for reference).



Manual Blower Restart –

Normally when the blower is actively running and a power interruption occurs.

The blower will automatically come back on when power is restored. If this function is turned off, the blower will not automatically come back after a power interruption, but would require the user to press the blower key to restart the blower.



Low Flow –

Normally the function is turned off. If selected and turned on, once the blower is actively running. Upon closure, the blower will continue to run at a calibrated lower speed level to maintain a negative airflow. The PresurFlow™ will indicate(s) blinking green LEDs along with green LED above blower key.



Disable PresurFlow™ -

If this function is active, the digital pressure sensor and alarm function are turned off.



Temporary Low Flow -

When this option parameter is turned on and the other requirements below are met, the blower key (when held for 5 seconds) will toggle blower between normal and Low Flow blower speed. The Low Flow blower will time out, based on the Auto Timer duration for Low Flow without a blower key press and the blower speed will revert back to normal.

In addition to turning this option on the following requirements must also be met

- Temporary Low Flow Option must be selected
- Password Option must be selected
- Window is at normal height and blower is running
- Low Flow Option must be selected
- Low Flow blower auto timer must be set for a minimum of 15 minutes.



Disable audible alarms / audible key feedback

Normally audible alarms from the PresurFlow™ monitor and audible key feedback are present to provide an audible sound to the user. If this function is active, all audible sound will be silenced when the control system is in normal run mode. Audible sound will still occur in any service/calibration menu function.

Environmental resistance of Makrolon® polycarbonate sheet

Makrolon® POLYCARBONATE SHEET IS RESISTANT AT 70°F AND 0% STRAIN TO:

CHEMICALS:

Amyl Alcohol	Chromic Acid (20%)	Lactic Acid (20%)	Potassium Bromate	Sodium Chloride
Aluminum Chloride	Citric Acid (40%)	Magnesium Chloride	Potassium Bromide	Sodium Hypochlorite
Aluminum Sulfate	Copper Chloride	Magnesium Sulfate	Potassium Nitrate	Sodium Sulfate
Ammonium Chloride	Copper Sulfate	Manganese Sulfate	Potassium Perchlorate	Stannous Chloride
Ammonium Nitrate	Formic Acid (10%)	Mercuric Chloride	Potassium Permanganate	Sulfur
Ammonium Sulfate	Formalin (30%)	Nickel Sulfate	Potassium Persulfate	Sulfuric Acid (10%)*
Antimony Trichloride	Glycerine	Nitric Acid (10%)	Potassium Sulfate	Sulfuric Acid (50%)
Arsenic Acid	Heptane	Nitric Acid (20%)	Silicone Oil	Tartaric Acid (30%)
Butyl Alcohol	Hydrochloric Acid (10%)	Oleic Acid	Silver Nitrate	Zinc Chloride
Calcium Nitrate	Hydrogen Peroxide (30%)	Oxalic acid	Sodium Bicarbonate	Zinc Sulfate
Chlorinated Lime Paste	Hydrofluoric Acid (10%)	Pentane	Sodium Bisulfate	
Chrome Alum	Isopropanol	Phosphoric Acid (10%)	Sodium Carbonate	

*Sulfuric Acid at 1% attacks polycarbonate sheet

COMMON HOUSEHOLD MATERIALS Makrolon® POLYCARBONATE IS RESISTANT TO:

CHEMICALS:

Borax	Joy Liquid Detergent	Rum
Cocoa	Insulating Tape	Salad Oil
Cement	Linseed Oil	Salt Solution (10%)
Chocolate	Liquor	Soap (Soft/Hard)
Cod Liver Oil	Milk	Table Vinegar
Cognac	Mineral Water	Tincture of Iodine (5%)
Coffee	Mustard	Tomato Juice
Detergents	Olive Oil	Vodka
Fish Oil	Onions	Washing Soap
Fruit Syrup	Orange Juice	Water
Grapefruit Juice	Paraffin Oil	Wine
Gypsum	Rapeseed Oil	

PETROLEUM PRODUCTS Makrolon® POLYCARBONATE SHEET IS RESISTANT TO:

Compressor Oil	Spindle Oil
Diesel Oil	Transformer Oil
Kerosene	Vacuum Pump Oil
Refined Oil	

Note: Elevated temperature and/or strain significantly alters resistance to industrial petroleum products.

LIMITED RESISTANCE AT 70°F AND 0% STRAIN TO:

Antifreeze	Hydrochloric Acid (conc.)
Calcium Chloride	Milk or Lime (CaOH)
Cyclohexanol	Nitric Acid (conc.)
Ethylene Glycol	Sulfuric Acid (conc.)

Makrolon® POLYCARBONATE SHEET IS NOT RESISTANT TO:

CHEMICALS:

Acetaldehyde	Benzyl Alcohol	Chlorobenzene	Formic Acid (conc.)	Phosphorus Trichloride
Acetic Acid (conc.)	Brake Fluid	Chlorothene	Freon (refrigerant/propellant)	Propionic Acid
Acetone	Bromobenzene	Cutting Oils	Gasoline	Sodium Sulfide
Acrylonitrile	Butylic Acid	Cyclo Hexanone	Lacquer Thinner	Sodium Hydroxide
Ammonia	Carbon Tetrachloride	Cyclohexene	Methyl Alcohol	Sodium Nitrate
Ammonium Fluoride	Carbon Disulfide	Dimethyl Formamide	Nitrobenzene	Tetrahydronaphthalene
Ammonium Hydroxide	Carbolic Acid	Ethane Tetrachloride	Nitrocellulose Lacquer	Thiophene
Ammonium Sulfide	Caustic Potash Sol. (5%)	Ethylamine	Ozone	Toluene
Benzene	Caustic Soda Sol. (5%)	Ethyl Ether	Phenol	Turpentine
Benzoic Acid	Chloride	Ethylene Chlorohydrin	Phosphorus Hydroxy	Xylene

Makrolon® POLYCARBONATE SHEET IS DISSOLVED BY:

Chloroform, Cresol, Dioxane, Ethylene Dichloride, Methylene Chloride, Pyridine

EFFECTS OF MOISTURE ON Makrolon® POLYCARBONATE SHEET:

Makrolon Polycarbonate Sheet has good resistance to water up to approximately 150°F. Above this temperature, the effect of moisture is time-temperature related. Exposing Makrolon Polycar-

bonate Sheet to repeated steam cleaning or dishwashing can create hydraulic crazing. The result can be a clouding of the surface and ultimately a loss of physical strength properties.

9.0 Remote Contacts

The NU-140E has several contact closures for remote sensing of various functions.

9.1 Fan Relay

The fan relay contacts are normally open and closed contact closure outputs that are activated whenever the blower key is pressed and the blower key LED indicator is on or blinking. Contact ratings are 250 VAC maximum at 2 Amps.

9.2 Alarm Relay

The alarm relay contacts are normally open and closed contact closure outputs which are activated whenever an airflow alarm condition occurs. Contact ratings are 250 VAC maximum at 2 Amps.

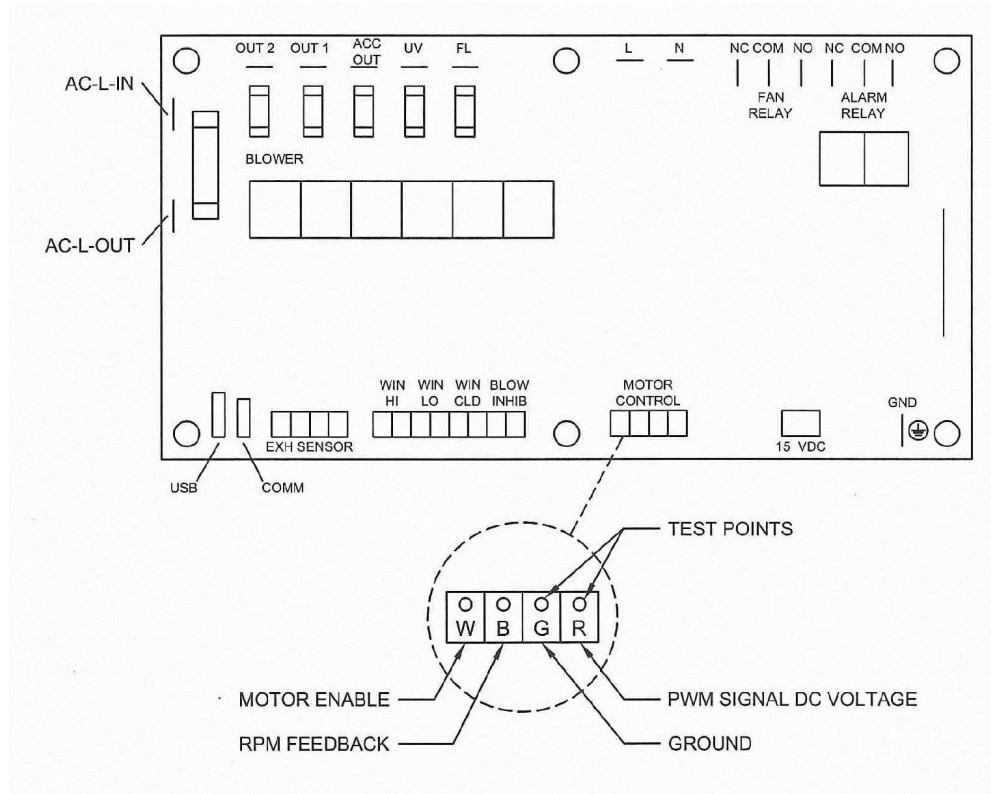

9.3 15VDC Output

The 15VDC (100mA) output is generated if the blower is actively running.

10.0 Optional Equipment

10.1 Ultraviolet Light



Ultraviolet light will injure your eyes. Avoid direct viewing at all times. Personnel should not be present when ultraviolet lamp is on

10.1.1 Overview

The germicidal ultraviolet is primarily intended for the destruction of bacteria and other microorganisms in the air or on directly exposed surfaces. Approximately 95% of the ultraviolet radiations from germicidal tubes are in the 253.7 nanometer region. This is a region in the ultraviolet spectrum which is near the peak of germicidal effectiveness. The exposure necessary to kill bacteria is the product of time and intensity. High intensities for a short period of time, or low intensities for a longer period are fundamentally equal in lethal dosage on bacteria (disregarding the life cycle of bacteria). The intensity of light falling on a given area is governed by the inverse law; that is the killing intensity decreases as the distance increases from the tube.

The germicidal tube is placed in the cabinet to provide an average intensity of 100 microwatts per centimeter (for a new tube) falling on a horizontal plane defined by the bottom of the work surface. The minimum requirement per paragraph 5.12 of NSF Standard 49 is 40 microwatts per square centimeter (ref. NSF Std. #49, June, 1976).

Since ultraviolet rays will not penetrate ordinary glass, it is recommended that the sliding window be closed while the ultraviolet light is on within the cabinet; or that personnel leave the cabinet face area.

10.1.2 Operation

The operation of the ultraviolet light is accomplished by closing the sliding window and pressing the UV switch located on the front panel. The sliding window is interlocked to the ultraviolet light so, when the sliding window is raised, the ultraviolet light will turn off. If operational time duration is known, the timer can be used in conjunction with the ultraviolet light to time out the ultraviolet light operation. This can be accomplished by first turning on the ultraviolet light. Then, set the timer to the desired length of ultraviolet light operation time. Upon timer expiration, the ultraviolet light will turn off.

10.1.3 Precaution

The rays from germicidal tubes may cause a painful but temporary irritation of the eyes and reddening of the skin, if of sufficiently high intensity, or if exposure covers a prolonged period of time. For this reason, one should avoid direct eye and skin exposure to ultraviolet light. If exposure cannot be avoided, it is necessary for personnel to wear eye goggles or face shields, and long sleeve gowns with rubber gloves.

Since ultraviolet rays will not penetrate ordinary glass, it is recommended that the sliding window be closed while the ultraviolet light is on within the cabinet; or that personnel leave the cabinet face area.

10.1.4 Maintenance

The output of an ultraviolet light deteriorates with burning age. The useful life of the light is approximately 5000 hours under specific test conditions.

The control system monitors UV light usage hours and when the 5000 hour point is reached. The UV light LED indicator will blink fast along with the red LED alarm indicating the UV light should be replaced. To reset the timer, perform the following:

- Press and hold  key the press UV light – UV light – UV light key sequentially and the reset will occur removing the above alarm condition.
-

It is also possible to approximate the UV light usage by the following:

- Press and hold  key and UV light key together for three seconds. The PresurFlow™ LED's will then indicate usage of approximately 450 hours per LED light from left to right.

 Indicates approximately 450 hours used

 Indicates approximately 900 Hours used

 Indicates approximately 3600 hours used

 **Note:** Before testing with lamp off, the light may be cleaned with a lint-free cloth dampened with alcohol or ammonia and water.

Energies Required to Destroy Some Microorganisms by Ultraviolet Radiation (e)

Mold Spores	Microwatt seconds per cm/2	Protozoa	Microwatt seconds per cm/2
Penicillium roqueforti	26,400	Paramecium	200,000(a)
Penicillium expansum	22,000		
Penicillium digitatum	88,000	Nematode Eggs	40,000(b)
Aspergillus glaucus	88,000		
Aspergillus flavus	99,000	Algae	22,000(c)
Aspergillus niger	330,000		
Rhizopus nigricans	220,000	Virus	
Mucor racemosus A	35,200	Bacteriophage (E. Coli)	6,600
Mucor racemosus B	35,200	Tobacco Mosaic	440,000
Oospora lactis	11,000	Influenza	3,400(d)
Yeasts			
Saccharomyces	13,200		
ellipsoideus	17,600		
Saccharomyces cerevisiae	13,200		
Brewers' yeast	6,600		
Baker's yeast	8,800		
Common yeast cake	13,200		
Bacteria			
Streptococcus lactis	8,800		
Strep. hemolyticus (alpha type)	5,500		
Staphylococcus aureus	6,600		
Staphylococcus albus	5,720		
Micrococcus sphaeroides	15,400		
Sarcina lutea	26,400		
Pseudomonas fluorescens	7,040		
Escherichia coli	7,040		
Proteus vulgaris	7,480		
Serratia marcescens	6,160		
Bacillus subtilis	11,000		
Bacillus subtilis spores	22,000		
Spirillum rubrum	6,160		

References:

- (a) Luckiesh, Matthew (1946) Application of Germicidal, Ethymal and Infrared Energy, D. Van Nostrand o., New York, New York, pp 253
- (b) Hollaender (1942) Aerobiology, A.A.A.S. (for 90% inactivation), pp 162
- (c) Ellis, C. and Wells, O.O. (1941) The Chemical Action of Ultraviolet Rays, Reinhold Publishing Corp., pp. 713-714
- (d) Hollaender, A., Oliphant, J.W. (1944)
The inactivation effect of monochromatic ultraviolet. Radiation on Influenza Virus (for 90% inactivation) Jour. of Bact. 48, pp. 447-454
- (e) This table, "Energies Required to Destroy Some Microorganisms by Ultraviolet Radiation's" comes from Westinghouse brochure entitled - "Westinghouse Sterilamp Germicidal Ultraviolet Tubes"

11.0 Electrical/Environmental Requirements

11.1 Electrical (Supply Voltage Fluctuations Not to Exceed +/- 10%)

<u>Electrical</u>	<u>Voltage</u>	<u>Phase</u>	<u>Frequency</u>	<u>Current (Amps)</u>	<u>Independent Outlet Current for Each Outlet (Optional, Amps)</u>
NU-140-330E	230 Volts	1	50/60 Hz	5	10
NU-140-430E	230 Volts	1	50/60 Hz	6	10
NU-140-530E	230 Volts	1	50/60 Hz	6	10
NU-140-630E	230 Volts	1	50/60 Hz	6	10

11.2 Operational Performance (for indoor use only)

Environment Temperature Range: 60°F - 90°F (15.6°C - 32.2°C)

Environment Humidity: Maximum relative humidity 80% for temperatures up to 31°C decreasing linearly to 50% relative humidity at 40°C

Environment Altitude: 6562 Feet (2000 Meters) maximum

11.3 Light Exposure

Standard Fluorescent Lighting @ 150 ft. candles (1614 LUX) maximum intensity.

11.4 Installation Category: 2.0

Installation category (overvoltage category) defines the level of transient overvoltage which the instrument is designed to withstand safely. It depends on the nature of the electricity supply and its overvoltage protection means. For example, in CAT II, which is the category used for instruments in installations supplied from a supply comparable to public mains such as hospital and research laboratories and most industrial laboratories, the expected transient overvoltage is 2500V for a 230V supply and 1500V for a 120V supply. Main supply fluctuations are not to exceed $\pm 10\%$ of nominal voltage.

11.5 Pollution Degree: 2.0

Pollution degree describes the amount of conductive pollution present in the operating environment. Pollution degree 2 assumes that normally only non-conductive pollution such as dust occurs with the exception of occasional conductivity caused by condensation.

11.6 Chemical Exposure

Chemical exposure should be limited to antibacterial surface disinfectants used for cleaning and disinfecting. USE OF CHLORINATED OR HALOGEN MATERIALS IN THE CABINET MAY DAMAGE STAINLESS STEEL. Equipment decontamination can be accomplished by non-condensing gas or vapor Paraformaldehyde, Hydrogen Peroxide or Chlorine Oxide following NSF/ANSI 49, Annex G.

11.7 EMC Performance (classified for light industrial)

Emissions: EN61326

Immunity: EN61326



The EMC performance requirements are generated within the product enclosure. The enclosure will be all metal grounded to earth.

In addition, the membrane front panel will also include a ground plane for maximum protection and an electrostatic shield.

12.0 Disposal and Recycle

Workstations that are no longer in use and are ready for disposal contain reusable materials. ALL components may be disposed and/or recycled after they are known to be properly disinfected.

 **NOTE:** Follow all local, state and federal guidelines for disposal of HEPA filter solid waste.

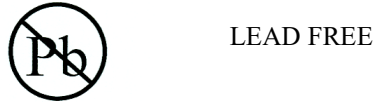

Component

Main Workstation
Worksurface
Side Panels
HEPA Filter Frame
Control Center
Diffuser
HEPA Filter
Hepex Bag
Blower Wheel & Housing
Motor
Printed Wiring Assembly
Wire
Ballasts
Connectors
Hardware

Material

Painted Steel
PVC / Stainless Steel
Polycarbonate / Stainless Steel
Aluminum
Painted Steel
Aluminum
Aluminum
PVC
Steel
Various Steel / Copper
Lead Free Electronic
PVC Coated Copper
Various Steel, Electronic
Nylon
Stainless Steel and Steel

 **Note:** Material type can be verified with use of a magnet with stainless and aluminum being non-magnetic.

REV	ECO	DESCRIPTION	DATE	DFTM	CHKD
A	13710	RELEASED TO PRODUCTION	5/8/2018	LS	BP

Parts List	
ITEM	DESCRIPTION
1	FOAM PREFILTER, 16 X 20 BLACK, 15 PPI
2	HEPA FILTER, ALUM FRAME, BEAD PACK, 99.99% EFFICIENCY
3	ASSY, SCREW W/CAPTIVE O-RING
4	FRONT ACCESS PANEL 6 FT.
5	FLUSH MOUNT FRONT PANEL 6 FT.
6	SPRING DIE 1/2"X1" MED HEAVY DUTY
7	SCR PPHMS 8-32 X 2" SS MIL 51957
8	.250 X .500 10-24 THD SHOULDER BOLT
9	#8 SST FLAT WASHER

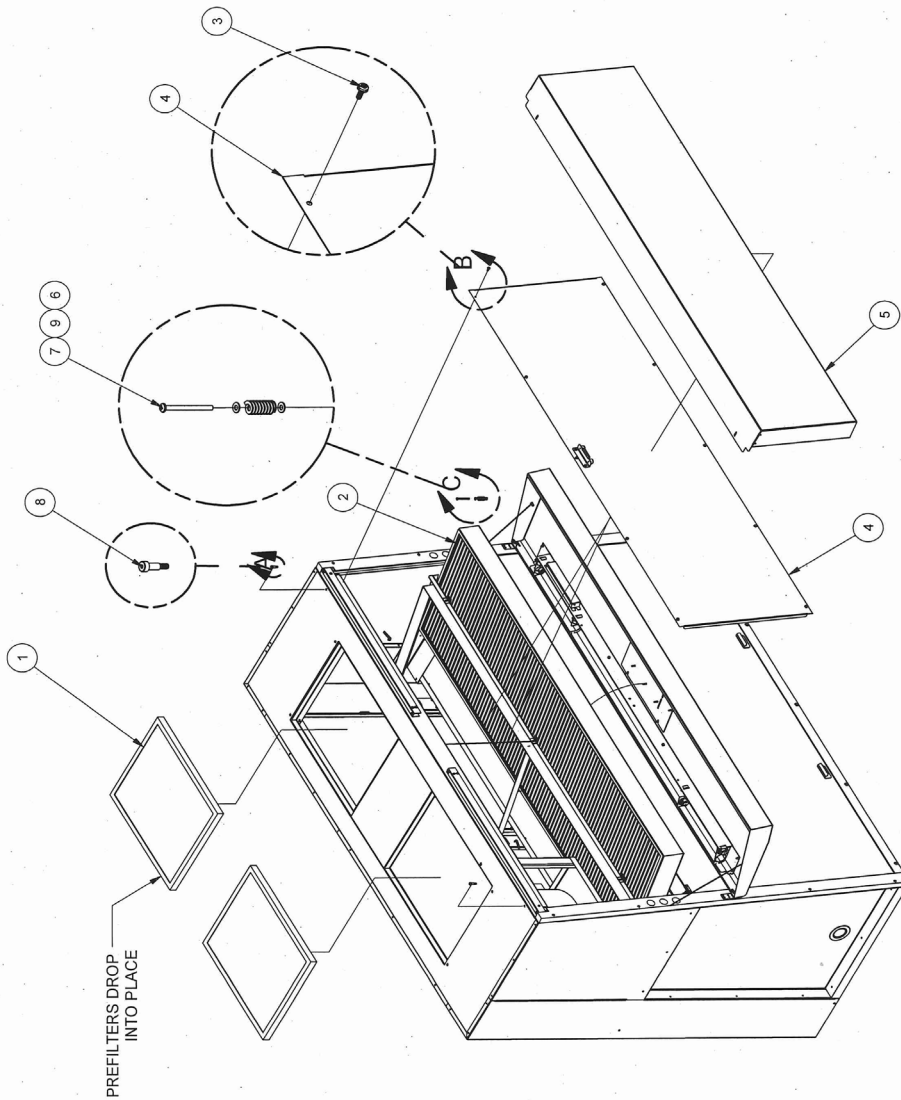

- HEPA FILTER REPLACEMENT PROCEDURE**
1. DISCONNECT UNIT POWER.
 2. CLOSE THE WINDOW TO FULLY CLOSED POSITION.
 3. REMOVE FLUSH MOUNT FRONT PANEL BY REMOVING (2) .250 X .500 10-24 SHOULDER BOLTS (1 EA. SIDE TOP).
 4. LOWER CONTROL BOX.
 5. REMOVE FRONT PRESSURE PANEL BY REMOVING 8-32 SCREWS ALONG TOP AN BOTTOM OF PANEL.
 6. REMOVE THE FRONT SCREW AND TENSION SPRING ASSEMBLIES ACROSS THE FRONT OF THE PLENUM (3 PLACES).
 7. TIP THE PLENUM UP AND HANG FROM HOOK LOCATED CENTER OF TOP HEADER ON THE TOP PANEL.
 8. LIFT FRONT OF HEPA FILTER AND REMOVE.
 9. REVERSE PROCEDURE FOR INSTALLATION AND OPERATION.
 10. RECONNECT UNIT POWER.

ORIGINAL

TITLE NU-140 VERTICAL AIRFLOW HEPA FILTER REPLACEMENT INSTRUCTIONS

DFTM	DATE	CHKD	SHEET	1	OF	1
LS	5/8/2018	BP				

DRAWING NUMBER **BCD-19998**

A

REV	ECO	DESCRIPTION	DATE	DFTM	CHKD
A	13826	RELEASED TO PRODUCTION	9/12/2018	TH	BP

ITEM	QTY	PART NUMBER	DESCRIPTION
1	2	X-980610-01	SCR PPH #12 X 3/4 A NKL
2	2	X-980794-02	1/4 SST FLAT WASHER
54	1	A-301-732	DIFFUSER HANDLE
55	2	X-980682-03	RIVET 5/32 DIA x .188 ALUM

REV	ECO	DESCRIPTION	DATE	DFTM	CHKD
A	13826	RELEASED TO PRODUCTION	9/12/2018	TH	BP

REV	ECO	DESCRIPTION	DATE	DFTM	CHKD
A	13826	RELEASED TO PRODUCTION	9/12/2018	TH	BP

2/18

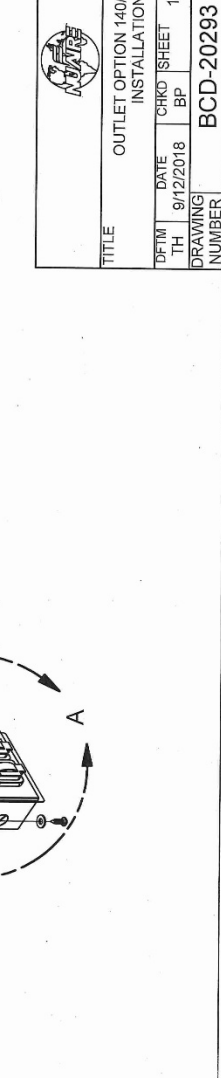
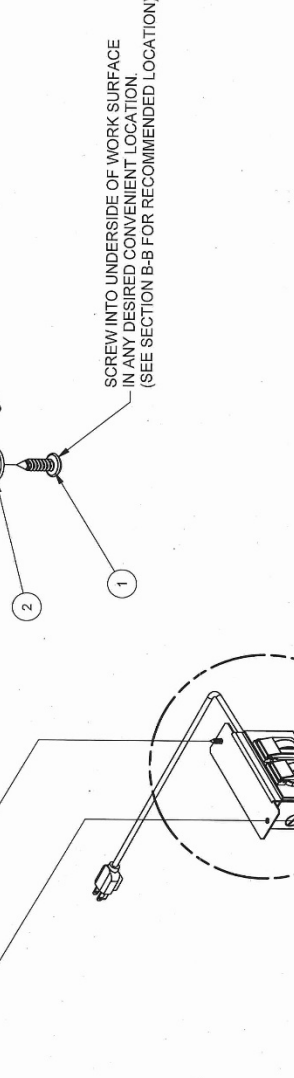
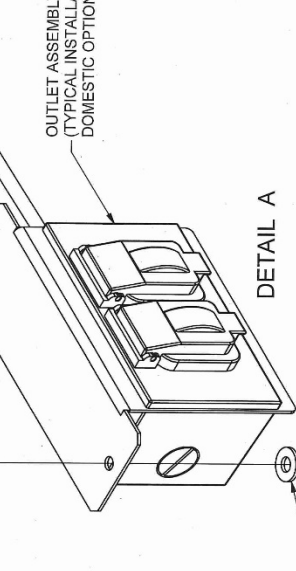
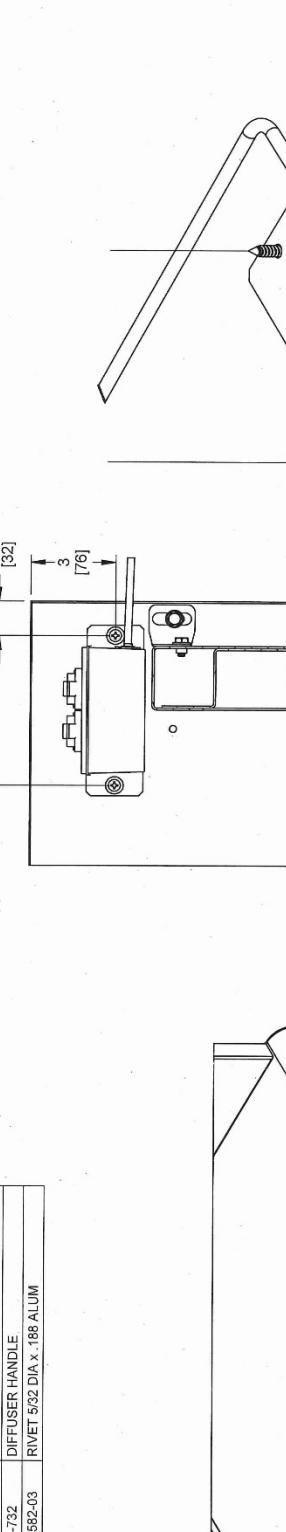

		ORIGINAL
TITLE OUTLET OPTION 140/240/340 INSTALLATION		
DFTM	DATE	CHKD
TH	9/12/2018	BP
DRAWING NUMBER		BCD-20293
		A

REV	ECO	DESCRIPTION	DATE	INL	INL
B		13810 UPDATED FOR PRODUCT RELEASE	7/24/2018	LS	BP

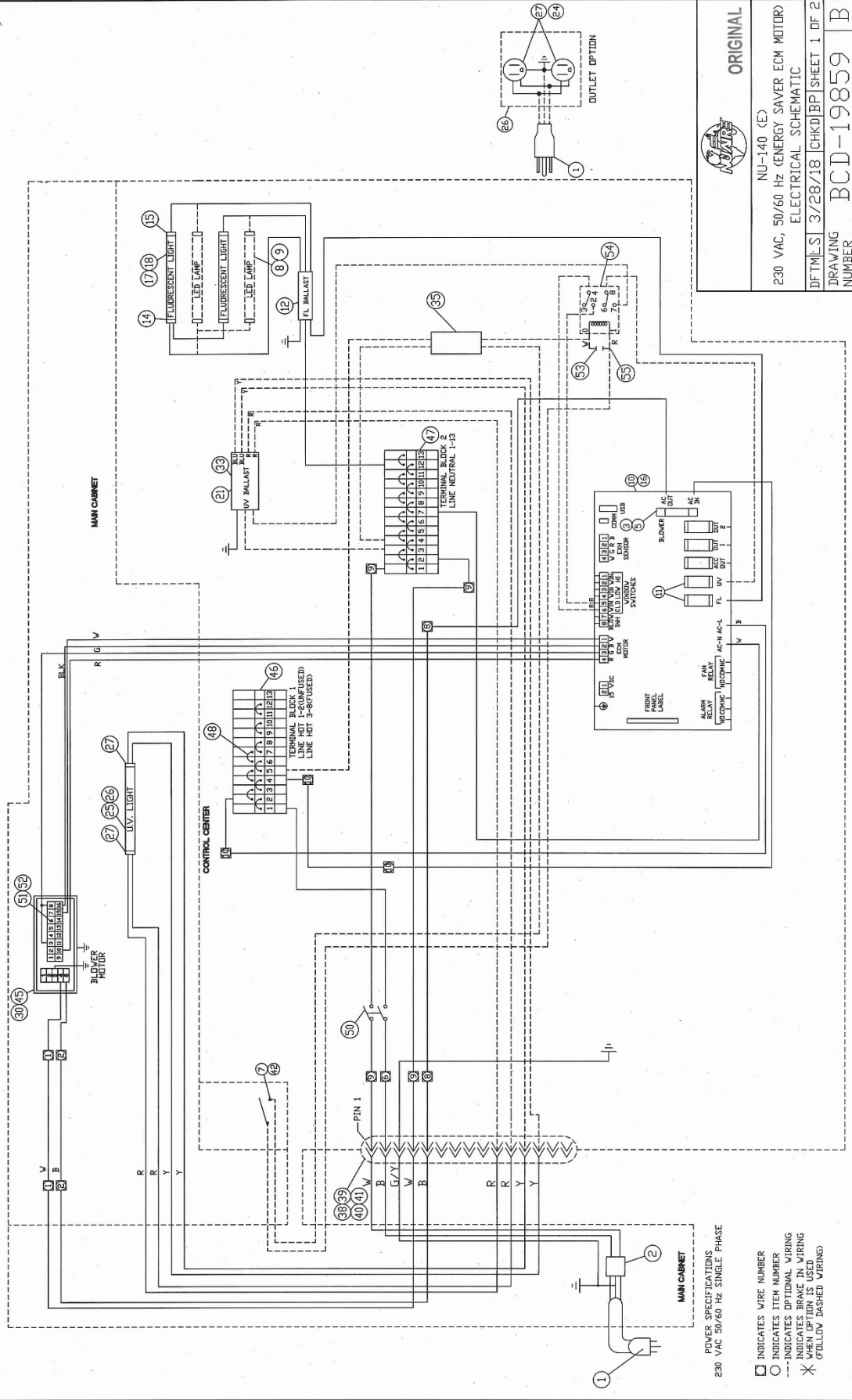

ORIGINAL
 NU-140 (E)
 230 VAC, 50/60 Hz (ENERGY SAVER ECM MOTOR)
 ELECTRICAL SCHEMATIC
 DFTM/LS 3/28/18 (CHKD) BPI SHEET 1 OF 2
 DRAWING NUMBER BCD-19859 B

ITEM QTY	DESCRIPTION	NUAIRE P/N	REV	ECD	DESCRIPTION	DATE	INL	INL
1	1/2 USA POWER CORD 18 FT. MOLDED PLUG	X-999543-02						
2	EMI FILTER	X-999319-03						
3	FUSE (5 A) (1/4X1-1/4) (MOTOR, 3 FT.)	X-999311-01						
4								
5	FUSE (6.25 AXI/4X1-1/4)(MOTOR, 4, 5 & 6 FT.)	X-999311V-06						
6								
7	ASSY SWITCH (ND (3 & 4FT.)	X-999690-03						
8	A/R LED LAMP (3 FT.)	X-999083-03						
9	A/R LED LAMP (4, 5, & 6 FT.)	X-999083-04						
10	ASSY. GAF III (BASIC) (3 FT.)	F-140-3262						
11	FUSE (1 AMP) (5 X 20mm) (LIGHTS)	X-999039-13						
12	BALLAST FLUORESCENT	X-999184-05						
13								
14	LAMPHOLDER FIXED BASE BI-PIN	X-999418-02						
15	LAMPHOLDER SPRING BASE BI-PIN	X-999418-01						
16	ASSY. GAF III (BASIC) (4, 5 & 6 FT.)	F-140-3263						
17	LAMP FLUORESCENT (4, 5 & 6 FT.)	X-999428-03						
18	LAMP FLUORESCENT (3 FT.)	X-999428-01						
19	BULKHEAD CONNECTOR 4 PIN	A-425-3654-03						
20								
21	BALLAST UV LAMP (3 FT.)	X-999184-09						
22	A/R OUTLET							
23								
24								
25	UV LAMP (4, 5 & 6 FT.)	X-999442-01						
26	UV LAMP (3 FT.)	X-999442-01						
27	UV SOLID BASE	X-999163-02						
28	BULKHEAD CONNECTOR 6 PIN	A-425-3654-01						
29								
30	MOTOR DC, ECM 5.0, 1/3 HP (3 FT.)	A-999931-11						
31								
32								
33	BALLAST, UV LAMP (4, 5 & 6 FT.)	X-999184-10						
34								
35	POWER SUPPLY 12 VDC	X-999836-06						
36								
37								
38	A/R SOCKET CONTACT	X-9998244-02						
39	A/R PIN CONTACT	X-9998244-01						
40	CONNECTOR PLUG 15 PIN	X-999285						
41	CONNECTOR RECEPTACLE 15 PIN	X-999286						
42	ASSY SWITCH (ND (5 & 6FT.)	A-140-3326						
43								
44	MOTOR DC, ECM 5.0, 1/2 HP (4, 5 & 6 FT.)	A-999931-05						
45	TERMINAL BLOCK ASSY CONTAINING: END-40 PLACE, TERMINAL BLOCK END, 4 PLACE, TERMINAL BLOCK TERMINAL BLOCK 2 PLACE NON-END TERMINAL BLOCK 4 PLACE NON-END	A-425-4099-01 X-999921-01 X-999921-03 X-999919-01 X-999919-02						
46	TERMINAL BLOCK ASSY CONTAINING: END-40 PLACE, TERMINAL BLOCK END, 4 PLACE, TERMINAL BLOCK TERMINAL BLOCK 2 PLACE NON-END TERMINAL BLOCK 4 PLACE NON-END	A-425-4099-02 X-999921-01 X-999921-03 X-999919-01 X-999919-02						
47	TERMINAL BLOCK ASSY CONTAINING: END-40 PLACE, TERMINAL BLOCK END, 4 PLACE, TERMINAL BLOCK TERMINAL BLOCK 2 PLACE NON-END TERMINAL BLOCK 4 PLACE NON-END	A-425-4099-02 X-999921-01 X-999921-03 X-999919-01 X-999919-02						
48	JUMPER, TERMINAL BLOCK	X-999920-01						
49	3	X-999920-01						
50	1 SWITCH (DPST)	X-999676-04						
51	CONNECTOR - HOUSING	X-999046-03						
52	CONNECTOR - SOCKET	X-999862-03						
53	1 CAPACITOR .22 MF	X-999132-30						
54	1 RELAY (DPDT)	X-999866-04						
55	2 DOUBLE SPADE CONNECTOR	X-999928-02						

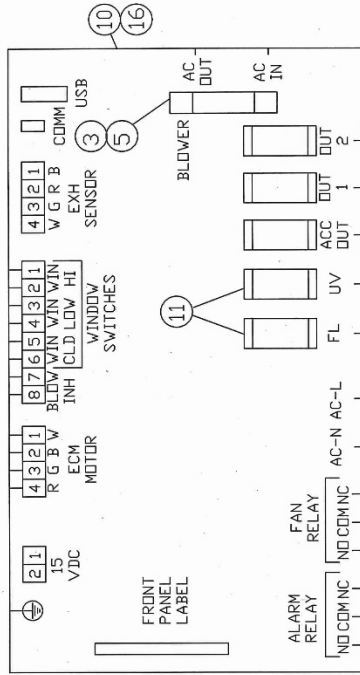

ORIGINAL

NU-140 (E)
230 VAC, 50/60 Hz (ENERGY SAVER ECM MOTOR)
ELECTRICAL SCHEMATIC

DFTM L S 3/28/18 CHKD BPI SHEET 2 OF 2
DRAWING NUMBER **BCD-19859** B