

LabGard® ES Energy Saver  
Class II, Type A2 Laminar Flow  
Biosafety Cabinet

Models  
NU-543-300/400/500/600  
Bench/Console

Operation and Maintenance Manual

January, 2022  
Revision 2  
Nu-543-300/400/500/600



Manufactured By:  
NuAire, Inc.  
2100 Fernbrook Lane  
Plymouth, MN 55447  
Toll-Free: 1-800-328-3352  
In Minnesota: (763)-553-1270  
Fax: (763)-553-0459

## Congratulations!

You have just purchased one of the finest Laminar Flow Biosafety Cabinets available. With proper care, maintenance (certification), and laboratory procedure, this cabinet will give you years of product and personnel protection from particulate contaminants as prescribed in NSF/ANSI 49. Please read this manual carefully to familiarize yourself with proper installation, maintenance and operation of the cabinet. Other reference and guideline materials are available through the following web sites;

[www.hc-sc.gc.ca](http://www.hc-sc.gc.ca)  
[www.cdc.gov/od/ohs/](http://www.cdc.gov/od/ohs/)  
[www.absa.org](http://www.absa.org)  
[www.cabs-acsb.ca](http://www.cabs-acsb.ca)  
[www.ebsaweb.eu](http://www.ebsaweb.eu)  
[www.inspection.gc.ca](http://www.inspection.gc.ca)  
[www.who.int](http://www.who.int)  
[www.biosafety.be](http://www.biosafety.be)  
[www.hse.gov.uk](http://www.hse.gov.uk)  
[www.nsf.org](http://www.nsf.org)  
[www.cetainternational.org](http://www.cetainternational.org)  
[www.nuaire.com](http://www.nuaire.com)

## About this Operation and Maintenance Manual

The information contained in this manual is intended to reflect our current production model along with the more frequently purchased options. Any unique additions, modifications, or shop drawings are appended in the back flap of this manual, along with any modifications and/or additions to procedures as outlined in this manual. A copy of the original factory test report is also appended to this manual. In case this manual and/or test report is lost or misplaced, NuAire retains a copy in our files. A replacement copy can be obtained by calling or writing NuAire, Inc. stating the model number and serial number and a brief description of the information desired.

**LabGard® ES Energy Saver Class II, Type A2 Laminar Flow Biosafety Cabinet  
Models NU-543-300/400/500/600 Operation and Maintenance Manual**

**Table of Contents**

Section No. 1 ..... General Information  
Section No. 2 ..... Models and Features  
Section No. 3 ..... Warranty  
Section No. 4 ..... Shipments  
Section No. 5 ..... Installation Instructions  
    5.1 ..... Location  
    5.2 ..... Set-up Instructions  
    5.3 ..... Testing Methods and Equipment  
Section No. 6 ..... Operating the NU-543  
    6.1 ..... FlowGard™ Control System  
    6.2 ..... Operating Guidelines  
    6.3 ..... Operating Sequence  
    6.4 ..... Ergonomics  
    6.5 ..... Cleaning Procedures  
    6.6 ..... Hazardous Drug Contamination Procedures  
Section No. 7 ..... General Maintenance  
    7.1 ..... Decontamination  
    7.2 ..... Fluorescent Lamp Bulb Replacement  
    7.3 ..... HEPA Filter/Motor Replacement  
    7.4 ..... Sliding Window Replacement and Manual Adjustment  
    7.5 ..... Airflow Control System Setup and Calibration  
    7.6 ..... HEPA Filter Leak test  
    7.7 ..... Airflow Smoke Pattern Test  
    7.8 ..... Site Installation Assessments  
    7.9 ..... Cleanliness Classification Test for Pharmacy Application  
    7.10 ..... Main Control Board Description and Replacement  
    7.11 ..... Digital Airflow Sensor Description and Replacement  
Section No. 8 ..... Error Messages, Troubleshooting and Option-Diagnostics  
Section No. 9 ..... Remote Contacts  
Section No. 10 ..... Optional Equipment  
    10.1 ..... Ultraviolet Light  
Section No. 11 ..... Electrical/Environmental Requirements  
Section No. 12 ..... Disposal and Recycle

**Manual Drawings**

ACD-16371 ..... NU-543 Airflow Schematic  
BCD-16372 ..... NU-543-300 Specification Drawing  
BCD-16373 ..... NU-543-400 Specification Drawing  
BCD-16374 ..... NU-543-500 Specification Drawing  
BCD-16375 ..... NU-543-600 Specification Drawing  
BCD-16300 ..... Drain Valve Installation  
BCD-16377 ..... Front Label  
BCD-16509 ..... NU-500 Series Auto Decontamination Set-Up

**Assembly Drawings**

BCD-16633 ..... Base Stand Assembly  
BCD-16301 ..... Control Center and Front Decorative Panel Assembly  
BCD-16376 ..... Sliding Window Assembly and Adjustment  
BCD-16299 ..... Base Cabinet Assembly

**Electrical Schematics**

CD-000111 (sheet 1 and 2)..... NU-543-300/400/500/600 Electrical Schematic

LabGard® ES Energy Saver  
Class II, Type A2 Laminar Flow  
Biosafety Cabinet  
Models  
NU-543-300/400/500/600  
Manufactured by:  
NuAire, Inc. - Plymouth, Minnesota, U.S.A.

## 1.0 General Information

### 1.1 Description

The LabGard® ES Model NU-543 Laminar Flow Biosafety Cabinet (LFBSC) is a bench/table top model, optionally available with a base support stand, for operation as a console model. The LabGard® ES model NU-543 utilizes an Energy Saver DC ECM motor optimally determined forward curved fan for each model size/width to maximize both energy efficiency and filter loading capacity. The Energy Saver ECM motor is controlled to airflow setpoints by the FlowGard™ control system via an integrated solid-state DC motor controller based on feedback algorithm to provide automatic compensation (constant volume control) for both filter loading and line voltage variances. Airflow velocity is monitored with the Intelliflow digital dual thermistor airflow sensor.

The Laminar Flow Biosafety Cabinet, (LFBSC) is a product resulting from the development of the "laminar flow" principle (see Airflow Schematic) and the application of environmental controls as required in the field of biological research or chemical containment. The LFBSC, when used with proper technique, is an effective primary engineering control in obtaining the optimum product quality while reducing the potential for exposure of both product and personnel to airborne biological or particulate chemical agents in low to moderate risk-hazard research and drug preparation or product operations, as prescribed by the Center for Disease Control (CDC) Atlanta, Georgia.

The NU-543 bench LFBSC meets the requirements of a Class II, since the cabinet conforms to the following requirements:

1. Maintains a minimum inflow velocity of 100 LFPM (.51mps) through the work access opening.
2. Has HEPA filtered downflow air that is mixed with the inflow air from a common exhaust plenum.
3. Discharges a percentage of air to the outside atmosphere after HEPA filtration.
4. Has all biologically contaminated ducts and plenums under negative pressure or surrounded by negative pressure.

If working with volatile chemicals, the cabinet must be connected to an external exhaust system with a canopy transition. Type A2 cabinets may be used for work with volatile chemicals if permitted by a chemical risk assessment.

## 1.2 Safety Instructions

These safety instructions describe the safety features of the LabGard® ES Model NU-543 LFBSC.

The safety cabinet has been manufactured using the latest technological developments and has been thoroughly tested before delivery. However, the cabinet may present potential hazards if it is not installed and used as instructed for its intended purpose or is used outside of operating parameters. Therefore, the following procedures must always be observed:

- The safety cabinet must be operated only by trained and authorized personnel.
- For any operation of this cabinet, the operator must prepare clear and concise written instructions for operating and cleaning, utilizing applicable safety data sheets, plant hygiene guidelines, and technical regulations, in particular.
  - Which decontamination measures are to be applied for the cabinet and accessories
  - Which protective measures apply while specific agents are used
  - Which measures are to be taken in the case of an accident
- Repairs to the device must be carried out only by trained and authorized expert personnel.
- Keep these operating instructions close to the cabinet so that safety instructions and important information are always accessible.
- Should you encounter problems that are not detailed adequately in the operating instructions, please contact your NuAire Representative of NuAire technical Services.

## 1.3 Explanation of Symbols



Safety alert symbol indicates a potentially hazardous situation which, if not avoided, could result in death of serious injury.

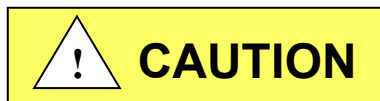

Safety alert symbol indicates a potentially hazardous situation which, if not avoided, may result in minor or moderate injury.

CAUTION

CAUTION used without the safety alert symbol indicates a potentially hazardous situation which, if not avoided, may result in property damage.



Potential electrical hazard, only qualified person to access.

 **Note:** Used for important information.



Biohazard



Flammable Hazard



Ground, Earth



Lead Free



Hazardous Gases! Personal Protection Equipment Required.



Chemical Hazard

REV	ECO	DESCRIPTION	DATE	DRFT	CHKD
A	12149	RELEASED TO PRODUCTION	10/15/13	LS	BP

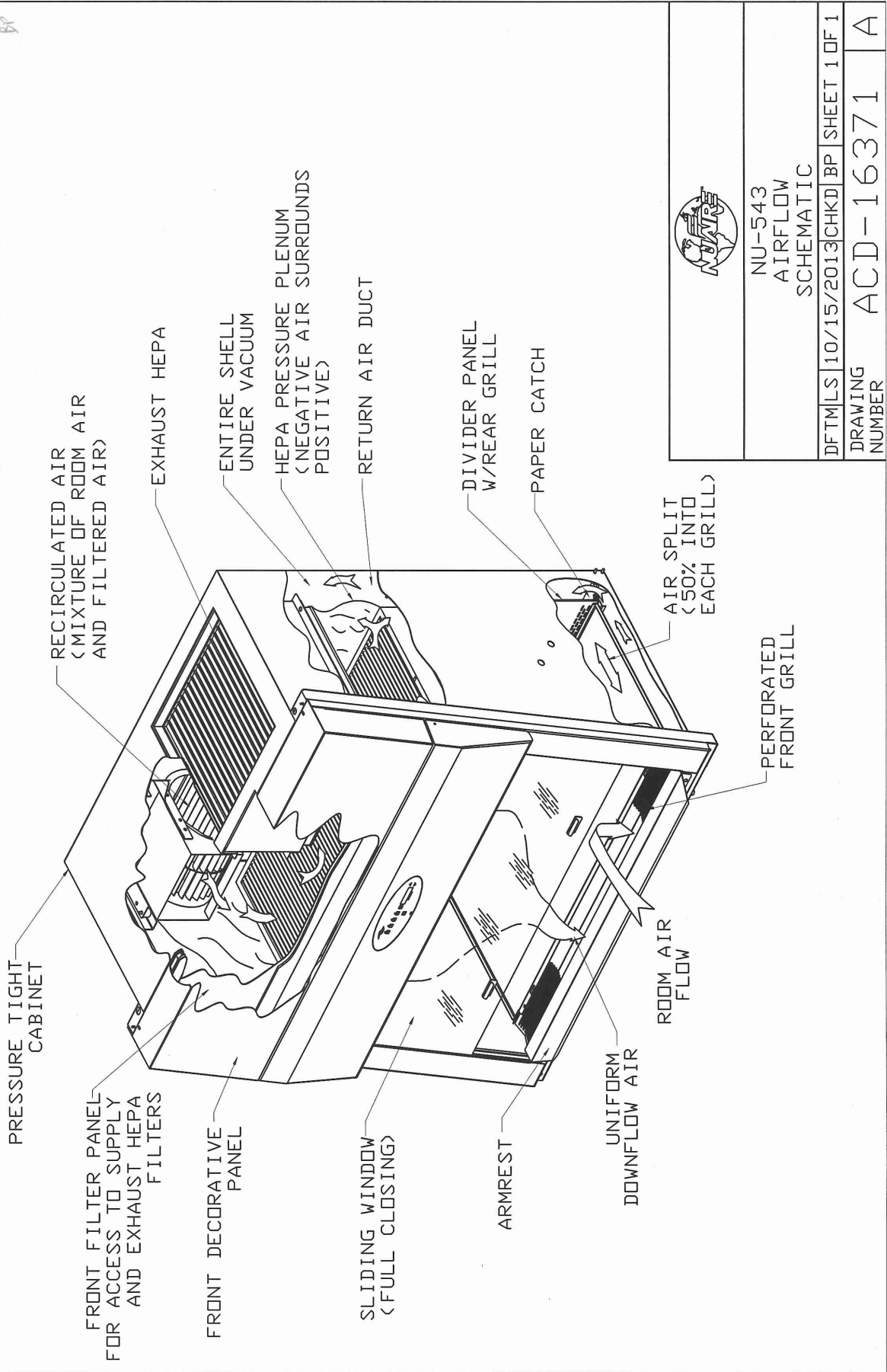

NU-543  
AIRFLOW  
SCHEMATIC

DFTM	LS	10/15/2013	CHKD	BP	SHEET 1	OF 1
DRAWING NUMBER				ACD-16371		
				A		

## **2.0 Models and Features**

The model NU-543, LabGard® ES, Class II, Type A2 Laminar Flow Biosafety Cabinet is manufactured in four sizes: 3 ft. (.9m), 4 ft. (1.2m) , 5 ft. (1.5m) , and 6 ft. (1.8m).



REV	CO	DESCRIPTION	DATE	DFTM	CHKD
F	000631	UPDATED W/ STANDARD PROP-UP WORKTRAY AND LED LIGHTING	2/22/2021	TH	DSH

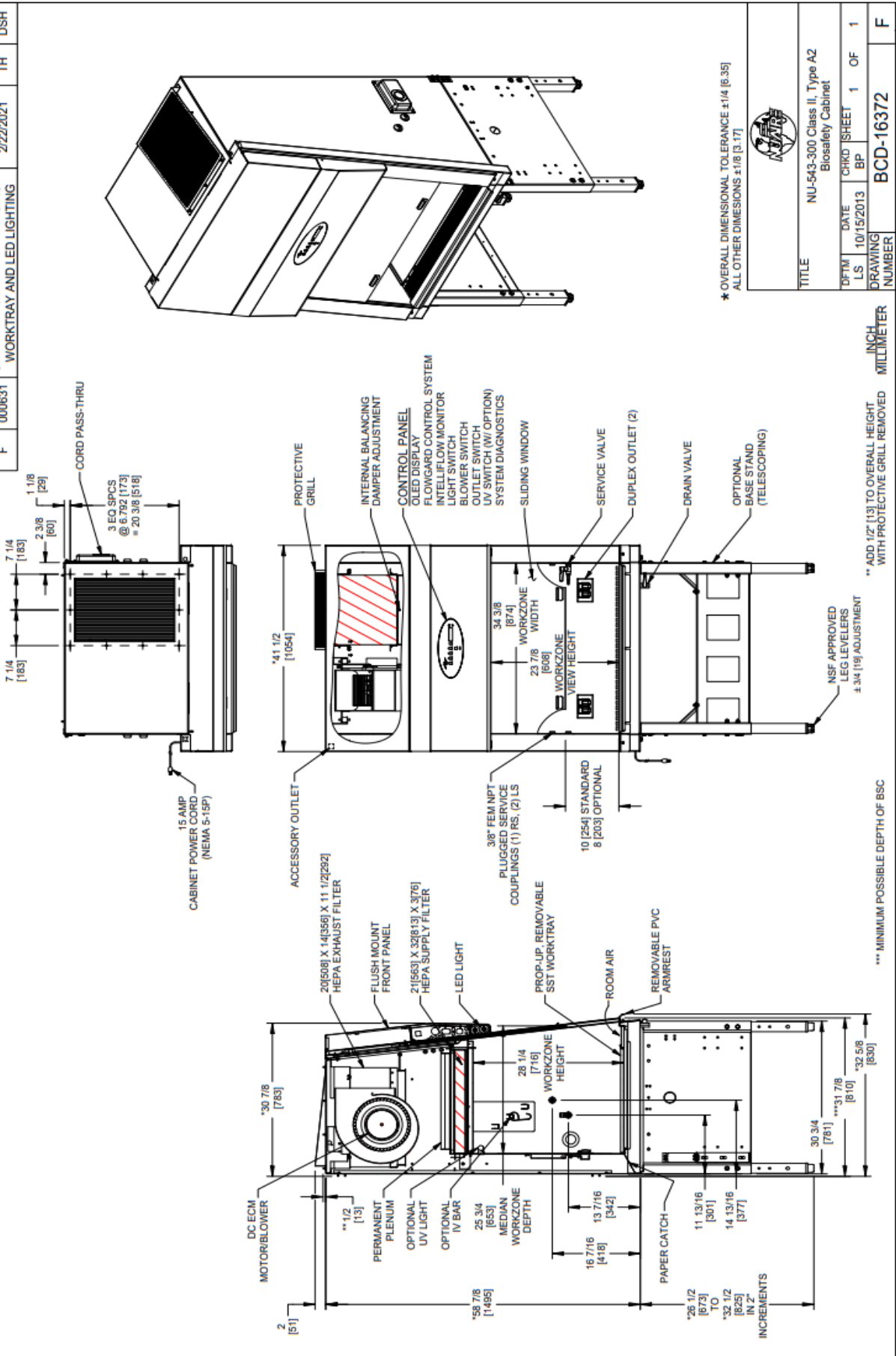

TITLE		NU-543-300 Class II, Type A2 Biosafety Cabinet	
DFTM	DATE	CHKD	ISHEET
LS	10/15/2013	BP	1 OF 1
DRAWING NUMBER		BCD-16372	





REV	CO	DESCRIPTION	DATE	DFTM	CHKD
E	000631	UPDATED W/ STANDARD PROP-UP WORKTRAY AND LED LIGHTING	2/22/2021	TH	DSH

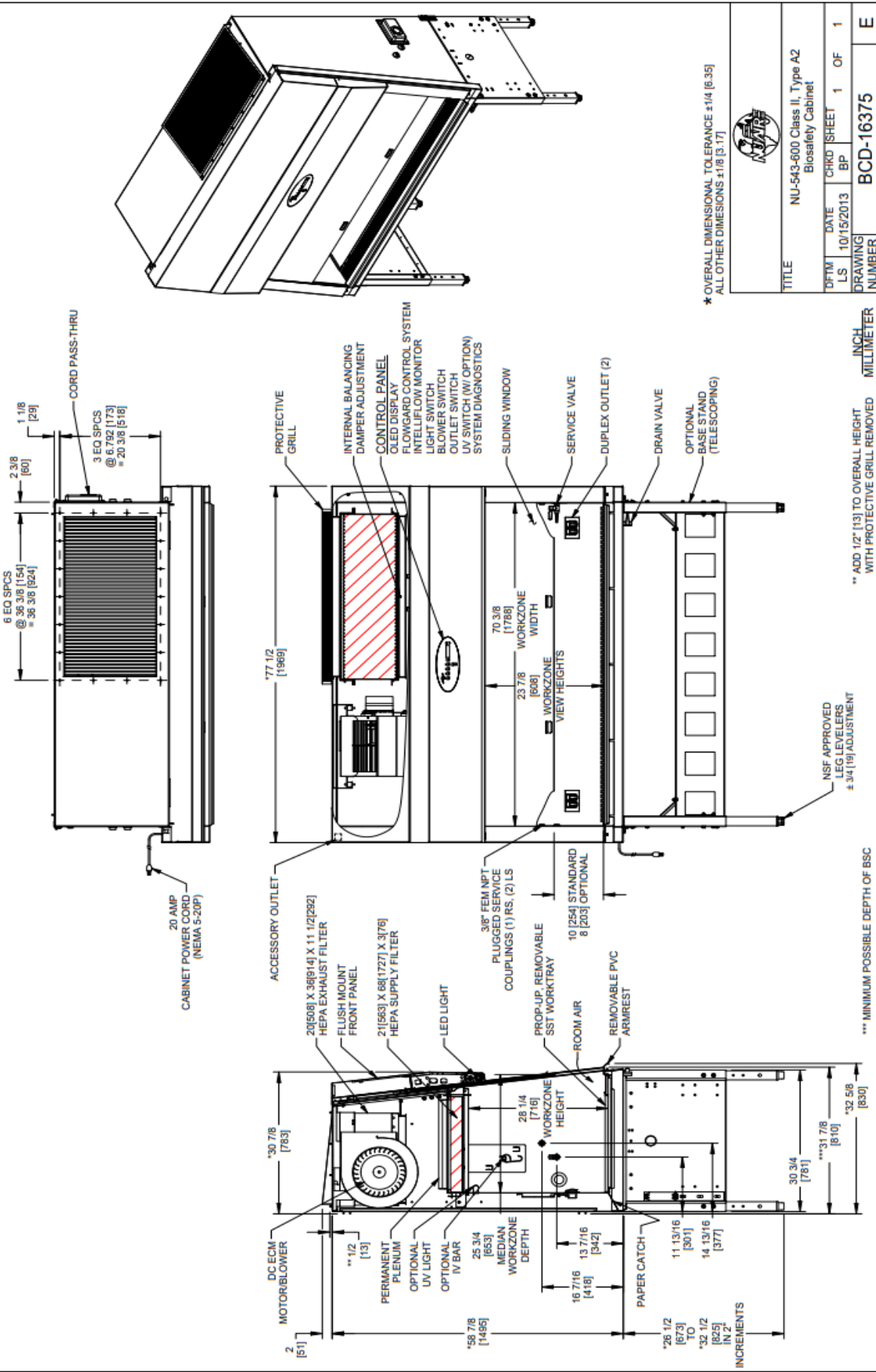

\* OVERALL DIMENSIONAL TOLERANCE ±1/4 [6.35]  
ALL OTHER DIMENSIONS ±1/8 [3.17]



TITLE		NU-543-600 Class II, Type A2 Biosafety Cabinet	
DFTM LS	DATE	CHKD	ISHEET
	10/15/2013	BP	1 OF 1
DRAWING NUMBER	BCD-16375		
			E

### **3.0 Warranty**

Details regarding product warranties can be found in the published warranty data separate from this manual and included within the data packet sent with the unit.

### **4.0 Shipments**

NuAire takes every reasonable precaution to assure that your LabGard® ES cabinet arrives without damage. Motor carriers are carefully selected and shipping cartons have been specially designed to insure your purchase. However, damage can occur in any shipment and the following outlines the steps you should take on receipt of a NuAire LabGard® ES cabinet to be sure that if damage has occurred, the proper claims and actions are taken immediately.

#### **4.1 Damaged Shipments**

- 4.1.1** Terms are factory, unless stated otherwise. Therefore, it is important to check each shipment before acceptance.
- 4.1.2** If there is visible damage, the material can be accepted after the driver makes a notation on the consignee's copy of the freight bill. Then an inspection must be made to verify the claim against the carrier. This inspection is the basis of your filing the claim against the carrier.
- 4.1.3** If concealed damage is found, it is absolutely necessary to NOTIFY THE FREIGHT AGENT AT ONCE, and request an inspection. Without this inspection, the transportation company may not accept a claim for loss or damage. If the carrier will not perform the inspection, an affidavit must be prepared stating that he was contacted on a certain date and that he failed to comply with the request. This along with other papers in the customer's possession will support the claim.

## 5.0 Installation Instructions

### 5.1 Location

Within the laboratory, pharmacy, etc., the ideal location of the Biosafety cabinet is away from personnel traffic lanes, air vents (in or out), doors and/or any other source of disruptive air currents.

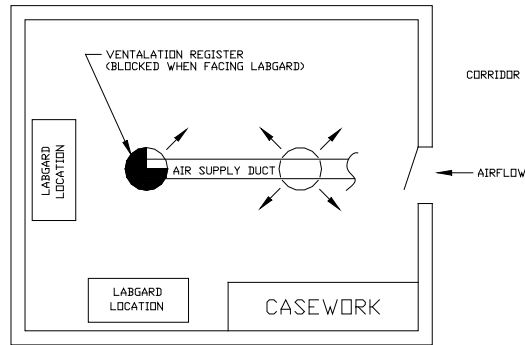

Suggested Cabinet Location in Laboratory

THE EXHAUST FILTER AREA IS ESPECIALLY SUSCEPTIBLE TO DISRUPTIVE AIR CURRENTS FROM AIR VENTS. The exhaust sensor for the Electronic Airflow Control System is located just above the exhaust HEPA filter and if disruptive air currents are present, the exhaust sensor could be influenced by them, and indicate disruptive readings on the front panel display.

If drafts or other disruptive air currents exceed the inflow velocity of the cabinet through the access opening, the potential exists for contaminated air to exit or enter the work zone area of the cabinet. It depends on the severity of the air current. REMEMBER: A BIOSAFETY CABINET IS NO SUBSTITUTE FOR GOOD LABORATORY TECHNIQUE.

Where space permits, a clear 6" (152mm) area should be permitted on each side of the cabinet for maintenance purposes. The electrical outlet into which the cabinet is connected should be readily accessible for maintenance purposes. **Do not position the cabinet to prevent access to the power cord.** The power cord plug serves as the disconnect and should remain readily accessible. If the outlet is inaccessible, such as a conduit (hardwired) connection, then an appropriate warning label should be applied near the cabinets on/off switch to indicate the circuit breaker on the power distribution panel should be used. A MINIMUM CLEARANCE OF 6" (152MM) IS REQUIRED FROM THE TOP OF THE CABINET TO THE CEILING FOR PROPER VENTILATION OF THE EXHAUST EFFLUX.

If this cabinet is used in a pharmacy application, it is strongly recommended (Per OSHA, NIOSH and ASHP) that the cabinet be exhausted to the outside. In addition, if this cabinet is used in microbiological application with minute quantities of volatile toxic chemicals and trace amounts of radionuclides, per CDC/NIH and NSF, it is strongly recommended that the cabinet be exhausted to the outside. NuAire offers a canopy type of exhaust transition, which will capture the exhaust efflux from the cabinet.

Canopy, Thimble or Air Gap Exhaust Transitions (with and without integral fan)

 **Note:** The Exhaust System should be fitted with a backdraft damper to prevent reversing of airflow in the system.

NuAire only recommends a canopy or thimble transitions for exhausting applications. See separate instruction sheets for a discussion of exhaust transitions and installation requirements.

## 5.2 Set-Up Instructions

Remove outer shipping protection (carton or crating). The cabinet is fastened to the base skid and it is usually the best procedure to leave the skid in place until the cabinet is located in its approximate position to facilitate ease in handling. It can then be removed from the skid by removing the banding, bolts and screws holding the cabinet to the skid. It may be necessary to remove the control center in order to gain passage through a doorway. It can easily be removed by following the instructions on drawing BCD-16301.



It is recommended that no less than two people are present using a lifting system for placement of the cabinet onto the base stand. It is not recommended to manually lift the cabinet onto the base stand.

### 5.2.1 Base Stand Assembly

The base stand is typically shipped knocked down in a separate carton and is assembled per drawing BCD-16385. Once assembled; place the stand in approximate position (ready for cabinet placement onto the base stand). Now lift the cabinet on top of the base stand and bolt the base stand to the cabinet using two 3/8" - 16 x 3/4" bolts and washers provided for the front base stand tabs and two 1/4" acorn nuts for the rear weld studs. Place the cabinet in the desired location.

### 5.2.2 Leveling

Using a level placed on the work tray, first adjust the leg levelers end to end and then front to back. The NSF approved leg levelers provide a  $\pm 3/4"$  (20mm) adjustment.

### 5.2.3 Bench Installation (BCD-16300)

Place the cabinet on the bench with approximately a 2" (51mm) overhang clearance for installation of the drain valve. Place the cabinet in desired location and using RTV caulk, seal all around the base of the cabinet and the bench. This provides a tight seal to prevent bench spills from migrating under the cabinet.

If the drain valve is desired, (NOTE, CHECK WITH YOUR SAFETY PERSONNEL FOR REGULATORY REQUIREMENTS OF DRAIN VALVE INSTALLATION) remove the handle from the valve stem to gain clearance for valve body rotation. Add Loctite 242 (furnished) to the threads and rotate valve body until secure, with the valve stem (for handle) on the left side. Re-install handle to valve stem. Adjust the cabinet on bench to provide a 2" (51mm) overhang and seal the interface of the bench and cabinet, using RTV caulk as above.

### 5.2.4 Gas Service

NuAire doesn't recommend the use of natural gas within the LFBSC, but if gas service is determined to be necessary for the application, appropriate safety measures must take place. All NuAire LFBSC's have precautionary warning labels that say the following:

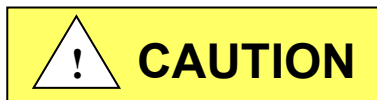

Use of explosive or flammable substances in this cabinet should be evaluated by your appropriate safety personnel.

Once the determination has been made by the appropriate safety personnel, the application of natural gas must be performed in accordance to national, state and local codes. IT IS ALSO STRONGLY RECOMMENDED THAT AN EMERGENCY GAS SHUTOFF VALVE BE PLACED JUST OUTSIDE THE LFBSC ON THE GAS SUPPLY LINE.

All NuAire's LFBSC's meet the safety requirements of UL and CSA for Laboratory Equipment. To comply with these safety requirements, NuAire uses only certified gas valves. If external piping is required, only black pipe is used for this application.

As previously stated NuAire doesn't recommend the use of natural gas within the LFBSC and ASSUMES NO RESPONSIBILITY FOR ITS USE. USE AT YOUR OWN RISK. The Bunsen burner flame within the LFBSC not only contributes to heat build-up; it also disrupts the laminar air stream, which must be maintained for maximum efficiency. IF THE PROCEDURE DEMANDS USE OF A FLAME, A BUNSEN BURNER WITH ON DEMAND IGNITION IS STRONGLY RECOMMENDED. DO NOT USE CONSTANT FLAME GAS BURNERS. During use, the Bunsen burner should be placed to the rear of the workspace where resulting air turbulence will have a minimal effect.



THE NUAIRE BIOLOGICAL SAFETY CABINET HAS A DRAIN PAN BELOW THE WORK TRAY DESIGNED TO SUBSTANTIALLY DRAIN SPILLS THAT ACCIDENTALLY OCCUR IN THE WORK ZONE. A 3/8" BALL DRAIN VALVE IS LOCATED ON THE FRONT OF THE CABINET FOR CONVENIENCE. THE CABINET BASE MEETS THE NSF OBJECTIVE WITH THE CAPABILITY OF BEING SEALED TO THE BENCH UPON WHICH IT RESTS.

FIGURE - 1

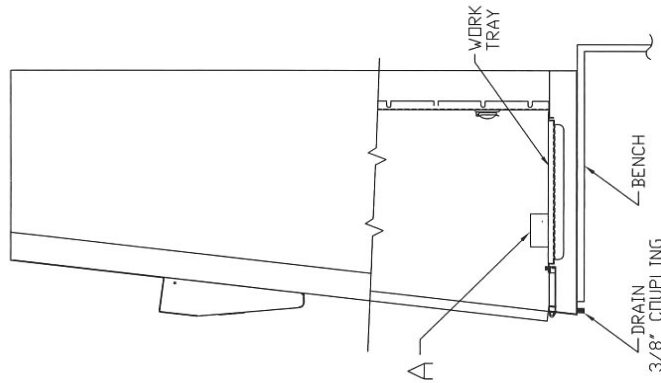

- 1.) PLACE THE CABINET ON A BENCH WITH APPROXIMATELY 2 (51mm) INCHES OVERHANG CLEARANCE FOR INSTALLATION OF DRAIN VALVE.
- 2.) REMOVE CARTON - A AND CONTENTS FROM WORK AREA, AND INSTALL THE DRAIN VALVE AS SHOWN IN FIGURE 2.

REV	ECO	DESCRIPTION	DATE	DRFT	CHKD
B	13327	ADDED NU-550/560/565	4/14/2017	TH	BP

FIGURE - 2

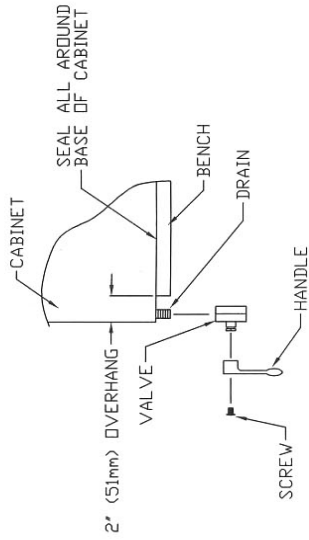

- 3.) REMOVE HANDLE FROM VALVE STEM TO GAIN CLEARANCE FOR VALVE BODY ROTATION FOR INSTALLATION OF DRAIN VALVE.
- 4.) ADD LOCTITE 242 FURNISHED TO THREADS AND ROTATE VALVE BODY UNTIL SECURE WITH VALVE STEM ON LEFT SIDE AS SHOWN.
- 5.) RE-INSTALL HANDLE TO VALVE STEM.
- 6.) ADJUST THE CABINET ON THE BENCH, WITH A 2" (51mm) OVERHANG AND SEAL INTERFACE WITH BENCH TOP, USING RTV SILICON SEALANT.

FIGURE - 3

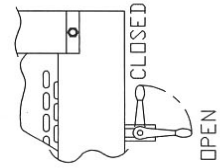

		<b>ORIGINAL</b>	
NU-540 / 543 / 545 / 550 / 560 / 565		DRAIN VALVE	
		INSTALLATION	
DFT/MLS	9/12/13	CHKD/BJ	SHEET 1 OF 1
DRAWING NUMBER	BCD-16300		B



### 5.2.5 Plumbing Services

Service ball valves with the type of service specified by the removable button on the handle are located in the work zone. The service ball valves are not recommended for pressure over 75 p.s.i. (5.2 BAR). Reducing valves should be installed external to the cabinet if necessary. Service ball valves should never be used for flammable gasses or oxygen service. A special needle valve for oxygen service or certified valve is required and available upon request.

External connection is to 3/8 inch NPT coupling in the inner sidewalls. Connection to plant utilities should be made with proper materials for the individual service and according to national and/or local codes. Observe all labels pertaining to the type of service and operating pressure.

### 5.2.6 Electrical Services

The NU-543 series Biosafety Cabinets may be "hardwired" (optional) or plugged into an outlet with protective earthing connection with the standard power cord. The cabinet requires 115 VAC, 60 Hz, single phase (current rating varies per cabinet size, reference Electrical/Environmental Requirements). It is recommended that power to the cabinet, whether hardwired or plug connected, be on its own branch circuit, protected with a circuit breaker at the distribution panel near the cabinet. **A surge protector is strongly recommended** if you are experiencing power related faults.

 **NOTE: THIS CABINET CONTAINS ELECTRONIC BALLASTS FOR THE FLUORSCENT LIGHTING. ELECTRONIC BALLASTS OPERATE WITH HIGH INRUSH CURRENT. IT IS NOT RECOMMENDED TO USE THIS PRODUCT WITH GROUND FAULT CIRCUIT INTERRUPTERS (GFCI'S) BECAUSE THE BALLASTS MAY CAUSE THE GFCI TO TRIP.**

### 5.2.7 Final Assembly

 **NOTE: Remove the protective cardboard cover over the exhaust HEPA filter.**

Remove the protective cardboard cover over the exhaust HEPA filter located under the protective screen if in place. The exterior surface and viewing glass are easily cleaned with any mild household detergent cleaner using a soft cloth. Harsh chemicals, solvent-type cleaners and abrasive cleaners should not be used.

Do not attempt to clean the HEPA filter media. Cabinet interior walls or work surface are easily cleaned with any mild household detergent cleaner using a soft cloth. Turn the cabinet on and let it operate for 60 minutes before using it as a LFBSC.

## 5.3 Testing Methods, Equipment and Preventative Maintenance

### 5.3.1 Testing Methods and Equipment

After installation and prior to use, NuAire recommends that the cabinet be tested or commissioned to factory standards. As part of testing, the certifier should go through the following initial checklist to assure all aspects of the LFBSC installation are complete and ready for testing.

- Review product installation
  - Exhaust connection, if present
  - Damper valve installed correctly with label toward front, if present
  - LFBSC base stand level
- Verify airflow sensor shroud is in place
  - Exhaust flow
  - Verify user menu language desired
- Verify configuration motor type and size selection for specific model
- Perform LFBSC certification
  - At a minimum, the following tests should be performed:
    - HEPA filter leak test
    - Downflow velocity test
    - Inflow velocity test
    - Airflow smoke patterns
    - Site installation assessment tests

The testing methods and equipment required are specified on the factory inspection report included with this manual (see insert in back cover).

 **NOTE: IT IS RECOMMENDED THAT THESE TESTS BE PERFORMED BY A QUALIFIED TECHNICIAN WHO IS FAMILIAR WITH THE METHODS AND PROCEDURES FOR TESTING BIOSAFETY CABINETS (SEE INSERT).**

 **NOTE: AFTER THE INITIAL CERTIFICATION, NUAIRE RECOMMENDS THAT THE CABINET BE RECERTIFIED AT A MINIMUM OF AN ANNUAL BASIS AND AFTER EVERY FILTER CHANGE, MAINTENANCE ACTION, OR ANY TIME THE OPERATOR FEELS IT IS NECESSARY.**

### 5.3.2 Preventative Maintenance

NSF/ANSI 49 Annex I.1.9 (formerly E.9) states “The current lifespan of a BSC is approximately 15 years.” However, how a Biosafety Cabinet (BSC) is used will impact its lifespan. Does the BSC run 24/7, daily or as needed? What type of facility or laboratory environment is it used in? What procedures or protocols are used within the BSC? What cleaning procedure and materials are used? These all have an impact on BSC lifespan.

Because of the wide variance of answers to the questions above, *NuAire recommends periodic Preventative Maintenance (PM) review of BSC mechanical, electrical and safety systems to assure maximum product performance.* Since BSC’s are certified at a minimum annually for critical performance per NSF/ANSI 49 Annex N.5 (formerly Annex F) and EN12469 Annex J, PM review can be accomplished during or as a part of the certification process. Just as the certification process monitors and reports HEPA filter loading/life, review of mechanical, electrical and safety systems can reduce the probability of part degradation before any breakdown or failure occurs.

- Preventative Maintenance Review

As with the certification process, the key to PM is to develop a record of critical parts and systems during the certification/PM review process. The PM review can start with safety systems or the site installation assessment tests as required per NSF/ANSI 49 Annex N.5.7 (formerly Annex F.7). The site installation assessment tests require the certifier to review and test the safety functions for sash, exhaust/interlock and airflow alarms. The record or reporting function for the site installation assessment tests are a required part of the certification report. The additional PM review record can be part of or an addition to the certification report.

To develop a record of the critical parts and systems, NuAire recommends the first PM review to be performed after 3 to 5 years of use, followed by every other year up to 12 years of use and every year after that. Being the stated lifespan of a BSC is approximately 15 years, an annual review of older BSC's is required to monitor part and system degradation to assure the critical nature of biological/chemical containment performance is maintained (reference NuAire Service Technical Bulletin STB0377 for further guidance).

**LabGard® ES Energy Saver Class II Type, A2 Laminar Flow Biosafety Cabinet  
Models NU-543-300/400/500/600**

Catalog Number	Catalog Number			
	NU-543-300 Nominal 3 foot (0.9m)	NU-543-400 Nominal 4 foot (1.2m)	NU-543-500 Nominal 5 foot (1.5m)	NU-543-600 Nominal 6 foot (1.8m)
Performance Specifications 1. Personal Protection 2. Product Protection	NSF/ANSI 49	NSF/ANSI 49	NSF/ANSI 49	NSF/ANSI 49
NSF/ANSI 49	Class II, Type A2	Class II, Type A2	Class II, Type A2	Class II, Type A2
Style of Cabinet	Bench top/console w/base stand/storage cabinet	Bench top/console w/base stand/storage cabinet	Bench top/console w/base stand/storage cabinet	Bench top/console w/base stand/storage cabinet
Cabinet Construction	All welded stainless steel 16/18GA, Type 304 pressure tight design	All welded stainless steel 16/18GA, Type 304 pressure tight design	All welded stainless steel 16/18GA, Type 304 pressure tight design	All welded stainless steel 16/18GA, Type 304 pressure tight design
Diffuser for Air Supply (Metal)	Non-flammable	Non-flammable	Non-flammable	Non-flammable
HEPA Filter Seal Type: Supply Filter-99.99% Eff. on 0.3 microns Exhaust Filter-99.99% Eff. on 0.3 microns	HEPEX Seal Neoprene, Spring-loaded	HEPEX Seal Neoprene, Spring-loaded	HEPEX Seal Neoprene, Spring-loaded	HEPEX Seal Neoprene, Spring-loaded
Fumigation : per NIH/NSF Procedures	Yes	Yes	Yes	Yes
Standard Services: Service Coupling (3/8 inch NPT) Service Coupling (3/8 inch NPT) Gas Valve/Service Coupling (3/8inch NPT) Duplex Outlet	One Right Sidewall Two Left Sidewall One Right Sidewall Two Backwall	One Right Sidewall Two Left Sidewall One Right Sidewall Two Backwall	One Right Sidewall Two Left Sidewall One Right Sidewall Two Backwall	One Right Sidewall Two Left Sidewall One Right Sidewall Two Backwall
Optional Services: Gas Cocks 3/8" NPT Ultraviolet Light Standard/Cup Sinks	Up to 3 ea. Sidewall One, Backwall Left or Right Work Surface	Up to 3 ea. Sidewall One, Backwall Left or Right Work Surface	Up to 3 ea. Sidewall One, Backwall Left or Right Work Surface	Up to 3 ea. Sidewall One, Backwall Left or Right Work Surface
Cabinet Size Inches (mm): Height (Fully Assembled) Height (Minimum for Transport) Width Depth with Armrest Removed	60 7/8 (1546) 59 (1499) 41 5/8 (1057) 31 7/16 (799)	60 7/8 (1546) 59 (1499) 53 5/8 (1362) 31 7/16 (799)	60 7/8 (1546) 59 (1499) 65 5/8 (1669) 31 7/16 (799)	60 7/8 (1546) 59 (1499) 77 5/8 (1972) 31 7/16 (799)
Work Access Opening Inches (mm): Standard Opening Height/Optional Standard Inflow Velocity	10 (254)/8(203) 105 FPM (.53 m/s)	10 (254)/8(203)/12(305) 105 FPM (.53 m/s)	10 (254)/8(203)/12(305) 105 FPM (.53 m/s)	10 (254)/8(203)/12(305) 105 FPM (.53 m/s)
Work Zone Inches (mm): Height Width Depth measured at 10 inches (254mm) window height	28 1/2 (724) 34 3/8 (873) 25 3/4 (654)	28 1/2 (724) 46 3/8 (1178) 25 3/4 (654)	28 1/2 (724) 58 3/8 (1483) 25 3/4 (654)	28 1/2 (724) 70 3/8 (1788) 25 3/4 (654)
Viewing Window Inches (mm): Standard is safety plate sliding glass	Fully closed to 21(533) open	Fully closed to 21(533) open	Fully closed to 21(533) open	Fully closed to 21(533) open
Required Exhaust CFM/CMH (opening) Standard/Optional: Canopy Variable Flow Thimble (NU-911)  Canopy Fixed Flow Thimble (NU-907)	10(254) /8(203) /12(305) CFM (CMH) 276-501 (649-851) 255-450 (383-765) 341-554 (576-933) 320 (544) 269 (457) 387 (650)	10(254) /8(203) /12(305) CFM (CMH) 363-588 (617-1000) 295-520 (502-884) 430-655 (731-1113) 426 (724) 359 (610) 483 (821)	10(254) /8(203) /12(305) CFM (CMH) 451-676 (766-1149) 365-590 (621-1003) 531-760 (909-1291) 531 (902) 445 (756) 610 (1036)	10(254) /8(203) /12(305) CFM (CMH) 538-763 (915-1297) 436-661 (741-1124) 634-865 (1088-1470) 634 (1077) 532 (904) 763 (1251)
Plant Duct Static Pressure Eng./Metric	0.05-0.1"/1.27-2.54mm H2O	0.05-0.1"/1.27-2.54mm H2O	0.05-0.1"/1.27-2.54mm H2O	0.05-0.1"/1.27-2.54mm H2O
Heat Rejected, BTU, Per Hour (opening) (non-vented) (vented)	10(254) /8(208) 903 / 826 120	10(254) /8(208) /12(305) 1140 / 1020 / 1256 157	10(254) /8(208) /12(305) 1768 / 1611 / 1884 198	10(254) /8(208) /12(305) 1884 / 1768 / 2041 198
Electrical: Volts, AC 60 Hz +Amps: Blower/Lights (10/8/12 openings) Amps: Duplex Rated Amps: 12 ft. Power Cord (one)	U.L./U.L.-C Listed 115 2.3/2.1 3 10 14 GA - 3 Wire, 15A	U.L./U.L.-C Listed 115 2.9/2.6/3.2 3 14 12 GA - 3 Wire, 20A	U.L./U.L.-C Listed 115 4.5/4.1/4.8 3 16 12 GA - 3 Wire, 20A	U.L./U.L.-C Listed 115 4.8/4.5/5.2 3 16 12 GA - 3 Wire, 20A
Crated Shipping Weight:*** Net Weight	460 lbs. /209 kg. 410 lbs. /186 kg.	530 lbs. /240 kg. 480 lbs. /218 kg.	620 lbs. /281 kg. 570 lbs. /258 kg.	690 lbs. /313 kg. 640 lbs. /290 kg.

\*\*\*Crated shipping weight does not include weight for accessories or options

+ Based on cabinet with new filters running at 115VAC.

## 6.0 Operating the NU-543

### 6.1 FlowGard™ Control System

#### 6.1.1 Overview

The FlowGard™ electronic control system is designed to service the control requirements of the LabGard® ES NU-543 Biosafety Cabinet. The control system consists of an electronic module that will perform the following functions:

- Easy user interface via OLED (Organic Light Emitting Diode) display/function keys\
- Language selectable user interface menu's (English, Spanish, German, French, Chinese, Japanese)
- Control blower via solid state switch.
- Control lights via solid state switch.
- Control outlets via solid state switch.
- Disable audible alarm switch with ring back function.
- Control blower DC ECM motor with solid-state DC Motor Controller that provides automatic compensation (constant volume control) for both filter loading and line voltage variances.
- Monitor and display airflow velocity performance via Intelliflow Monitor.
- Display time of day and temperature.

The LabGard® ES NU-543 offers the latest digital microprocessor design technology for improved cabinet performance and safety. The FlowGard™ control system integrates a dual thermistor airflow sensor (Intelliflow) to monitor the cabinet's airflow performance. The FlowGard™ control system also integrates a DC motor controller that provides automatic compensation for both filter loading and line voltage variances. There is additional on/off control of blower, fluorescent light, ultraviolet light (optional) and outlets. Lastly the control system monitors the sliding window position with micro switches. All the above functions are shown in a system block diagram (see figure 1).

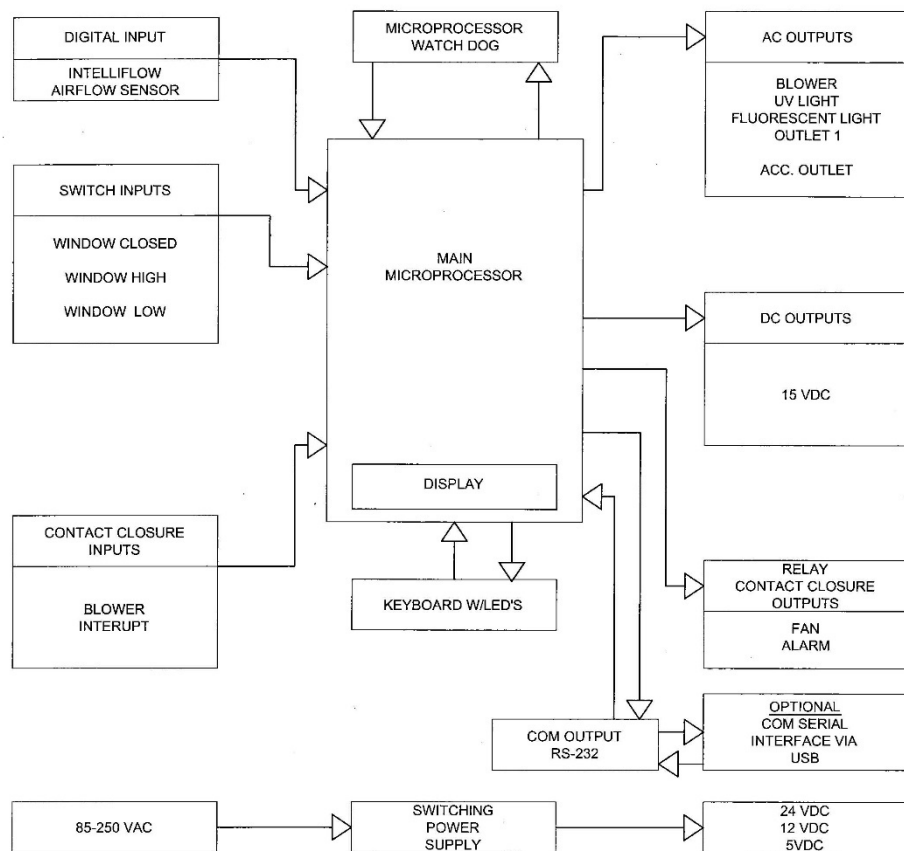

AEROMAX CONTROL SYSTEM BLOCK DIAGRAM

Figure 1

REV	ECO	DESCRIPTION	DATE	DFTM	CHKD
B	12377	UPDATED TO "FLOWGARD" DESIGN	5/15/2014	LS	BP



TITLE		ORIGINAL	
NU-543 FRONT LABEL			
DFTM	DATE	CHKD	SHEET
LS	5/15/2014	BP	1 OF 1
DRAWING NUMBER		BCD-16377	
			B

## 6.1.2 Front Panel

The control system front panel contains the following functions described in detail (see Drawing BCD-16377).

### 6.1.2.1 Blower Key

The blower key controls the ON/OFF power to the blower.

LED above key indicates: Full green for blower on

Blinking green for blower pending

Blinking full red for blower alarm

### 6.1.2.2 Hidden Key

The hidden key is located just above the blower LED indicator centered in the airflow symbol. The hidden key is used for various functions including the blower password 3 key sequence if the option is activated.

### 6.1.2.3 Fluorescent Light Key

The fluorescent light key controls the on/off power to the fluorescent light.

LED above the key indicates full blue for fluorescent light on, blinking blue during auto timer duration.

### 6.1.2.4 Ultraviolet (UV) Light Key

The UV light key controls the on/off power to the UV light (if optionally installed).

LED above indicates full yellow for UV light on, blinking yellow during auto timer duration.

### 6.1.2.5 Outlet Keys

The outlet key controls the ON/OFF power to the outlets.

LED above indicates full blue for outlets on, blinking blue during auto timer duration.

### 6.1.2.6 Red Alarm LED

The red alarm LED will indicate any alarm condition and remain indicating until the alarm condition is cleared.

A blinking red alarm LED indicates a power interruption has occurred.

### 6.1.2.7 Audible Alarm Silence Key

The audible alarm silence key allows user interaction to silence an audible alarm for a period of 15 minutes.

After 15 minutes if the alarm condition still exists, the audible alarm will again sound.

The audible alarm silence key also is used to exit all FlowGard™ user interaction menus.

### 6.1.2.8 Arrow Adjustment Keys

The arrow adjustment keys allow user interaction for various functions.

### 6.1.2.9 ENT Key

The ENT key is used to select item on display or accept and enter current item, function or value.

## 6.1.3 Control System Power

After the LabGard® ES NU-543 is plugged into the appropriate facility line power the control system will power up and display a power on reset message, the last revision of software (for several seconds) and time. The control panel will also indicate the power up status by blinking the red alarm LED. Pressing any key will acknowledge the power up status and turn off the blinking red alarm LED.

If a power interruption occurs, all control system functions, calibrations and parameters will be maintained and continue upon restoration of power. Just as the initial power up, the red alarm LED will blink to indicate power up status along with the display message of power on reset.

Airflow idle	XX:XX
GAF3 Version XX:XX	
Power on Reset	

### 6.1.4 Standby Mode

When the BSC is not in use, the display will indicate the NuAire logo with the current time provided in the upper right corner. Any of the function keys, except the blower that initiates run mode may be turned on and off in standby mode. The cabinet status and main menu may also be accessed for use as needed. The display for the FlowGard™ Control System has a screen saver built in for extended OLED life. The screen saver time is 5 minutes. This means after 5 minutes when the blower is not on, the display will go dark. Pressing any key will again illuminate the display.



### 6.1.5 Run Mode

Any time the blower run key is pressed with the sliding window at its correct operational height, the RUN MODE screen will appear. The Run Mode will start with a warm-up countdown from 3 minutes. During the warm up period the aseptic cleaning process may begin. If the sliding window is raised an audible and visual alarm will occur, but may be silenced by pressing the alarm silence key. Airflow readings will not be displayed during the warm-up period.

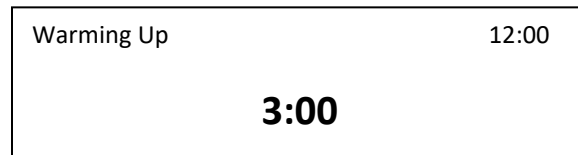

Once the warm-up period is complete, airflow readings and all system functions will operate and be displayed.

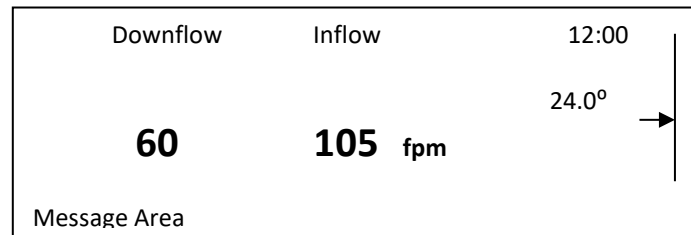

The top line will show the items being displayed along with the time of day. The center of the display will show the values of the items, the unit of measure and the temperature. The bottom of the display or message area will show active alarms and other status information. The right hand side of the display will show a gauge depicting the

Status menus of filter life and auto timers may also be accessed in run mode. Press either ↑ or ↓ keys to move from one menu to the next. Auto timer menu will only indicate active timers as they count down.

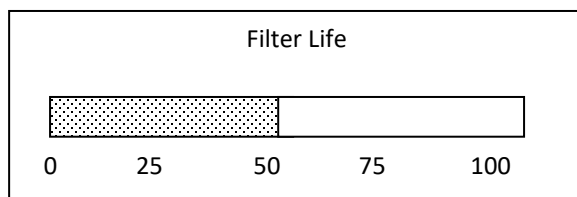

Auto Timers (hh.mm)	12:00
Ultraviolet Light	0:03:12
Fluorescent Light	5:48:32
Outlet Power	5:48:34



### 6.1.6 Nite Care Mode

The NU-543 may be configured to allow the DC ECM motor to continue to run at a lower rate with the sliding window closed allowing the workzone interior to be continually HEPA filtered. If the Nite Care mode is configured, the blower must be on (green LED above blower key will blink) and the window closed for it to be activated. In addition, the fluorescent light will be disabled. The UV light may be turned on if installed.

Airflow Idle	XX:XX
Nite Care On	

### 6.1.7 Standby/Run Mode Alarms

If present, standby/run mode alarms will be both visual and audible, the red alarm LED oval will turn on, and the message area on the display will indicate the alarm description. Audible alarms will produce an alarm tone for 30 seconds, then ring back for 2 seconds of every 5 seconds. Pressing the alarm silence key will silence the audible alarm for 15 minutes initially then will start the ring back function again.

The bottom of the display or message area will indicate alarms, errors or other notable conditions. Since the message area is limited to one line of text, only the highest priority message will be indicated. The list below represents the highest to lowest priority.

- 1) New Firmware Loaded
- 2) Internal Board Failure
- 3) Power on Reset
- 4) Velocity Sensor Error
- 5) Velocity Comm Failure
- 6) Velocity Alarm
- 7) Blower Inhibited
- 8) Blower RPM Failure
- 9) Nite Care On
- 10) Window Closed
- 11) Window High
- 12) Window Low
- 13) Replace UV Light

 **Note:** The above messages are described in greater detail in section 8.

## 6.1.8 Operator Main Menu

The operator main menu allows the user to access and update basic system set up.

### 6.1.8.1 Access and Navigation

To access press and hold ENT key for 3 seconds until the menu appears.

Main Menu	
Time Menu	
UV Lamp Hours	3356
Temperature	75.0
Blower On/Off Password	none

Navigation through the system can be accomplished by the following:

- Press ↑ or ↓ keys to select a menu item which will be highlighted inversely. Menu selection moves in a round robin pattern.
- Press ENT key on a selected menu item will either:
  - 1) Drill further down the menu tree
  - 2) Allow editing of the item value which will now be highlighted.
    - Press ↑ or ↓ key to change the selected value
    - Press ENT key to accept the change



### 6.1.8.2 Time Menu

The time menu contains both time of day and auto timer duration. Upon selecting the time menu from the main menu the display will indicate the following:

Time Menu	
Time of Day	
Auto Timer Duration	

- **Time of Day**
  - Press ENT key to select time of day. The display will indicate the following:

Time Display format:	24 Hr
10:43:00	

- Press ENT key to advance through the following items; starting with the display format which is defaulted to 24 Hr:
  - Display format; 24 Hr or 12 Hr, will indicate am (pm if in 12 hr)
  - Hour
  - Minute
  - Second
- Press ↑ or ↓ key to change value of highlighted item
- Press ENT key to accept value and advance through the items. On the last item the display will return to the time menu.

- **Auto Timer Duration**

Auto timer duration timers are countdown timers for the functions displayed once time is entered into a function. The timer will begin to countdown upon the start of that function (i.e. press UV light key to start timing the UV light). The LED indicator above the function key will start to blink indicating the timer function. If the LED indicator was full on, no timer function is present. As the timer expires the function will turn off.

Each timer will indicate the run time in hours and minutes. The minute hold will increase or decrease in 15 minute intervals. The maximum timer duration is 8 hours.

Auto Timer Duration (hh.mm)	
Ultraviolet Light	0:45
Fluorescent Light	7:00
Outlet Power	8:00

- Press ↑ or ↓ key to select menu item
- Press ENT key to highlight time display
- Press ↑ or ↓ key to desired time.
- Press ENT key to accept time value

### 6.1.8.3 UV lamp hours (if UV light option is installed)

UV lamp hours will indicate the number of hours the UV light has been on. When the lamp hours reach 5000, a message will be provided to replace UV light. Once the replacement is complete, the UV lamp hours may be reset by the following:

- Press ↑ or ↓ key to select menu item
- Press ENT key to highlight the hours
- Press ↑ and ↓ keys simultaneously until hours clear
- Press ENT key to accept "0" reset value.

### 6.1.8.4 Temperature

The temperature displayed is provided by the airflow sensor in the cabinet's exhaust airstream. The temperature displayed may indicate a slightly higher value than the laboratory room temperature due to some heat generation of the cabinet itself. However, the temperature may be adjusted by an offset or (deviation from the indicated temperature, plus or minus in tenths of a degree) calibration procedure by the following:

- Press ↑ or ↓ key to select menu item
- Press ENT key to highlight the temperature value
- Press ↑ or ↓ key to enter the amount of offset (increase or decrease from displayed value)
- Press ENT key to accept offset and display new temperature value.

### 6.1.8.5 Blower On/Off password (default off)

Blower On/Off password allows the cabinet user to place a 3 key sequence requirement to turn on the blower. The 3 key sequence will be a combination of the blower and hidden key (hidden key is located just above blower LED under the center of the Airflow symbol). During the 3 key sequence, the first 2 key strokes will not have any audible feedback. The last key stroke will have the normal audible feedback indicating a successful password. The 3 sequence combinations are the following:

None  
 B-B-H  
 B-H-B  
 B-H-H  
 H-B-B  
 H-B-H  
 H-H-B

To select a password sequence, perform the following:

- Press ↑ or ↓ key to select menu item
- Press ENT key to highlight the password
- Press ↑ or ↓ key to desired password
- Press ENT key to accept password

## 6.2 Operating Guidelines

The intent herein is to present general operational guidelines that will aid in the use of the Laminar Flow Biosafety Cabinet (LFBSC) to control airborne contaminants of low to moderate risk as stated in Technical Report Number FPS 56500000001, prepared by Dow Chemical U.S.A. for the National Cancer Institute, May 1, 1972.

Procedure protocols defined in terms of the barrier or control concepts unique to LFBSC must be developed in order to obtain a maximum potential for safety and protection. The pre-planning necessary to develop these protocols is based on several fundamental considerations, each of which will contribute to optimum benefits from the equipment:

- a. Know your "Safe Work Area"
- b. Minimize penetration of "air curtain"
- c. Minimize room activity
- d. Utilize unidirectional airflow
- e. Employ aseptic techniques

### 6.2.1 Know your "Safe Working Area"

The LFBSC safe working area is basically the worktray or depressed area. All work should be performed on or above the worktray. The area on or above the front grill is a non-safe working area.

 **NOTE:** It is important to maintain an air gap on both sides of the worktray before fastening in place. The work tray as being part of the cabinet system has been designed to load up to 100 lbs. (45.4kg) of work materials. Any additional loading should be evaluated by appropriate safety personnel.

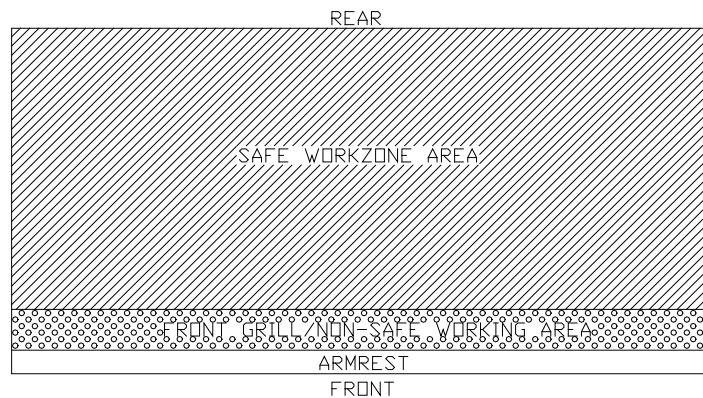

### 6.2.2 Minimize Penetration of "Air Curtain"

The minimum number of items necessary should be placed into the cabinet to prevent overloading, but the work should also be planned to minimize the number of times an operator's hands and arms must enter and leave the air curtain at the open face. The ideal situation is to have everything needed for the complete procedure placed in the hood before starting, so that nothing need pass in or out through the air barrier at the face until the procedure is completed. This is especially important in working with moderate risk agents.

Avoid lifting arms/hands inside the cabinet above the level of the work opening. This presents an inclined plane from hands to elbows along which the downflow of air may run to, and possibly out, the open face.

 **NOTE:** When working with agents of lower risk, it is not as important for all materials to be placed in the cabinet before starting or for the procedure to be completely finished before materials are removed. Also, the time period for the cabinet may be continued over a longer extended period, during which entries and withdrawals from the cabinet may be made.

### 6.2.3 Minimize Room Activity

Activity in the room itself should be held to a minimum. Unnecessary activity may create disruptive air currents as well as interfere with the work of the operator. A person walking past the front of a cabinet can cause draft velocities up to 175 fpm (.89 m/s), which are sufficient to disrupt the air balance of the LFBSC.

#### **6.2.4 Utilize Unidirectional Air Flow**

The operator must keep two important facts in mind: (1) The air, as supplied to the work area through filters from the top, is contaminant free and (2) Airborne contamination generated in the work area is controlled by the unidirectional flow of parallel air streams in a top-to-bottom direction.

A solid object placed in a laminar air stream will disrupt the parallel flow and consequently, the capability of controlling lateral movement of airborne particulates. A cone of turbulence extends below the object and laminarity of the air stream is not regained until a point is reached downstream, approximately equal to three to six times the diameter of the object. Within the parameters of this cone, particles may be carried laterally by multidirectional eddy currents.

Transfer of viable materials and manipulations, which may generate aerosols, should not be performed above sterile or uninoculated materials. Items should be localized on the work surface in "clean" and "dirty" groups.

#### **6.2.5 Employ Aseptic Technique**

The operator must not assume an attitude of "let the cabinet do it" when performing procedures within a LFBSC. Properly balanced and properly used cabinets will do an excellent job of controlling airborne contamination and containing viable agents, but the cabinet will not eliminate contact transmission of contamination. Normal laboratory contamination control procedures and basic aseptic techniques are necessary to obtain maximum benefit from the cabinet. For example, open bottle, tube or flask mounts should be kept as parallel as possible to the downflow to minimize capture of chance particulates. This precaution is merely an extension of good aseptic technique as practiced on open bench tops. The standard laboratory practices designed to minimize creation and/or release of aerosols to the environment should not be discontinued.

Items of equipment in direct contact with the etiologic agent must remain in the cabinet until enclosed or until surface-decontaminated. Trays of discard pipettes must be covered before removal from the cabinet (aluminum foil may substitute for fabricated covers).

If an accident occurs which spills or splatters suspensions of etiologic agent around the work area, all surfaces and items in the cabinet must be surface-decontaminated before being removed.

Applying a burner flame to flask and tube necks when mating surfaces of sterile assemblies is a conventional method of minimizing chance contamination. However, the efficiency of this operation is usually related to the removal of airborne contamination occurring while the item is uncovered. If the manipulation is carried out in an environment free of airborne particulates, then the need for the flaming operation is essentially removed. This is one of the additional advantages of the LFBSC - use of the gas burner is seldom necessary. The gas burner flame in one of these cabinets not only contributes significantly to the heat build-up, it also disrupts the laminar air streams which must be maintained for maximum efficiency. If the procedure demands use of a flame, A BUNSEN BURNER WITH ON DEMAND IGNITION IS RECOMMENDED. DO NOT USE CONSTANT FLAME GAS BURNERS. It should also be only used from the center of the work surface to the right rear where resulting air turbulence will have a minimal effect. DO NOT USE GAS BURNER ON THE LEFT SIDE OF THE WORK SURFACE DUE TO ITS INFLUENCE ON THE ELECTRONIC AIRFLOW CONTROL SYSTEM. If cabinet air is inadvertently turned off, the flame could damage the HEPA filters.

## 6.3 Operating Sequence

### 6.3.1 Start Up

Turn on cabinet blower and lights and check air intake and exhaust portals of the cabinet to make sure they are unobstructed. The electronic airflow control system will automatically control airflows to specified setpoints. However, upon filter loading, the cabinet may be required to be re-balanced or filters replaced. Only a qualified maintenance technician should perform cabinet balancing and filter replacement.



**NOTE:** Some cabinets are equipped with ultraviolet (UV) lights. Good procedure includes the decontamination or wipe down of cabinet surfaces with chemical disinfectant before work commences. This practice eliminates the need for UV lights, whose primary utility in this application is inactivation of surface contamination since the filters effectively remove all airborne contaminants. UV lights, therefore, are not recommended in the LFBSC.

Allow blowers to operate for a minimum of 15 minutes before aseptic manipulations are begun in the cabinet. If the filtered air exhausted from the cabinet is discharged into the room, as in some installations, an additional advantage is obtained from purification (filtration) of the room air circulated through the equipment. Because of this characteristic contributing to the quality of the laboratory environment, some owners of LFBSC's leave them in operation beyond the time of actual use.

### 6.3.2 Wipe Down

The interior surfaces of the workspace should next be disinfected (see Cleaning Procedures) by wiping them thoroughly with 70% alcohol or similar non-corrosive anti-microbial agents. USE OF CHLORINATED OR HALOGEN MATERIALS IN THE CABINET MAY DAMAGE STAINLESS STEEL.

### 6.3.3 Materials and Equipment

The apparatus and materials should next be placed into the cabinet. Care must be exercised that no items be placed over the front intake grills. Materials should be arranged so that clean, dirty (used), and virus materials are well separated. Passage of contaminated materials over uninoculated cultures or clean glassware should be avoided and transfer of viable materials should be performed as deeply into the cabinet (away from open face) as possible.

### 6.3.4 Air Purge

Additional purging of the workspace without user activity should be allowed for 2-3 minutes after materials and apparatus have been placed in it. This will rid the area of all "loose" contamination that may have been introduced with the items.

### 6.3.5 Perform Work

The work can now be performed. The technician performing the work is encouraged to wear a long-sleeved gown with knit cuffs and rubber gloves. This will minimize the shedding of skin flora into the work area and concurrently protect the hands and arms from viable agent contamination. At a minimum, the hands and arms should be washed well with germicidal soap before and after work in the cabinet.

For the preparation of antineoplastic drugs, the following procedures summarize those contained in OSHA's guidelines to Controlling Occupational Exposure to Hazardous Drugs. The OSHA document should be thoroughly studied and reviewed prior to drug preparation in the cabinet. It may be found at this website:

[https://www.osha.gov/SLTC/hazardousdrugs/controlling\\_occex\\_hazardousdrugs.html](https://www.osha.gov/SLTC/hazardousdrugs/controlling_occex_hazardousdrugs.html)

- a. A sterile plastic-backed absorbent drape should be placed on the work surface during mixing procedures. The drape should be exchanged whenever significant spillage occurs, or at the end of each production sequence.
- b. Vials should be vented with a filter needle to eliminate internal pressure or vacuum.
- c. Before opening ampoules, care should be taken to insure that no liquid remains in the tip of the ampoule. A sterile gauze sponge should be wrapped around the neck of the ampoule while opening.
- d. Final drug measurement should be performed prior to removing the needle from the stopper of the vial.
- e. A non-splash collection vessel should be available in the LFBSC to discard excess drug solutions.

### 6.3.6 Terminal Purging and Wipe Down

Following completion of work, allow the cabinet to run for 2-3 minute period without personnel activity to purge the cabinet. A surface disinfection of the interior surfaces (see Cleaning Procedures section) should be repeated after removal of all materials, cultures, apparatus, etc. A careful check of grills and diffuser grids should be made for spilled or splashed nutrients which may support fungus growth and resulting spore liberation that contaminates the protected work environment.

### 6.3.7 Paper Catch/Prefilter

A permanent paper catch is installed behind the rear divider panel of the work zone. This area forms the return air path to the motor/blower; and if the airflow is sufficiently blocked, it will cause an airflow alarm and affect the performance of the cabinet. Therefore, THE PAPER CATCH SHOULD BE CHECKED AND CLEANED ON A ROUTINE BASIS AS DETERMINED BY CABINET USE AND THE LAB ENVIRONMENT. At a minimum, the paper catch should be checked and cleansed on an annual basis during the certification process. However, if a lot of paper products (I.e. Sterile wipes) are used for procedure work and causing airflow alarms, a more routine (i.e. monthly, quarterly, bi-annual) check and clean would be recommended. Any paper removed must be properly disposed of as **Contaminated Hazardous Waste**. The above procedures also apply to all cabinets configured with a prefilter.

### 6.3.8 Shut Down

Turn off blowers and lights. Do not use cabinet as a depository for excess lab equipment during periods of non-operation. If antineoplastic agents are being prepared in the cabinet, it is recommended to let the cabinet run 24 hours per day. This lessens the possibility that contaminants may escape.

## 6.4 Ergonomics

Ergonomics, the study or accommodation of work practices is extremely important for proper cabinet usage and user health and safety. An evaluation of normal work practices should be performed with each user when working in a cabinet. Evaluation criteria should be at a minimum:

- a. Proper user posture
- b. Effective work zone layout for work practice
- c. Vision or sightlines

For each of the above evaluation criterion, several work aids may be supplied to accommodate the user.

- Ergonomic chair - A six-way articulating seat and back control for personalized adjustment to assure proper user posture. Be sure feet are resting on the floor, chair foot support or foot rest. Also be sure back is fully supported with proper chair adjustments.
- Forearm/elbow support - The cabinet is provided with a non-metallic forearm support on the work access opening. Periodic mini-breaks during work practice should be taken resting forearm to avoid stress and fatigue. Elbow rests that can provide support for particular work practices, such as pipetting are optional. Also available as an option, closed cell foam disposable forearm pads to reduce pressure points and add comfort.
- Effective workzone layout - Always prepare your work procedure to minimize reach to avoid neck and shoulder stress and fatigue. Rotating tables used to maximum workzone and minimize reach are optional.
- Vision and sightline - Always prepare your work procedure to eliminate glare and bright reflections on the window. Keep your window clean and sightlines clear to your effective workzone.

## 6.5 Cleaning Procedures

### 6.5.1 General

Cleaning laboratory equipment is important in terms of both functionality and general good housekeeping. The information provided below is intended to aid the development of facility Standard Operating Procedures (SOP's) for cleaning the equipment. It is strongly recommended that all cleaning materials used be tested and verified in terms of both effectiveness and material compatibility before they are written into the cleaning SOP documentation.

- a. The airflow blower should be operating during the cleaning process to maintain sterility and/or containment during the cleaning process.
- b. Raise window to gain additional access if desired.
- c. Apply appropriate cleaning material or surface disinfectant to surfaces. Most surface disinfectants require a specific contact time depending the materials used within the work zone. **CONSULT APPROPRIATE DISINFECTANT DOCUMENTATION FOR PROPER APPLICATION AND SAFETY PRECAUTIONS.**

c-1. Stainless steel (type 304) has noted material compatibility concerns with Acids, Chlorides and Halogens. **IF THESE MATERIALS ARE USED AND ALLOWED TO BE LEFT ON THE STAINLESS STEEL SURFACE, OXIDATION AND DEGRADATION WILL OCCUR.** Only by re-wiping surfaces with either sterile water or 70% IPA will remove harmful materials from the stainless steel surface.

Further information is available at the following: [http://www.parrinst.com/wp-content/uploads/downloads/2011/07/Parr\\_Stainless-Steels-Corrosion-Info.pdf](http://www.parrinst.com/wp-content/uploads/downloads/2011/07/Parr_Stainless-Steels-Corrosion-Info.pdf)

NOTE: NuAire does not offer any product warranty with respect to cleaning material compatibility. **USE AT YOUR OWN RISK!** The information provided above is from raw material suppliers and known general source documents for use to develop application cleaning SOP's.

NOTE: When cleaning the work area for the first several times, the new metal surfaces may produce some dark discoloration on the white cleaning wipes. Repeated cleaning will continuously reduce the amount of the discoloration material on the cleaning wipes over time.

## 6.6 Hazardous Drug Decontamination Procedures

This procedure is intended to provide guidance following a spillage and/or periodic maintenance, testing or relocation of the cabinet. Additional guidance can be provided by the CETA document CAG-005-2007 found at the CETA website: [www.CETAinternational.org](http://www.CETAinternational.org).

### 6.6.1 Preparation

Prior to beginning decontamination activity, personnel should wear proper personnel protection equipment (PPE) i.e. Tyvek<sup>1</sup> isolation gown, 2 pair of Nitrile gloves and a full-faced HEPA filtered respirator. All protective garments should be contained in 4 mil plastic bags and labeled for disposal as chemotherapy waste after completion of the procedure. For the purpose of this procedure, detailed procedures for cleaning a Class II LFBSC can be found in the 2006 ASHP Technical Assistance Bulletin ASHP Guidelines on Handling Hazardous Drugs<sup>2</sup>.

### 6.6.2 Procedure

- a. Make sure that the cabinet remains in operational mode with internal blower on.
- b. Open the hinged or sliding view screen and secure in the full open position.

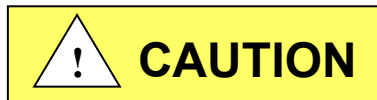

With the view screen in the full open position, personnel protection is compromised and a full faced HEPA filtered respirator must be worn.



- c. Clean all readily accessible surfaces of the cabinet.
- d. Remove perforated metal diffuser screen from the underside of the supply HEPA filter and place on the cabinet work tray.

 Note: Depending on the model, the diffuser screen is secured to the cabinet by #8-32 screws or 1/4" - 20 acorn nuts, 3 places. It is purposely a tight fit and is secured to the back wall with projecting threadless studs.

- e. Clean both sides of the perforated metal diffuser screen and remove it from the cabinet.
- f. Lift the cabinet work tray, clean both sides and remove it from the cabinet.
- g. Remove the front perforated grill, place on the cabinet floor and clean both sides. Remove from cabinet.
- h. Clean work tray supports.
- i. Working from top to bottom, clean all inside surfaces of the cabinet. Take care not to wet the HEPA filter. If liquid has collected in the plenum drain, aspirate it using IV tubing into an evacuated container. Label the evacuated container for disposal as chemotherapy waste.
- j. Clean the plenums drain area and wipe dry.
- k. If the cabinet requires maintenance and/or replacement of the HEPA filters, the operation should be halted at this point to allow trained personnel to complete replacement of the HEPA and/or maintenance action required.



### 6.6.3 Assembly

- a. Replace front grill (if removed).
- b. Replace the work tray and carefully tighten the thumbscrews.
- c. Replace perforated metal diffuser screen over the underside of the supply HEPA filter.
- d. Wipe down all exposed surfaces of the work area with 70% isopropyl alcohol.
- e. Prepare for aseptic operation.

<sup>1</sup> Available from Lab Safety Supply, Janesville, WI 53547-1368, or other laboratory, industrial, or hospital supply distributors.

<sup>2</sup> American Society of Hospital Pharmacists. 2006. ASHP Guidelines on Handling Hazardous Drugs *Am. J. Hosp. Pharm.* 63:1172-1193.

## 7.0 General Maintenance



**All maintenance actions on this equipment must be performed by a qualified technician who is familiar with the proper maintenance procedures required including both certification and repair.**

### 7.1 Decontamination

No maintenance should be performed on the interior of the LabGard® ES cabinet (area behind access panels) unless the cabinet has been microbiologically decontaminated, is known to be biologically clean, or known to be chemically inert. Surface disinfection is performed as specified in the Cleaning Procedures section.



**Hazardous Gases! Personal Protection Equipment Required.**



Decontamination using hazardous gas, vapor or mist must be performed in accordance with the specifications of NSF/ANSI 49, Annex I-2 (formerly Annex G) EN12469, Annex J or applicable national, state, province or local regulations

This procedure presents considerable risks and must be performed only by specially trained and authorized service personnel in accordance with applicable national safety regulations.

The decontaminate is generated either external or internal of the sealed cabinet. The quantity of decontaminate should follow standard or manufacturer's recommendations based on cabinet volume. The decontaminate process should follow standards or manufacturer's recommendations based on the decontaminate used.



**All decontaminate materials are hazardous (chemical-liquid, gas and vapor) (Flammable – process) and are required to be handled properly. Follow all product and process documentation and labelling.**

### 7.1.1 Manual Decon

1. Disconnect power to the cabinet. Remove screws at each upper side of the control center and allow the control center to rotate down, resting on the safety straps. Disconnect electrical connectors on left side. Disconnect electrical from right side. (Be sure to note the location of the supply and exhaust sensor wires before disconnecting them from the main board). Remove control center by disconnecting safety straps lifting the control cable up and away from cabinet. Fold and pinch tubing to seal.
2. Remove the front decorative panel via top/front fasteners.
3. Remove window assembly (both frame and window, either being manual, sliding, or automatic) via the upper and lower fasteners (Refer to BCD-16376). At this point, the sliding window assembly can be removed.
4. Remove exhaust sensor shrouds.
5. Remove the diffuser screen and gasket around perimeter of workzone (if present).
6. Prepare decontamination equipment. Reference decontamination procedure and use the following chart to calculate chemical requirements.

Cabinet Size	300	400	500	600
Cabinet Dimensions	58-7/8 x 28 x 34-3/8 in. (1.50 x .711 x .873 m)	58-7/8 x 28 x 46-3/8 (1.50 x .711 x 1.18 m)	58-7/8 x 28 x 58-3/8 (1.50 x .711 x 1.48m)	58-7/8 x 28 x 70-3/8 (1.50 x .739 x 1.88 m)
Cabinet Volume	32.79 cu. ft. (.929 cu. m)	44.24 cu. ft. (1.25 cu. m)	55.69 cu. ft. (1.58 cu. m)	67.14 cu. ft. (1.90 cu. m)

 **Note:** The outlets in the work area are energized as long as the cabinet is plugged in and switched on the front panel. Unplug the cabinet before decontamination equipment is plugged into these outlets. The control centers electrical connectors may be re-attached to utilize the cabinet's interior outlets and fan during the decontamination.

8. Set control center on its side resting on the left side of cabinet. Then plug in the 16-pin connector cable from the cabinet to the control center. Reconnect power to the cabinet. The outlets and blower can then be activated.
9. Seal front and top openings using plastic and tape.

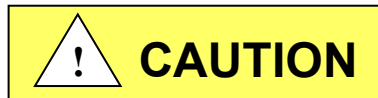

**BE SURE CABINET IS TOTALLY SEALED TO PREVENT ANY LABORATORY EXPOSURE TO DECONTAMINATION GAS, VAPOR OR MIST.**

10. Perform decontamination procedure.

### 7.1.2 Auto Decon

The Auto Decon process is intended to be used with any automated cabinet decontamination process (i.e hydrogen peroxide, chlorine dioxide, etc.) The automated decon process parameters are typically set up independently of the cabinet. Inlet and outlet ports from the automated decon machine are connected to the cabinet. The cabinet control system may be set up to run simultaneously aiding the decontaminate circulation throughout the cabinet during the entire decon cycle.

To validate two decon processes and associated cabinet set up procedure; NuAire utilized a Bioquell Clarus II H<sub>2</sub>O<sub>2</sub> and a Steris X10 the following process was performed by the Bioquell Clarus II.

1. Remove armrest via fasteners.
2. Remove exhaust shroud and sensor.
3. Seal top and front openings using either heavy plastic and duct tape or seal plates.  
Seal all joints with tape as indicated on drawing BCD-16509.

 **Note:** Top and front seal plates may be obtained by contacting NuAire representative or distributor.

4. Attach inlet and outlet connections to decontamination system along with pressure and/or concentration sensor if provided.

REV	ECO	DESCRIPTION	DATE	DFTM	CHKD
D	13035	ADDED ALTERNATE DECON	6/23/2016	TH	DSH

01/16

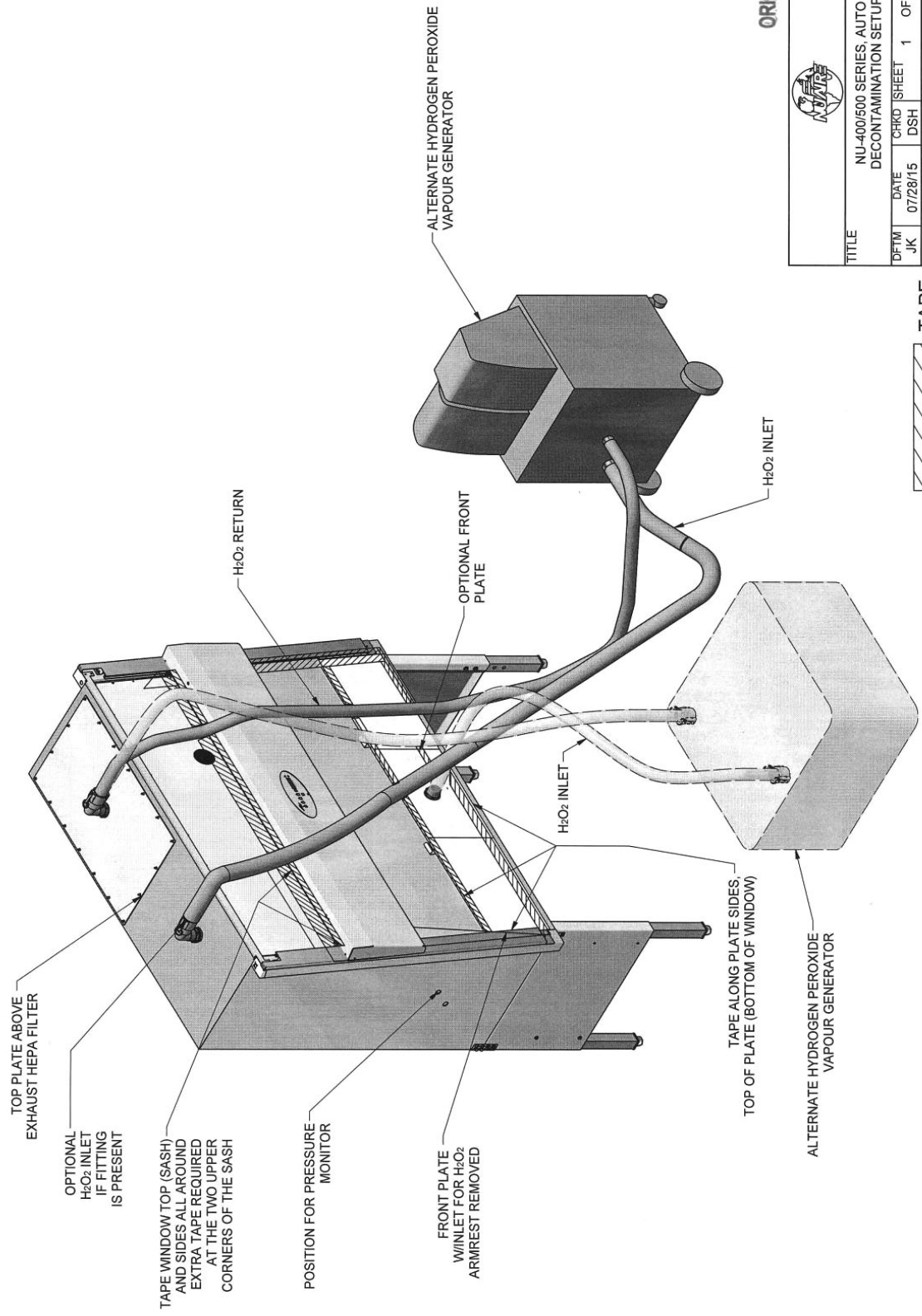

ORIGINAL

TITLE		NIJ-400/500 SERIES, AUTO DECONTAMINATION SETUP	
DFTM	DATE	CHKD	SHEET
JK	07/28/15	DSH	1 OF 1
DRAWING NUMBER		BCD-16509	

TAPE

Determine decontamination system cycle parameters. Note that system parameters will change for process type, as well as cabinet model and size.

For validation purposes, a LabGard® ES Model NU-543-600E was set using the following parameters on the Bioquell Clarus II:

Pressure Setpoint:	-10 Pa
Airflow Setpoint:	22 m <sub>3</sub> /hr
Delivery Temperature:	65°C
Conditioning Time:	10 min
Gassing Time:	40 min
Gassing Injection Rate:	6.0 g/min
Dwell Time:	90 min
Injection in Dwell:	ON
Dwell Injection Rate:	3.5 g/min
Aeration Delay:	60 min
Aeration Time:	600 min

The following process was performed by the Steris X10 using the LabGard ES Model NU-543-400

1. Blower is turned off.
2. Biological Indicators were placed at the exhaust filter, corner of working area and under the work tray of BSC or anywhere inside the cabinet.
3. Exhaust opening sealed with a metal plate and a tubing connection for the Hydrogen Peroxide (H<sub>2</sub>O<sub>2</sub>) return.
4. Front opening sealed with plastic film and a tubing connector mounting plate. Reference BCD-16509.
5. Edges of the front window sealed with a low residue tape.
6. Tubing connected to the inlet and outlet of X10.
7. Insertion of Hydrogen Peroxide (H<sub>2</sub>O<sub>2</sub>) sterilant cup and desiccant cartridge to X10.
8. Current BSC process selected.

Decontamination Process:

9. The X10 will perform one (1) Preheat, Dehumidification, Decontamination and Aeration after start of the program.
10. Preheat – The cabinet is heated to 31° C.
11. Dehumidification – Cabinet is dehumidified to 15% RH.
12. Condition – Sterilant vapor is added to sealed cabinet to target concentration.
13. Checked for any Hydrogen Peroxide (H<sub>2</sub>O<sub>2</sub>) leakage from the cabinet. Applied extra tape as needed.
14. Decontamination – The cabinet is filled with sterilant vapor for 45 minutes.
15. During the decontamination, the blower was activated for 1 minute every 15 minutes.

Aeration:

16. Aeration – The sterilant vapor is converted to water and oxygen by 3 options
  - a. Connect the exhaust to Fumehood or outdoors
  - b. Connect the AR60 Aerator which catalyzes the Hydrogen Peroxide (H<sub>2</sub>O<sub>2</sub>) vapor about 3 hours.
  - c. Run Aeration cycle of the X10 for about 10 hours.
17. Check the Hydrogen Peroxide (H<sub>2</sub>O<sub>2</sub>) level during the Aeration cycle and open the seal when level is less than 1ppm.

Biological indicators were removed and incubated for 7 days.

## Cabinet Auto Decontamination

Use the following procedure to allow the cabinet blower to automatically run at programmed intervals during the decontamination process.

To enter the service parameter menu, perform the following:



The following service parameter display should appear.

Service Parameters	
Configuration	
Setpoints	
Calibration	
<b>Options</b>	

- Press ↑ or ↓ keys to select option menu item.

Option Parameters	
Sync Outputs with Blower	
Function Options	
Blower Options	
<b>Auto Decontamination</b>	

- Press ↑ or ↓ keys to select Auto Decontamination menu item.

Enter decon cycle parameter information below and proceed to initiate the decon cycle for both the decontamination system and cabinet.

Auto Decontamination	
Total duration: (hh.mm)	3:00
Blower run time: (mm.ss)	1:00
Blower start schedule	
Initiate decon cycle	

Total duration is the total automated decontamination cycle time, so both the cabinet Auto Decontamination time duration and the automated decontamination system cycle time are sequenced and run together.

Blower run time is the length of time the blower will run during and of the (4) possible blower start times.

Blower start schedule is the start time of (4) possible blower start times during the decon cycle.

Blower Start Time	
Start blower at:	1:00
Start blower at:	1:30
Start blower at:	2:00
Start blower at:	2:30

Initiate decon cycle provides a short safety check list the must be answered yes before the decon cycle can be initiated.

Initiate Auto Decon	
Cabinet sealed:	No
Gas in/out connected:	No
Blower stopped:	No
Perform Auto Decon	

Once the Auto Decon cycle is initiated, the following display indicates cycle progress until the times reach the end of their duration.

Auto Decon in Progress		
0:00	Next blower	1:00
	Finished in	3:00
Press Alarm silence to abort		

## 7.2 LED Lamp Replacement

The two (T8) LED lamps are cool white and placed external to the cabinet to aid maintenance and minimize heat build-up within the cabinet. The life rating of the bulb is 50,000 hours for LED based on three-hour burning cycles.

To replace a lamp, it is necessary to remove the lamp assembly.

1. Switch cabinet light switch off.
2. Remove the screws at each upper side of the control center and allow the control center to rotate down, resting on the safety straps.
3. The lamp is now directly exposed for replacement.
4. The lamp is removed by displacing the bulb to one side against the compressible bulb holder and lifting out the lamp.
5. Reverse the procedure to reinstall the lamp assembly being careful not to pinch the safety straps, cable or tubing during closure of the control center.

<sup>1</sup> Available from Lab Safety Supply, Janesville, WI 53547-1368, or other laboratory, industrial, or hospital supply distributor

### 7.3 HEPA Filter/Motor Replacement

The HEPA Filters do not need replacement under normal usage and barring an accident (a puncture), until the efflux velocity cannot be maintained or the access inflow velocity cannot be maintained at 100 LFPM (.51 m/s) (min.). This may permit the average downflow velocity to be as low as 55 LFPM (.28 m/s) as long as no point falls below 20% of the average downflow velocity.

The HEPA Filters should not be replaced until the entire cabinet has been decontaminated or known to be biologically "clean".

#### 7.3.1 Procedure



**Disconnect electrical power from the cabinet before attempting any maintenance action.**

Step 1: Remove screws at each upper side of the control center and allow the control center to rotate down, resting on the safety straps. Second, remove the front decorative panel which is held into position by (3) knurled nuts on the top edge and snap fit bullet catches on the bottom.

Step 2: Place sliding window into lowest position \* and remove front filter panel, which is held into position by Phillip pan head screws. Once the screws are removed, the panel is held into position by smooth weld studs located on the top corner of the front filter panel. Use the window stop brackets as handles to remove the panel.

 Note: Screws are used in lieu of acorn nuts, and lock washers.  
The screws have O-rings and should be replaced if damaged or badly deformed.

The interior of the cabinet is now fully exposed for replacement of the filters and motor/blower.

\* The lowest window position will require the armrest to be removed.

#### Step 3: Filter Removal

It is not always necessary to replace both the supply and exhaust filters at the same time. If during the course of certifications, the downflow always falls off while the exhaust increases the supply filter is "loading" faster than the exhaust filter and only the supply filter may need replacement. The opposite might also happen depending upon many factors.

a. To remove the supply HEPA filter:

1. Remove the plenum screws in front of the supply HEPA filter.
2. Lift the permanent plenum and hold up with wire strap.
3. Carefully remove the supply filter. Direct exposure should be avoided.

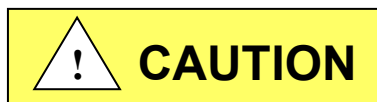

Dispose of spent HEPA filters properly. Avoid direct contact to "dirty side" of the filters. Place in sealed bag and label all waste containers/cartons based on type of hazard. Follow all Local, State and Federal guidelines for disposal of HEPA filter solid waste.

b. To remove the exhaust HEPA filter:

1. Relax the exhaust filter seal loading mechanism by turning the four threaded bolts counterclockwise until one can see a definite release of the loading springs.
2. Pull the exhaust choke tray free and remove the filter. It is not necessary to remove the tray, although it is free to move forward several inches, if necessary, to free the HEPA filter.

Step 4: Filter Installation

When installing new filters, USE ONLY NUAIRE SPECIFIED FILTERS FOR REPLACEMENT.

Description:	Supply HEPA Filter	Exhaust HEPA Filter
Efficiency:	99.99% @ 0.3 Micron	99.99% @ 0.3 Micron
Airflow Rating:	100 fpm @ .55 ± .05" w.g. per sq. ft.	250 fpm @ .45 ± .05" w.g. per sq. ft.
Frame Type:	Metal	Metal

NU-543-300

NuAire Part Number:	A-980979-04	A-980957-21
Filter Size:	21" (533mm) x 32" (813mm) x 3" (76mm)	20" (508mm) x 14" (356mm) x 11 1/2" (292mm)
Filter Manufacturer:	Camfil Farr	Camfil Farr

NU-543-400

NuAire Part Number:	A-980979-01	A-980957-12
Filter Size:	21" (533mm) x 44" (1118mm) x 3" (76mm)	20" (508mm) x 22" (559mm) x 11 1/2" (292mm)
Filter Manufacturer:	Camfil Farr	Camfil Farr

NU-543-500

NuAire Part Number:	A-980979-02	A-980957-13
Filter Size:	21" (533mm) x 56" (1422mm) x 3" (76mm)	20" (508mm) x 30" (762mm) x 11 1/2" (292mm)
Filter Manufacturer:	Camfil Farr	Camfil Farr

NU-543-600

NuAire Part Number:	A-980979-03	A-980957-14
Filter Size:	21" (533mm) x 68" (1727mm) x 3" (76mm)	20" (508mm) x 36" (914mm) x 11 1/2" (292mm)
Filter Manufacturer:	Camfil Farr	Camfil Farr



- a. To install the supply filter, simply reverse the procedure outlines in Step 3a, above.

 **Note:** Be sure to open the choke plate fully before inserting the filter into the tray.  
This will assist in adjusting the airflow.

- b. To install the exhaust filter, apply a thin layer of silicone grease to the top and bottom gaskets of the filter and carefully insert into the exhaust choke tray.

Position the filter frame within the outside walls of the exhaust opening on the top of the hood.  
Tighten the spring loaded bolts, 4 places, depressing the gasket material by 1/8 inch (3mm)

#### Step 5: Motor/Blower Assembly Removal

- a. It is recommended that the motor/blower to be removed as a single unit. To remove, disconnect electrical connections to the motor, remove the HEPEX pressure plenum and unbolt the motor/blower assembly from the roof of the cabinet (4 places). Always inspect the rubber isolation motor mounts and replace those that are cracked or visibly show stress.
- b. Replace the motor exactly as originally installed in the blower housing, paying particular attention to the correct electrical connections (see Electrical Schematic).
- c. Re-install the new motor/blower assembly.

## 7.4 Sliding Window Replacement and Manual Adjustment

The sliding window replacement is accomplished by removing the front decorative panel, control center, and window glide assemblies. The sliding window adjustment may be required due to everyday use over the life of the cabinet. Both window glides are adjustable by a set screw and tension screw method. When adjusting the sliding window, be sure to verify proper micro switch operation. If the sliding window is too loose, it will not properly activate the micro switches, thus causing potential operational malfunctions to occur. If the window counter balance experiences a fault, window function must be verified (the sliding window retention or ability to slow the rate of fall). See Sliding Window Retention Verification in the Inspection Report).

## 7.5 Airflow Control System Setup and Calibration

### 7.5.1 General

The operation of the NU-543 cabinet requires that the setup and calibration procedures be performed in order to certify or commission the cabinet for usage. The setup and calibration procedures performed **ONLY BY THE CABINET CERTIFIER** ensure that cabinet's setpoints are verified and that the airflow monitor sensors are calibrated to read the correct values. Press MENU to access Calibration/Service parameter.

To enter the service parameter menu, perform the following:



3 key sequence.



The following service parameter display should appear

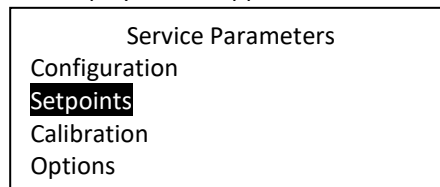

Navigation through the service parameter menu is the same as the operator menu.

- Press ↑ on ↓ keys to select a menu item which will be highlighted inversely. Menu selection moved in a round robin pattern.
- Press ENT key on a selected menu item will either:
  - 3) Drill further down the menu tree
  - 4) Allow editing of the item value which will now be highlighted.
    - Press ↑ or ↓ key to change the selected value
    - Press ENT key to accept the change



### 7.5.2 Configuration Parameters

Configuration parameters identify both user desired and required functional control system characteristics. User desired parameters includes language, flow units, temp units and logo. Requires functional parameters include motor type, cabinet size which assures proper performance characteristics.

If the cabinet blower operation is intended to be on 24/7, Blow on Sleep Mode should be turned on to avoid display burn out over time.

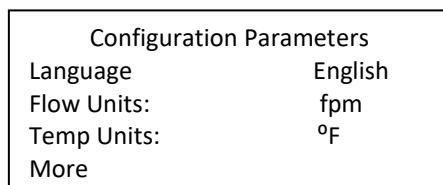

Parameter value choices:

Language: **English**, Spanish, German, French, Chinese, Japanese

Flow Units: m/s, **fpm**

Temp Units: °C, **°F**

Logo: NuAire

Motor Type: **ECM AUTO**, EC FIXED, ECM FIXED

Cabinet Size: 3 ft., **4 ft.**, 5 ft., 6 ft. Lam 3-4 ft., Lam 5-6 ft.

Blow on Sleep Mode: On, **Off**

**Bold** items represent default parameters

**Note:**

When the Blower on sleep mode **On**, the display will go blank after 5 minutes of the last event, any new event (key push, alarm or alert message) will bring back the display for another 5 minutes and the display will go blank again. When the blower on sleep mode **Off**, the display will not go blank

### 7.5.3 Setpoint Parameters

Setpoint parameters establish both the nominal airflow velocity, as well as the alarm limit velocities. Typically these are default values factory set for the required airflow range as tested and listed by 3<sup>rd</sup> party agencies. However, they may be altered in special cases for modified non-listed special cabinets. In addition to setpoints, filter life parameters are established using motor rpm. To determine filter life, the starting motor rpm is entered after the first airflow calibration is performed with clean filters. The maximum rpm is a known fixed value based on the DC ECM motor used. The difference between the maximum and current rpm determines the filter life percentage. The filter life percentage starts at 100% and as the current rpm increases due to filter loading, the filter life decreases.

Setpoints	
Inflow	
Filter Life	
DnFlow Set Pt	60

#### Inflow Velocity

Inflow Velocity (fpm)	
Low Limit:	90
Setpoint:	105
High Limit:	120

#### Default values

Low Limit 90fpm  
Setpoint 105fpm  
High Limit 120fpm



Note: The high and low setpoints are values are relative velocity values, not absolute. This means the actual value if measured from the nominal set point will be less than the stated value because of bias or non-linearity of the sensor measurement itself (i.e. the low alarm trip point will be between 94 fpm to 98 fpm if measured using alarm verification, not 90 fpm).

#### Filter Life

Filter Life	
Initial rpm:	1000
Latest rpm:	1100
Maximum rpm:	1375

#### Filter Life Calibration

$\text{Maximum rpm} - \text{initial rpm} = \text{Total available rpm}$   
 $\text{Total available rpm} - \text{latest rpm} = \text{Filter rpm available}$   
 $\text{Filter rpm available} \div \text{total available rpm} = (\text{Filter rpm used} - 1) \times 100 = \text{HEPA filter life}$

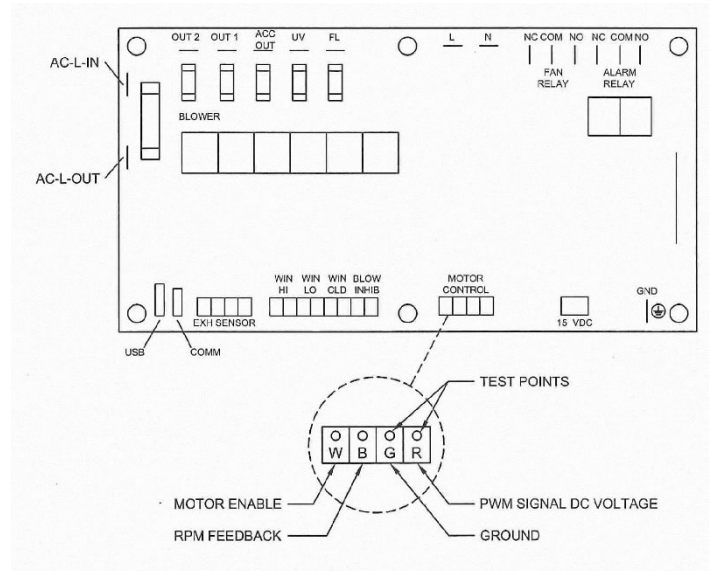

#### 7.5.4 Airflow Calibrations

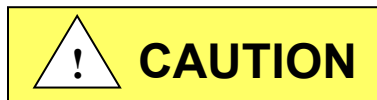

**Failure to calibrate airflow to the specified requirements may result in unsafe conditions of performance (i.e. product and/or personnel protection, noise and vibration)**

The NU-543 airflow calibration consists of adjustments to balance the airflow within the cabinet. **THIS WORK SHOULD BE DONE ONLY BY A QUALIFIED TECHNICIAN WHO CAN MEASURE THE AIRFLOW FROM THE FILTERS WITH A SUITABLE VELOMETER.** NuAire provides two adjustments to balance the airflow within the cabinet. These are:

- a. PWM signal adjust via calibration parameter menu
- b. exhaust filter choke

The PWM signal or blower speed adjustment establishes the motor speed controls curve starting point of the programmed internal reference performance curve while the choke adjusts or balances the exhaust airflow as well as makes up for filter resistance tolerances. Since it has been NuAire's experience that the filters may not "load" evenly, choke adjustments may be necessary for proper cabinet airflow balance and performance.

DC ECM motor PWM signal DC voltage should also be monitored and recorded upon final calibration. The DC voltage may be measured using a digital voltmeter. The two test points to measure DC ECM motor voltage are located on the DC motor connector on the main control board.

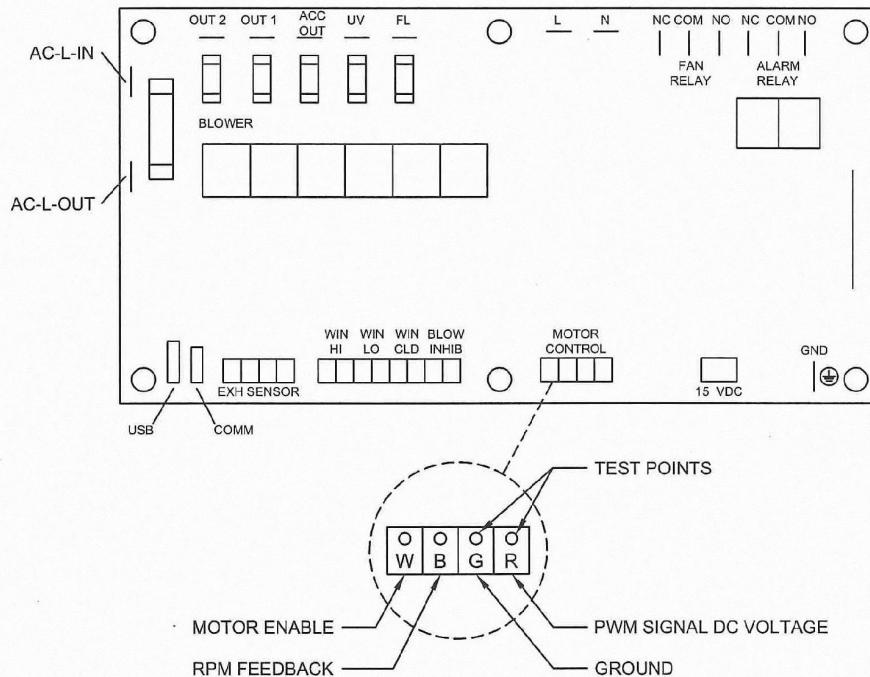

The cabinet is considered to be certifiable if the following airflow measurements are present:

- a. Downflow average: 60 LFPM  $\pm$  5 LFPM (.30 m/s  $\pm$  .025 m/s).
- b. Inflow average: 105 LFPM  $\pm$  5 LFPM (.53 m/s  $\pm$  .025 m/s) using the direct inflow measurement method or constricted 3 inch (76mm) high access opening measurement method.

Note: It is recommended to perform the airflow calibration process at least annually to optimize both the airflow control and IntelFlow™ monitor systems.

#### 7.5.4.1 Downflow Calibration

- Step 1: Place a velometer in the cabinet workzone on the horizontal plane 4 inches (102mm) above the bottom edge of the viewing window. Spot check several points on the recommended downflow velocity test grid in table 7.0
- Step 2: If necessary, enter blower speed parameter.

Calibration Parameters	
Blower Speed	
Sensor value adjust	
Alarm validation Sec	30
Alarm verification	

- Step 3: Adjust blower speed with  $\uparrow$  (increase) and  $\downarrow$  (decrease) as needed.

Normal Blower Calibration	
<b>105</b>	1020rpm, 50.1%
	fpm, 26.0°
	Settling time

**Note:** As the blower speed is adjusted, a settling countdown timer will appear.

After blower speed adjustment is made, the settling timer is used to allow enough time for the controller to receive the proper amount of rpm feedback to establish a valid base line point. There are no limits on the number of adjustments that can be made.

Step 4: Proceed to inflow calibration with blower speed menu on display.

#### 7.5.4.2 Inflow Calibration

Step 1: Measure the inflow velocity using the recommended procedure found in Table 7.0. If necessary, adjust the exhaust filter choke, located under the front decorative panel, to achieve the correct average inflow velocity within the stated range of  $105 \pm 5$  LFPM ( $.53 \pm .025$  m/s).

- Less than 100 LFPM (.51 m/s);  
First open the choke plate or make sure it is open.  
If this is insufficient, then increase blower speed.
- Greater than 110LFPM (.56 m/s)  
First decrease blower speed to achieve  $\frac{1}{2}$  the exhaust excess, then close the choke plate to achieve the balance. In this fashion, the downflow should remain nearly constant (i.e. what the reduced speed took away, the choke plate restores).

 **Note:** The choke plate adjustment requires a standard blade screwdriver. To adjust, loosen the liquid-tight fitting around the choke adjustment shaft. While monitoring the exhaust flow to check position, turning the choke adjustment shaft clockwise will open the choke while turning counter clockwise closed the choke.

Step 2: Once exhaust adjustment is complete, return to the downflow calibration process and measure average downflow velocity. If the downflow average remains within the correct range, the calibration is complete.

- Press ENT key to accept and enter the blower speed calibration point (If the blower speed calibration point was not successfully entered; a half second audible alarm will occur. The calibration process must then be repeated for successful entry of blower speed calibration point.)

If not, readjust as necessary to obtain the correct calibration range. Once entire cabinet has been balanced, tighten liquid-tight fastener around choke adjustment shaft.

### 7.5.4.3 Sensor Value Adjust

From calibration parameter menu, select and press ENT key for sensor value adjust.

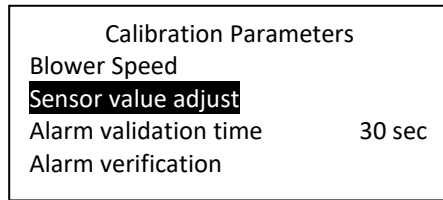

Select and press ENT key for inflow velocity

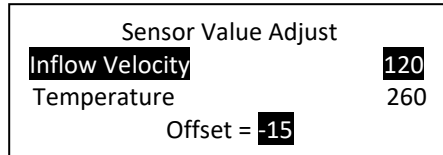

The actual inflow value and offset will be highlighted.

Pressing the ↑ or ↓ keys will increase or decrease the amount of airflow velocity offset shown on the bottom of the display.

Using the measured average airflow velocity obtained (i.e. 105fpm) enter the amount of offset necessary from the actual sensor velocity value (i.e. 120fpm) to achieve the measured or intended display value (i.e. 120fpm -15 = 105fpm). Offset value may be positive or negative as needed. Once desired offset value is achieved, press ENT key to accept.



### 7.5.4.4 Alarm Verification

If desired, the alarm setpoint can be verified by entering into the alarm verification menu.

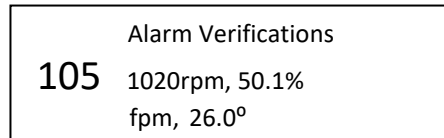

The airflow alarm is always active in this menu, so if the blower is turned on in this menu, an airflow alarm will be active until the airflow is above the low alarm limit.

Using the ↑ and ↓ key adjusts blower speed as necessary to activate a low or high airflow alarm. Measure either downflow or inflow at the alarm point to verify limits.

#### 7.5.4.5 Nite Care Calibration

The Nite Care mode is defaulted to operate the blower at approximately 600 rpm or a 14% duty cycle. However, if desired the Nite Care blower speed can be adjusted higher or lower by performing the following:



The following service parameter display should appear

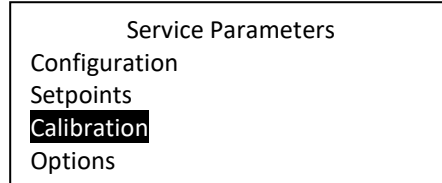

- Press ↑ and ↓ to select calibration
- Select and press ENT key for blower speed calibration
- Select and press ENT key for Nite Care

Adjust blower speed with ↑ (increase) and ↓ (decrease) as needed.

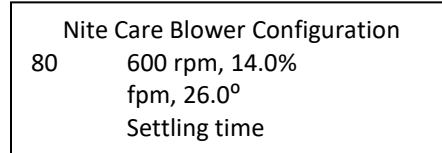

- Press ENT key to accept Nite Care blower speed calibration



Table 7.0  
Recommended Measurement Methods for Cabinet Downflow and Inflow

A. Downflow Measurement

- a. Recommended Instruments: TSI 8355 Thermo anemometer
- b. Procedure: Supply filter efflux is measured on a grid, in a horizontal plane 4 inches (102mm) above the bottom edge of the window. No reading should be taken closer than 6 inches (152mm) from the inside perimeter.
- c. Test Data - Inches (mm):

Model Size Window Access Height											
300 10/8/12				6.25 (159)	13.542 (344)	20.834 (529)	28.125 (714)				
	400 10/8/12			7.0 (178)	12.396 (315)	17.792 (452)	23.188 (589)	28.584 (726)	33.980 (863)	39.375 (1000)	
		500 10/8/12		7.25 (184)	13.518 (343)	19.786 (503)	26.054 (662)	32.322 (821)	38.590 (980)	44.858 (1139)	51.125 (1229)
			600 10/8/12	7.5 (191)	15.410 (391)	23.320 (592)	31.230 (793)	39.140 (994)	47.050 (1195)	54.960 (1396)	62.870 (1597)
6.25 (159)	7.0 (178)	7.250 (184)	7.5 (191)								
12.5 (318)	12.5 (318)	12.5 (318)	12.5 (318)								
18.750 (476)	18.0 (457)	17.750 (451)	17.5 (445)								

Number of Readings:	Average Velocity	ft./min.(m/s)
---------------------	------------------	---------------

- d. Acceptance Criteria:
  - 1. Average downflow velocity = 55 to 65 fpm (.28 to .33 m/s)
  - 2. Individual readings must be within  $\pm 20\%$  or  $\pm 16\text{fpm}$  ( $\pm 0.08\text{m/s}$ ) whichever is greater (factory test) or  $\pm 25\%$  or  $\pm 16\text{fpm}$  ( $\pm 0.08\text{m/s}$ ) whichever is greater (field test) from the average downflow velocity.

B. Inflow Measurement

- a. Recommended Instrument: Shortridge Flowhood ADM-870 or TSI 8355 Thermo anemometer.
- b. Primary Procedure:  
The primary procedure to determine inflow velocity uses a Direct Inflow Measurement (DIM) Instrument (i.e. Shortridge flowhood). The DIM Instrument can be used directly on the cabinet with NO CORRECTION FACTORS REQUIRED if operated in the local density default mode. NSF has tested the cabinet and established listed air velocities. Use duct tape to secure the DIM Instrument to the cabinet preventing any sneak air paths from occurring.

The DIM Instrument will read inflow volume (i.e. CFM). Use the window access opening area to calculate inflow velocity.

Alternate Procedure:

The alternative procedure to determine inflow velocity uses a thermo anemometer in a constricted window access opening of 3 inches (76mm) with the armrest removed. Inflow air velocity is measured in the center of the constricted opening 1-1/2 inches (38mm) above the work access opening on the following specified grid. Use the correction factor table to calculate the inflow velocity.

c. Test Data - Inches (mm):

1. DIM Measurement

Inflow Volume ft. <sup>3</sup> /min.(m <sup>3</sup> /s)	Access Opening ft. <sup>2</sup> (m <sup>2</sup> )	Inflow Velocity ft./min(m/s)
--	--	---------------------------------

2. Constricted 3 inch (76mm) high access opening measurement - Inches (mm):

300	4 (102)	8.3966 (213)	12.792 (325)	17.188 (437)	21.584 (548)	25.980 (660)	30.375 (771)										
400	4 (102)	8.264 (210)	12.528 (318)	16.792 (426)	21.056 (535)	25.320 (643)	29.584 (751)	33.848 (860)	38.112 (968)	42.375 (1076)							
500	4 (102)	8.198 (208)	12.396 (315)	16.594 (421)	20.792 (528)	24.990 (635)	29.188 (741)	33.386 (848)	37.584 (955)	41.782 (1061)	45.980 (1168)	50.178 (1274)	54.375 (1381)				
600	4 (102)	8.158 (207)	12.316 (313)	16.474 (481)	20.632 (524)	24.790 (630)	28.948 (735)	33.106 (841)	37.264 (946)	41.422 (1052)	45.580 (1158)	49.738 (1263)	53.896 (1369)	58.054 (1475)	62.212 (1580)	66.375 (1686)	

Number of Readings:	Average Velocity of Constricted Area ft./min.(ms)
---------------------	--

1.		Average Velocity of Constricted Area	fpm (m/s)
2.	X	Constricted Access Area	ft <sup>2</sup> (m <sup>2</sup> )
3.	=	Constricted Area Volume	CFM(m <sup>3</sup> /s)
4.		<b>Constricted Area Volume</b>	CFM(m <sup>3</sup> /s)
5.	÷	10"(254) or 8" (203) or 12" (305mm) Access Window Area	ft <sup>2</sup> (m <sup>2</sup> )
6.	=	Average Velocity of 10"(254) or 8" (203) or 12" (305mm) Access Window Area	fpm (m/s)
7.		<b>Average Velocity of 10"(254) or 8" (203) or 12" (305mm) Access Window Area</b>	fpm (m/s)
8.	X	Correction Factor for Window Height	
9.	=	Average Inflow Velocity	fpm (m/s)

d. Acceptance Criteria: Access Opening Inflow Velocity = 100 to 110 fpm (.51 to .56 m/s)

Areas/Correction Factors for Calculations

Cabinet Size	Window Access Opening				Correction Factor For		
	3" (76mm) Constricted	10" (254mm)	8" (203mm)	12" (305mm)	10" (254mm) Window	8"(203mm) Window	12"(305mm) Window
300	.72 (.067)	2.39 (.222)	1.91 (.177)	2.86 (.267)	1.01	1.0	1.0
400	.97 (.090)	3.22 (.299)	2.58 (.240)	3.86 (.358)	1.0	1.0	1.03
500	1.22 (.113)	4.05 (.376)	3.24 (.301)	4.86 (.451)	1.0	1.03	1.03
600	1.47 (.137)	4.89 (.454)	3.91 (.363)	5.86 (.544)	1.02	1.02	1.0

## 7.6 HEPA Filter Leak Test

In order to check filter and filter seal integrity, the HEPA filter media and seals must be directly accessible by the measuring instrument. The challenge material (i.e. PAO) should be supplied in the rear center of the workzone over the intake slots. The upstream challenge tubing/port being common for both filters is located under the work surface with a red cap.

### 7.6.1 Supply Filter

The diffuser plate, placed below the HEPA to protect the filter during normal usage, may be removed as follows: The diffuser is secured to the cabinet shell by #1/4-20 acorn nuts located immediately behind the front viewing window. After removing the fasteners, drop the front of the diffuser plate several inches and pull forward gently. Note that the diffuser is purposely a tight fit - it is held to the back wall of the cabinet interior by a light push - fit with projecting studs. To avoid the window high alarm during the filter integrity check, it is desirable to enter the Service menu and turn on the blower.

Air currents in the room can sometimes contribute to exhaust entrainment on top of the cabinet. This can lead to false leak readings. In order to reduce the probability of false leak readings, it is recommended to cover half of the exhaust HEPA filter while scanning the uncovered section of the exhaust HEPA filter.

### 7.6.2 Exhaust Filter

The exhaust filter is typically more difficult to check since protective grills, charcoal filters, or exhaust transitions could cover the filter. Access panels are usually provided and should be removed. If an air gap exhaust transition is provided, the air gap must be sealed with duct tape or other suitable means to prevent contaminated air from migrating into the exhaust efflux. All exhaust blowers/fans should be turned off during the check. The exhaust sensor shroud can also be removed for the exhaust filter integrity check. Replace the exhaust sensor shroud immediately after the filter check to assure proper operation.

 **NOTE:** To avoid the window high alarm during the filter integrity check, it is desirable to enter into the Service menu and turn the blower on. To accomplish this, perform the following:



3 key sequence.

The following service parameter display should appear

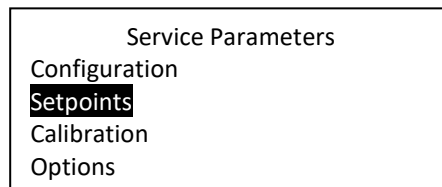

Navigation through the service parameter menu is the same as the operator menu.



 **Note:** If the upstream challenge port is deemed contaminated and not accessible, use both downflow and exhaust volume for determining challenge concentrations. Use following area information below with average downflow velocity and spot-check exhaust velocities as measured to determine volume (CFM) (CMH).

Model Size	*Supply Area (ft <sup>2</sup> )(m <sup>2</sup> )	Exhaust Area (ft <sup>2</sup> )(m <sup>2</sup> )	Model Size	*Supply Area (ft <sup>2</sup> )(m <sup>2</sup> )	Exhaust Area (ft <sup>2</sup> )(m <sup>2</sup> )
300	6.33 (.588)	1.61 (.150)	500	10.74 (.998)	4.17 (.387)
400	8.53 (.792)	3.06 (.284)	600	12.95 (1.203)	5.00 (.465)

\* Measured 4 inches above the bottom edge of the window.

#### Laskin Nozzle Concentration Formula

$$\frac{\# \text{ Nozzles} \times 135 \text{ CFM} \times 100 \text{ ug/L}}{\text{Downflow (CFM)} + \text{Exhaust (CFM)}} = \text{Challenge Concentration (ug/L)}$$

$$\frac{\# \text{ Nozzles} \times 229 \text{ CMH} \times 100 \text{ ug/L}}{\text{Downflow (CMH)} + \text{Exhaust (CMH)}} = \text{Challenge Concentration (ug/L)}$$

### 7.7 Airflow Smoke Pattern Test

The airflow smoke pattern test is performed using a smoke source (i.e. smoke tubes) in and around the cabinet workzone and access opening to determine a visual representation of the cabinet's containment performance. To perform the test, the smoke source should be passed through the following areas:

A smoke source shall be passed:

1. From one end of the cabinet to the other, along the center line of the work surface, at a height of 4 inches (102mm) above the top of the access opening.
2. From one end of the cabinet to the other, 1 inch (25mm) just inside the view screen, at a height 6 inches (152mm) above the top of the access opening.
3. Along the edges of the entire perimeter of the work opening approximately 1.5 inches (38mm) outside the cabinet, with particular attention paid to corners and vertical edges.
4. 2 inches (51mm) from the sides up inside of the window at the side channel seals, and along inside of the cabinet along the top of the work area or immediately below the wiper gasket.

The criteria used to evaluate the smoke patterns is the following:

1. The smoke inside the cabinet shall show smooth downward flow with no dead spots or reflux.
2. No smoke shall escape from inside the cabinet.
3. No smoke refluxes out of the cabinet once drawn in, nor does smoke billow over the worksurface or penetrate onto it.
4. No smoke shall escape from the cabinet.

### 7.8 Site Installation Assessment Tests

These tests are performed to verify the sash position, airflow or pressure setpoint where an audible and/or visual alarm will activate to signify unfavorable operating conditions within the Biosafety cabinet and/or the remote exhaust blower, and canopy connection performance.

#### 7.8.1 Sash Alarm

- Step 1: With sash alarm switch enabled, raise the sliding sash 1" (2.5cm) above the manufacturer's designated sash height for normal operation. Verify that the audible/visual alarm activates/sounds.
- Step 2: Return the sash to its normal operating height.

Note, if necessary, adjustment of the sash alarm switches can be accomplished by:

Behind the right side faring there is a cover panel that needs to be removed.

Then you can access the microswitches and adjust the trip point.

Adjustment is not just vertical, but as you see in the following picture, we have allowed tolerance for rotational adjustment too.

Sometimes how the window switch roller is positioned will affect its activation point.

Use a nut driver to loosen the switch plate, adjust and re-tighten.



### 7.8.2 Airflow or Pressure Alarm (when installed)

- Step 1: Measure and record the speed control operating voltage at the speed control test points using a voltmeter.
- Step 2: Using the primary or secondary inflow test method, lower the speed control voltage to reduce the inflow by 20% from the certified testing value.
- Step 3: Verify that the alarm activates when the inflow is dropped to this point.
- Step 4: Adjust alarm setpoint as necessary as instructed by the alarm manufacturer procedures.
- Step 5: Return the speed control to its certified operating voltage as measured by the voltmeter.

### 7.8.3 Exhaust System Performance

#### Canopy Exhaust Transitions

- Step 1: Introduce a visible medium source into the canopy air intake(s) while slowly reducing the exhaust volume until there is a loss of capture of the visible medium into the canopy air intake(s).  
The audible and visual canopy alarms shall respond within 15 seconds, and the cabinet fan(s) will continue to operate.
- Step 2: Return exhaust volume to original value.

 **NOTE:** Positive pressure ductwork conditions are strongly discouraged. Positive pressure ductwork conditions should be reviewed and evaluated by a cognizant Safety Officer of Industrial Hygienist as part of their Laboratory Ventilation Management Program and Chemical Hygiene Plan.

## 7.9 Cleanliness Classification Test for Pharmacy Application

If this cabinet is going to be used within pharmacy, per USP797<sup>1</sup>, the cabinet must be tested to assure compliance to ISO 14644-1:1999, Cleanrooms and Associated Controlled Environments, Part 1: Classification of Air Cleanliness<sup>2</sup>. The cleanliness classification test is performed using a particle counter to measure particle counts within the cabinet workzone. Turn on cabinet and let warm up for several minutes. Turn on particle counter and flush out sample tubing line to remove latent particles. Set the particle counter to measure 0.5 micron or larger particles at the appropriate measuring rate.

### “Operational Particle Count Test<sup>3</sup>”

Position the particle counter isokinetic probe at a point 6 inches (152mm) upstream of the aseptic manipulation area (hand convergence point) and mounted so as not to interfere with the operator’s hand movement. The pharmacy operator will simulate IV manipulation during the particle count test using non-hazardous materials. A minimum of three (3) 1-minute particle counts shall be sampled and recorded while the user simulates aseptic compounding manipulations.

### “At Rest Particle Count Test”

Take 5 test points in 1-minute intervals on a grid, in a horizontal plane as measured approximately 6 inches (152mm) above the worksurface. The grid location is designed as the workzone center point and each corner measured 6 inches (152mm) from the inside perimeter.

Record the 5 particle count values for each of the test points over the 1-minute sample time.

All final count particle concentrations and calculated 95% upper confidence limit shall not exceed 3520 particles per cubic meter (ppcm) or 100 particles per cubic feet (ppcf).

<sup>1</sup> USP28-NF23: United States Pharmacopeial Convention, Inc., 12601 Twinbrook Parkway, Rockville, MD 20852, USA, [www.usp.org](http://www.usp.org).

<sup>2</sup> ISO 14644-1:1999 Cleanrooms and Associated Controlled Environments-Classification of Air Cleanliness, International Organization for Standardization, Case Postale 56, CH-1211 Geneve 20, Switzerland

<sup>3</sup> CAG-002-2006: CETA Compounding Isolator Testing Guide, Controlled Environment Testing Association, 1500 Sunday Drive, Suite 102, Raleigh, NC 27607, USA, [www.cetainternational.org](http://www.cetainternational.org)

### 7.10 Main Control Board Description and Replacement

To access the main control board for fuse or board replacement, remove screws at each upper side of the control center and allow the control center to rotate down, resting on the safety straps. Now the main control board is exposed for service.

#### 7.10.1 Main Control Board Replacement

The main control board consists of one Printed Circuit Board (PCB) assembly.

The PCB contains the power supply, configuration switch, sensor inputs/outputs and control inputs/outputs components and display.

#### 7.10.2 Main Control Board Fuse Replacement



Disconnect electrical power from cabinet before fuse replacement.

All AC circuits are fuse protected and when replacement is necessary, USE ONLY FUSES OF SAME TYPE AND RATING FOR PROTECTION AGAINST RISK OF FIRE.

DESCRIPTION:	BLOWER FUSE	OUTLET FUSE	ACCESSORY OUTPUT FUSE	LIGHT FUSE
FUSE TYPE:	TIME-LAG	TIME-LAG	TIME-LAG	TIME-LAG
FUSE SIZE:	1/4 X 1-1/4 INCH	5 X 20MM	5 X 20MM	5 X 20MM
NU-543-300	10 AMPS	3 AMPS (2)	2 AMPS	1 AMP (2)
NU-543-400	12 AMPS	3 AMPS (2)	2 AMPS	1 AMP (2)
NU-543-500	15 AMPS	3 AMPS (2)	2 AMPS	1 AMP (2)
NU-543-600	15 AMPS	3 AMPS (2)	2 AMPS	1 AMP (2)

#### 7.10.3 Main Control Board Replacement

Note: All setup and calibration data will be lost, the memory reinitialized to the default values and all control functions reset to an initial cabinet power condition.

If possible, before the main control board replacement, it would be preferred to know the operational parameters of the cabinet, (i.e. blower speed/PWM signal DC voltage setpoints if modified and airflow data from previous certification).

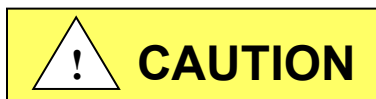

Disconnect electrical power from the cabinet before attempting any maintenance action.

The main control board is fastened to the control center with (6) 6-32 studs/nuts. All electrical connections are made with removable terminals and/or Faston connectors except for the motor/blower connector which uses a screw terminal. Remove all electrical connections and fasteners and then remove the main control board from the control center.

Install new main control board by reattaching all electrical connections and fasteners. Once installed, rotate control center to normal position and fasten in place.

Reconnect power to cabinet.

#### 7.10.4 FlowGard™ Control Board Reset

The FlowGard™ control board has a reset function available for Qualified Service Personnel.

Master Reset – Resets all calibration, cabinet size, motor type/function and option settings back to their default condition. It is recommended to perform a master reset upon installation of replacement control board or if there seems to be intermittent functional abnormalities.

Perform the following sequence to accomplish a master reset:

- 1) Turn off all functions i.e. blower, lights, etc.
- 2) Press and hold alarm silence key for 10 seconds until alarm LED flashes, then release.
- 3) Press hidden key within 5 seconds of the alarm LED flashing. There will be a (3) beep confirmation that the reset has occurred.
- 4) Turn off cabinet (either unplug cabinet or use power switch on left side within control panel) then turn back on to reinitialize the FlowGard™ control board. Just as in the initial power up, the RED alarm LED will blink to indicate power up status along with the display message of power on reset.

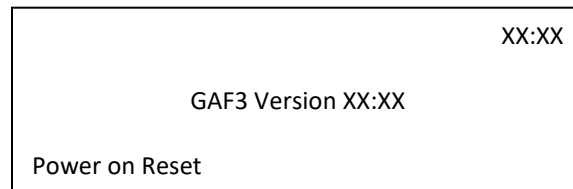

- 6) Enter into service parameters and input configuration, set points, calibration and option settings as required.

#### 7.11 Digital Intelliflow Airflow Sensor Description and Replacement

The airflow sensor function utilizes two thermistors that provide a constant current source. One thermistor is a reference that uses a very low current source. The other thermistor is the airflow measurer that uses a very high current source. As airflow passes over the thermistors, the airflow removes heat from the thermistor measuring airflow. The loss of heat from the thermistor causes the voltage from the thermistor to increase. This increased voltage subtracted from the reference thermistor output voltage is what directly relates to airflow velocity. A repeatable curve can be generated (voltage vs. airflow velocity).

The thermistors used are glass bead and coated and can be cleaned by gently using a cotton swab and alcohol. Formaldehyde gas, Hydrogen Peroxide and Chlorine Dioxide have no effect on the airflow sensors; however, the formaldehyde/Ammonium bicarbonate residue that remains after decontamination should be removed from the airflow sensor thermistors.

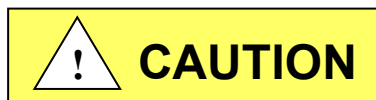

Disconnect electrical power from the cabinet before attempting any maintenance action.

The airflow sensor is removed by turning the locking ring counterclockwise and gently pulling the sensor away from the connector. To reattach the airflow sensor, turn sensor in keyed connector until key matches, push in and turn the locking ring clockwise until ring locks.

Once the new sensor has been replaced, airflow calibration (sensor value adjust for inflow velocity) is required.



## 8.0 Error Messages, Troubleshooting, Option-Diagnostics and Airflow Sensor Performance Verification

Audible alarms and error messages occur for a variety of reasons. Whenever an alarm condition has been present for a period of at least 10 seconds, the audible alarm/error message will be presented and stay on until the error is cleared. The audible alarm will be on for 30 seconds upon initial alarm condition, then once every ten seconds. When presented with an error message, please perform the following:

Step 1: NOTE ALL ERROR MESSAGES.

Error message will appear in message area on the display with the red alarm LED oval.

Step 2: VERIFY ERROR MESSAGES.

Error messages can be verified by clearing the error function by either turning the blower or the cabinet on and off.

Step 3: MONITOR RE-OCCURRENCE OF ERROR MESSAGES.

If re-occurrence of the error message is immediate or daily, use the following guide to correct the situation.

### 8.1 Error Message Troubleshooting Guide

Error Message	Indicator	Correction
- Window Alarm (Window High)	Sliding window is above standard working height or micro switch is not operating properly.	Verify standard working height and window micro switch operation.
- Window Alarm (Window Low) Window Closed	Sliding window is below standard working height or micro switch is not operating properly. Indicates the window is in the full down position	Verify standard working height and window micro switch operation.
- Velocity Alarm	Airflow went above or below alarm setpoints.	Check orientation of exhaust sensor shroud Check motor PWM signal. Recertify cabinet to proper airflow setpoints.
	Inflow airflow went above high alarm setpoint.	
Cabinet fluorescent lights won't turn on	Blue LED above light key indicates the lamp should be on.	Check light fuse on main control board. Check lamps. Check voltage coming out of main control board to light ballasts.
Cabinet blower won't turn on.	Green LED above blower key indicates the blower should be on. Airflow Alarm.	Check blower fuse on main control board. Check AC voltage coming out of main control board. Check wiring to blower. Check blower motor. Check DC motor PWM signal on main control board.
Power on reset	Indicates a power interruption has occurred.	Press any key to clear message.
Cabinet outlets won't turn on.	Blue LED above outlet key indicates the outlets should be on.	Check outlet fuse located on main control board. Check voltage coming out of main control board.
Cabinet ultraviolet light won't turn on.	Yellow LED above UV light key indicates the UV lamp should be on.	Check sliding window position- should be fully closed. Check blower/lights fuse on main control board. Check voltage coming out of the main control board to ultraviolet light ballast. Check light starters, if present. Check ballast.
Blower or light fuse continues to blow after replacement.	N/A	Check for short on output of fuse. Isolate output of fuse by disconnecting control center connectors, light circuit, AC or DC blower circuit, etc. to isolate the short.
Replace UV Light!	Indicates that the UV light needs replacement	Replace UV light and clear UV run time clock.
Nite Care On	Indicates that the Nite Care is activated, preventing the usage of the cabinet.	N/A
Velocity sensor comm error	Indicates a digital communications error from the main control board to the airflow sensors.	Check connectors and wires from main control board to the airflow sensors.
Velocity sensor error	Indicates an error signal generated by the sensor.	Check airflow probe connector on airflow sensor bd. Replace airflow sensor if required.
New firmware loaded	Message acknowledges new firmware was loaded into microprocessor	N/A
Blower rpm failure blinking Red Blower LED	Indicates that the motor rpm signal has been interrupted	Check connectors and wires from main control board to the motor Replace motor if required

## 8.2 Option Parameters

The option parameter menu allows **A QUALIFIED TECHNICIAN** to configure several different optional parameters per the menu below.

To enter the service parameter menu, perform the following:



3 key sequence.

The following service parameter display should appear

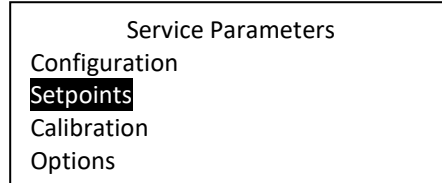

Navigation through the service parameter menu is the same as the operator menu.

- Press ↑ on ↓ keys to select a menu item which will be highlighted inversely. Menu selection moved in a round robin pattern.
- Press ENT key on a selected menu item will either:
  - 7) Drill further down the menu tree
  - 8) Allow editing of the item value which will now be highlighted.
    - Press ↑ or ↓ key to change the selected value
    - Press ENT key to accept the change



To enter the option parameter menu, you must first enter the service parameter menu.

Each parameter sub-menu will be described as well as the display will the default conditions as shown.

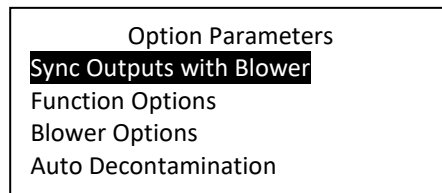

### 8.2.1 Sync Outputs with Active Blower

Sync outputs with active blower allows for the listed functions to be turned on and off automatically when the blower is actively running. If the blower is pending (blinking LED above blower switch), these listed functions will not turn on if selected as active. ONLY when the blower is actively running will these functions turn on.

Sync with Active Blower	
Fan Relay:	No
Fluorescent Light:	No
15 Volt DC Output	No
Accessory Outlet:	No
Outlet Power:	No

Fan Relay - Normally the fan relay will activate when the blower switch is pressed. Blower can either be actively running or pending. If the fan relay sync is active the blower must be actively running for the relay to change state.

Fluorescent Light – Normally the fluorescent light is turned on via the fluorescent light key. If the fluorescent light sync is active; the blower must be actively running for the fluorescent light to turn on.

15Volt DC Output – Normally the 15 Volt DC output located on the control board is on when power is applied to the FlowGard™ system. If the 15 volt DC output is active, the blower must be actively running for the 15 volt DC output to turn on.

Accessory Outlet – Normally the accessory outlet is on all the time. If the accessory outlet sync is active, the blower must be actively running for the accessory outlet to turn on.

Outlet Power – Normally the outlet power is turned on via the outlet key. If the outlet power sync is active, the blower must be actively running for the outlet power to turn on.

### 8.2.2 Function Options

Function Options	
Disable Intelliflow:	No
Allow UV Light Any time:	No
Alarm active in WarmUp:	No
Airflow Alarm Silence:	Yes

Disable Intelliflow – If this function is active. All airflow display and alarm functions are turned off.

Allow UV light anytime – Normally the UV light is interlocked with the window being in the closed position. For service purposes only, if this function is active, the UV light may be turned on at any window height.

 **Note:** IN addition to the Allow UV light anytime system function, there is a double redundant UV light window interlock relay. To override the UV light window interlock relay, the relay itself must also be shorted (see electrical schematic for reference).

Alarm Active in Warm Up – Normally the audible and visual alarm is not active during the blower warm up period. If this function is active, both an audible and visual alarm will occur during the blower warm up period. The audible alarm may be silenced, but the visual alarm will remain active until the warm up period is complete.

Airflow Alarm Silence – Normally airflow alarms that occur can be temporarily silenced (i.e. default audible silence time is 15 minutes) by pressing the alarm silence key. If this function is turned off, the audible alarm cannot be silenced.

### 8.2.3 Blower Options

Blower Options	
Nite Care Enabled:	No
Auto Blower Restart:	Yes
Require Password:	No
Blower Running Hours:	6234

Nite Care – Normally the Nite Care function is turned off. If selected and turned on, once the blower is actively running. Upon window closure, the blower will continue to run at a calibrated lower speed level to keep the workzone interior sterile. The display will indicate Nite Care on and green LED above blower key will blink. The fluorescent light will turn off (blue LED above light key will blink if window closure turned it off) and become inoperable; however the UV light can be used.

Auto Blower Restart – Normally when the blower is actively running and a power interruption occurs. The blower will automatically come back on when power is restored. If this function is turned off, the blower will not automatically come back after a power interruption, but would require the user to press the blower key to restart the blower.

Require Password – Normally it is not required to use a password (i.e. 3 keypress sequence of the blower and hidden key). If the option is turned on, it would be required to use the correct password to turn on the blower. The default password once turned on is (blow-hidden-blow keys in sequence). The password can be changed in the main menu.

Blower Running Hours – Blower running hours is the accumulated time the blower is actively running including Nite Care blower time.

### 8.2.4 Auto Decontamination

Auto decontamination is intended to be used with an automated decontamination system (i.e. Bioquell H<sub>2</sub>O<sub>2</sub> system, etc.) The intent is to be able to run the cabinet blower automatically during the automated decontamination cycle to improve the vapor/gas movement throughout the cabinet. The following FlowGard™ menus allow the cabinet to be sequenced with the automated decontamination system.

Auto Decontamination	
Total duration: (hh.mm)	3:00
Blower run time: (mm.ss)	1:00
Blower start schedule	
Initiate decon cycle	

- Total duration is the total automated decontamination cycle time, so both the cabinet Auto Decontamination time duration and the automated decontamination system cycle time are sequenced and run together.
- Blower run time is the length of time the blower will run during and of the (4) possible blower start times.
- Blower start schedule is the start time of (4) possible blower start times during the decon cycle.

Blower Start Time	
Start blower at:	1:00
Start blower at:	1:30
Start blower at:	2:00
Start blower at:	2:30

- Initiate decon cycle provides a short safety check list the must be answered yes before the decon cycle can be initiated.

Initiate Auto Decon	
Cabinet sealed:	No
Gas in/out connected:	No
Blower stopped:	No
Perform Auto Decon	

- Once the Auto Decon cycle is initiated, the following display indicates cycle progress until the times reach the end of their duration.

Auto Decon in Progress		
0:00	Next blower	1:00
	Finished in	3:00
Press Alarm silence to abort		

## 9.0 Remote Contacts

The NU-543 has several contact closures for remote sensing of various functions.

### 9.1 Fan Relay

The fan relay contacts are normally open and closed contact closure outputs that are activated whenever the blower key is pressed and the blower key LED indicator is on or blinking. Contact ratings are 250 VAC maximum at 2 Amps.

### 9.2 Alarm Relay

The alarm relay contacts are normally open and closed contact closure outputs which are activated whenever an airflow alarm condition occurs. Contact ratings are 250 VAC maximum at 2 Amps.

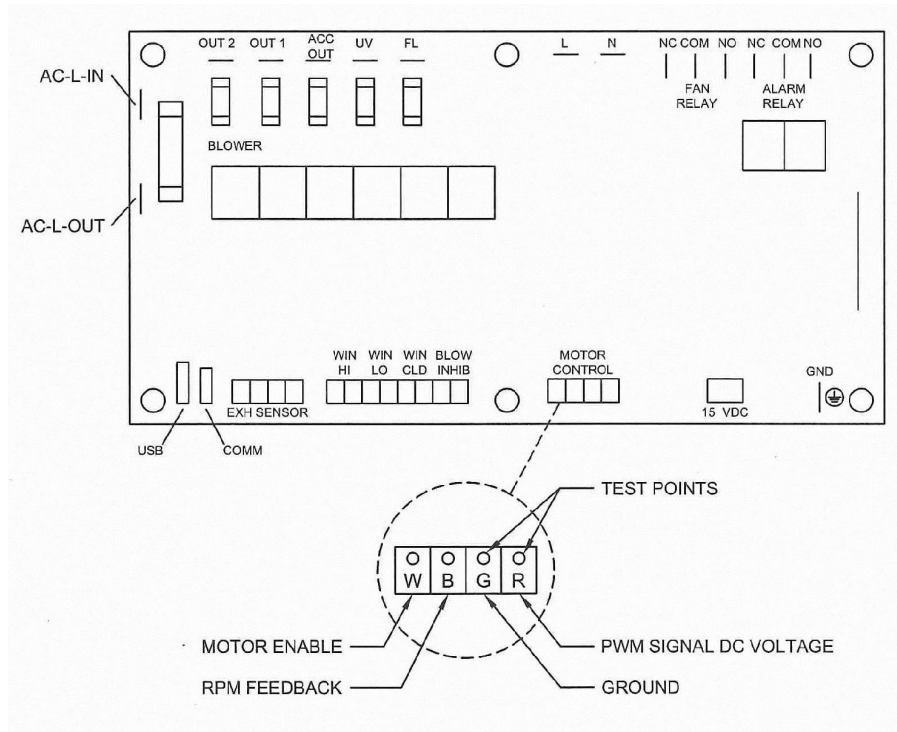

### 9.3 15VDC Output

The 15VDC (100mA) output is active when power is applied to the FlowGard™ control board.

## 10.0 Optional Equipment

### 10.1 Ultraviolet Light



Ultraviolet light will injure your eyes. Avoid direct viewing at all times. Personnel should not be present when ultraviolet lamp is on

#### 10.1.1 Overview

The germicidal ultraviolet is primarily intended for the destruction of bacteria and other microorganisms in the air or on directly exposed surfaces. Approximately 95% of the ultraviolet radiations from germicidal tubes are in the 253.7 nanometer region. This is a region in the ultraviolet spectrum which is near the peak of germicidal effectiveness. The exposure necessary to kill bacteria is the product of time and intensity. High intensities for a short period of time, or low intensities for a longer period are fundamentally equal in lethal dosage on bacteria (disregarding the life cycle of bacteria). The intensity of light falling on a given area is governed by the inverse law; that is the killing intensity decreases as the distance increases from the tube.

The germicidal tube is placed in the cabinet to provide an average intensity of 100 microwatts per centimeter (for a new tube) falling on a horizontal plane defined by the bottom of the work surface. The minimum requirement per paragraph 5.12 of NSF Standard 49 is 40 microwatts per square centimeter (ref. NSF Std. #49, June, 1976).

Since ultraviolet rays will not penetrate ordinary glass, it is recommended that the sliding window be closed while the ultraviolet light is on within the cabinet; or that personnel leave the cabinet face area.

#### 10.1.2 Operation

The operation of the ultraviolet light is accomplished by closing the sliding window and pressing the UV switch located on the front panel. The sliding window is interlocked to the ultraviolet light so, when the sliding window is raised, the ultraviolet light will turn off. If operational time duration is known, the timer can be used in conjunction with the ultraviolet light to time out the ultraviolet light operation. This can be accomplished by first turning on the ultraviolet light. Then, set the timer to the desired length of ultraviolet light operation time. Upon timer expiration, the ultraviolet light will turn off.

#### 10.1.3 Precaution

The rays from germicidal tubes may cause a painful but temporary irritation of the eyes and reddening of the skin, if of sufficiently high intensity, or if exposure covers a prolonged period of time. For this reason, one should avoid direct eye and skin exposure to ultraviolet light. If exposure cannot be avoided, it is necessary for personnel to wear eye goggles or face shields, and long sleeve gowns with rubber gloves.

Since ultraviolet rays will not penetrate ordinary glass, it is recommended that the sliding window be closed while the ultraviolet light is on within the cabinet; or that personnel leave the cabinet face area.

#### 10.1.4 Maintenance

The output of an ultraviolet light deteriorates with burning age. The useful life of the light is approximately 5000 hours under specific test conditions.

 **Note:** Before testing with lamp off, the light may be cleaned with a lint-free cloth dampened with alcohol or ammonia and water.

The control system monitors UV light usage hour and when the 5000 hour point is reached. The UV light LED indicator will blink fast along with the display message "Replace UV light". To view hours or reset timer, perform the following:

- Press and hold ENT key for 3 seconds until the menu appears.

Main Menu	
Time Menu	
UV Lamp Hours	3356
Temperature	75.0
Blower On/Off Password	none

- Press ↑ or ↓ keys to select UV lamp hours.
- Press ENT key to highlight hours.  
Press ↑ or ↓ key simultaneous until hours zero.
- Press ENT key to accept cleared hours.





Energies Required to Destroy Some Microorganisms by Ultraviolet Radiation (e)

Mold Spores	Microwatt seconds per cm/2	Protozoa	Microwatt seconds per cm/2
Penicillium roqueforti	26,400	Paramecium	200,000(a)
Penicillium expansum	22,000		
Penicillium digitatum	88,000	Nematode Eggs	40,000(b)
Aspergillus glaucus	88,000		
Aspergillus flavus	99,000	Algae	22,000(c)
Aspergillus niger	330,000		
Rhizopus nigricans	220,000	Virus	
Mucor racemosus A	35,200	Bacteriophage (E. Coli)	6,600
Mucor racemosus B	35,200	Tobacco Mosaic	440,000
Oospora lactis	11,000	Influenza	3,400(d)
Yeasts			
Saccharomyces	13,200		
ellipsoideus	17,600		
Saccharomyces cerevisiae	13,200		
Brewers' yeast	6,600		
Baker's yeast	8,800		
Common yeast cake	13,200		
Bacteria			
Streptococcus lactis	8,800		
Strep. hemolyticus (alpha type)	5,500		
Staphylococcus aureus	6,600		
Staphylococcus albus	5,720		
Micrococcus sphaeroides	15,400		
Sarcina lutea	26,400		
Pseudomonas fluorescens	7,040		
Escherichia coli	7,040		
Proteus vulgaris	7,480		
Serratia marcescens	6,160		
Bacillus subtilis	11,000		
Bacillus subtilis spores	22,000		
Spirillum rubrum	6,160		

References:

- (a) Luckiesh, Matthew (1946) Application of Germicidal, Ethymal and Infrared Energy, D. Van Nostrand o., New York, New York, pp 253
- (b) Hollaender (1942) Aerobiology, A.A.A.S. (for 90% inactivation), pp 162
- (c) Ellis, C. and Wells, O.O. (1941) The Chemical Action of Ultraviolet Rays, Reinhold Publishing Corp., pp. 713-714
- (d) Hollaender, A., Oliphant, J.W. (1944)  
The inactivation effect of monochromatic ultraviolet. Radiation on Influenza Virus (for 90% inactivation) Jour. of Bact. 48, pp. 447-454
- (e) This table, "Energies Required to Destroy Some Microorganisms by Ultraviolet Radiation's" comes from Westinghouse brochure entitled - "Westinghouse Sterilamp Germicidal Ultraviolet Tubes"

## 11.0 Electrical/Environmental Requirements

### 11.1 Electrical (Supply Voltage Fluctuations Not to Exceed +/- 10%)

*NU-543-300	115 VAC,	60 Hz,	1 Phase,	10 Amps
*NU-543-400	115 VAC,	60 Hz,	1 Phase,	14 Amps
*NU-543-500	115 VAC,	60 Hz,	1 Phase,	16 Amps
*NU-543-600	115 VAC,	60 Hz,	1 Phase,	16 Amps

\*UL/UL-C Listed

### 11.2 Operational Performance (for indoor use only)

Environment Temperature Range:	60°F-85°F (15°C - 30°C)
Environment Humidity:	Maximum relative humidity 80% for temperatures up to 31°C decreasing linearly to 50% relative humidity at 40°C
Environment Altitude:	6562 Feet (2000M)

### 11.3 Light Exposure

Standard Fluorescent Lighting @ 150 ft. candles (1614 LUX) maximum intensity.

### 11.4 Installation Category: 2.0

Installation category (overvoltage category) defines the level of transient overvoltage which the instrument is designed to withstand safely. It depends on the nature of the electricity supply and its overvoltage protection means. For example, in CAT II, which is the category used for instruments in installations supplied from a supply comparable to public mains such as hospital and research laboratories and most industrial laboratories, the expected transient overvoltage is 2500 V for a 230 V supply and 1500 V for a 120 V supply.

### 11.5 Pollution Degree: 2.0

Pollution degree describes the amount of conductive pollution present in the operating environment. Pollution degree 2 assumes that normally only non-conductive pollution such as dust occurs with the exception of occasional conductivity caused by condensation.

### 11.6 Chemical Exposure

Chemical exposure should be limited to antibacterial surface disinfectants used for cleaning and disinfecting. **USE OF CHLORINATED OR HALOGEN MATERIALS IN THE CABINET MAY DAMAGE STAINLESS STEEL.** Equipment decontamination can be accomplished by non-condensing gas or vapor Paraformaldehyde, Hydrogen Peroxide or Chlorine Oxide following NSF/ANSI 49, Annex I-2 (formerly Annex G).

### 11.7 EMC Performance (classified for light industrial)

Emissions:	EN61326-1 (Class A)
Immunity:	EN61326-1 (Industrial electromagnetic environment)



Class A equipment is intended for use in an industrial environment. In the documentation for the user, a statement shall be included drawing attention to the fact that there may be potential difficulties in ensuring electromagnetic compatibility in other environments, due to conducted as well as radiated disturbances.

## 12.0 Disposal and Recycle

Cabinets that are no longer in use and are ready for disposal contain reusable materials. ALL components with the exception of the HEPA filters may be disposed and/or recycled after they are known to be properly disinfected.

 **Note:** Follow all local, state and federal guidelines for disposal of HEPA filter solid waste.



BIOHAZARD

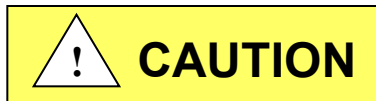

Prior to any disassembly for disposal, the cabinet must be decontaminated.



RECYCLE



LEAD FREE

<b>Component</b>	<b>Material</b>
Base Cabinet	Stainless Steel
Front Grill	Stainless Steel
Worksurface	Stainless Steel
Window Faring	Stainless Steel
Window Glides	HDPE
Window	Safety Glass
Window Frame	Stainless Steel
Front Service Panel	Painted Steel
Front Decorative Panel	Painted Steel
Control Center	Painted Steel
Supply Diffuser	Aluminum
Exhaust Filter	Aluminum
HEPA Filter Frames	Painted Steel
Hepex Bag	PVC
Blower Wheel and Housing	Steel
Motor	Various Steel
Printed Wiring Assembly	Lead Free Electronic
Wire	PVC Coated Copper
Ballasts	Various Steel, Electronic
Armrest	PVC
Connectors	Nylon
Hardware	Stainless Steel and Steel

 **Note:** Material type can be verified with use of a magnet with stainless and aluminum being non-magnetic.

REV	ECO	DESCRIPTION	DATE	DFTM	CHKD
E	13582	UPDATED HARDWARE	11/2/2018	TH	DSH

ITEM	QTY	PART NUMBER	DESCRIPTION
1	2	A-425-7373	Lateral Biosafety Cabinet Latch
2	8	A-500-395	Basestand Leg Bushing
3	2	B-500-386	Basestand End Panel Weldment
4	4	B-500-390	Basestand Leg Extension
5	1	B-500-391-TAB -01 -02 -03 -04	Cross Member Panel Weldment 3"
6	2	B-500-393	Front Mounting Bracket
7	2	B-500-394	Rear Mounting Bracket
8	4	X-980443	LEG LEVELER FOR Z' SQ TUBING
9	12	X-980493	Acorn Nut 1/4-20 (Low Crown) SST
10	8	X-990494-03	Acorn Nut 3/8-16 SST
11	8	X-980495	NuSert 1/4-20
12	2	X-980659-02	Bolt 3/8-16 X 3/4 SST
13	20	X-990659-12	Bolt HHCS 1/4-20 X 5/8 SST
14	10	X-980781-07	Lock Washer 3/8 Internal Tooth SST
15	18	X-980783-07	Washer 3/8 SAE Nickel
16	32	X-980794-02	Washer 1/4 SST
17	24	X-980815-01	Lock Washer 1/4 Internal Tooth SST
18	8	X-980929-01	Bolt 3/8-16 X 2-3/4 SST

ITEM	QTY	PART NUMBER	DESCRIPTION
16	17	13	E
17	13	16	E
18	13	17	E
19	13	16	E
20	13	17	E
21	13	16	E
22	13	17	E
23	13	16	E
24	13	17	E
25	13	16	E
26	13	17	E
27	13	16	E
28	13	17	E
29	13	16	E
30	13	17	E
31	13	16	E
32	13	17	E
33	13	16	E
34	13	17	E
35	13	16	E
36	13	17	E
37	13	16	E
38	13	17	E
39	13	16	E
40	13	17	E
41	13	16	E
42	13	17	E
43	13	16	E
44	13	17	E
45	13	16	E
46	13	17	E
47	13	16	E
48	13	17	E
49	13	16	E
50	13	17	E
51	13	16	E
52	13	17	E
53	13	16	E
54	13	17	E
55	13	16	E
56	13	17	E
57	13	16	E
58	13	17	E
59	13	16	E
60	13	17	E
61	13	16	E
62	13	17	E
63	13	16	E
64	13	17	E
65	13	16	E
66	13	17	E
67	13	16	E
68	13	17	E
69	13	16	E
70	13	17	E
71	13	16	E
72	13	17	E
73	13	16	E
74	13	17	E
75	13	16	E
76	13	17	E
77	13	16	E
78	13	17	E
79	13	16	E
80	13	17	E
81	13	16	E
82	13	17	E
83	13	16	E
84	13	17	E
85	13	16	E
86	13	17	E
87	13	16	E
88	13	17	E
89	13	16	E
90	13	17	E
91	13	16	E
92	13	17	E
93	13	16	E
94	13	17	E
95	13	16	E
96	13	17	E
97	13	16	E
98	13	17	E
99	13	16	E
100	13	17	E

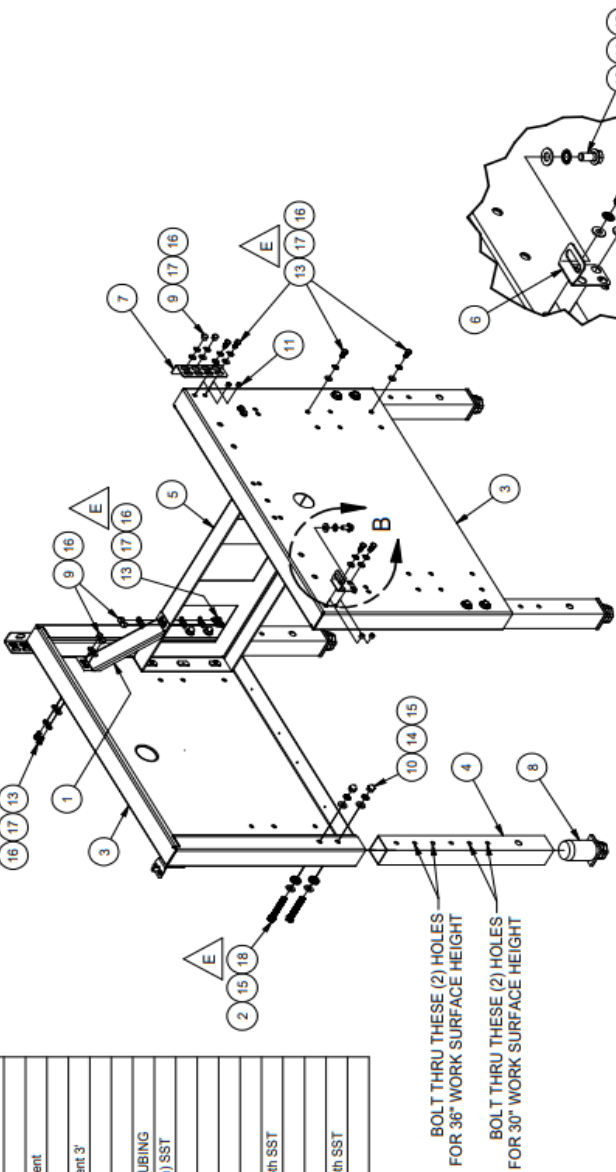

BOLT THRU THESE (2) HOLES  
FOR 36" WORK SURFACE HEIGHT

BOLT THRU THESE (2) HOLES  
FOR 30" WORK SURFACE HEIGHT

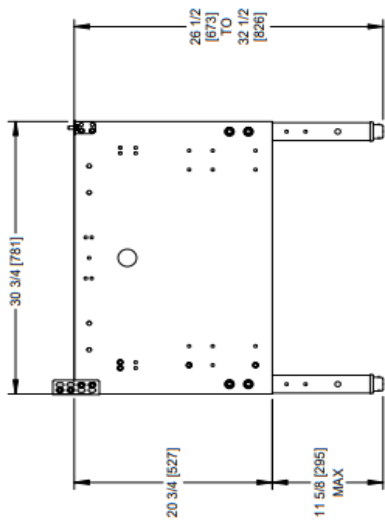
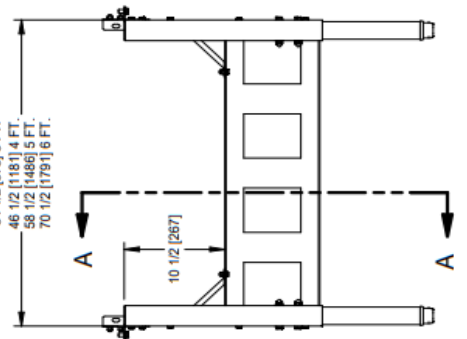
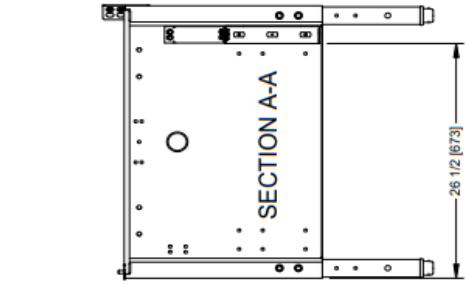
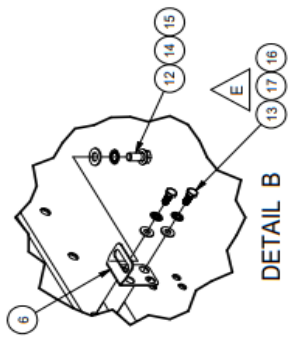

NU-475, 477, 480, 540, 543, 545, 560, 565
NU-500-100
NU-500-101
NU-500-102
NU-500-103



TITLE	ASSEMBLY 31"						
	TELESCOPING BASESTAND						
	W/ LL						
DFTM	DATE	CHKD	SHEET	1	OF	1	
LS	3/11/2014	Bp					
DRAWING	NUMBER					BCD-16633	E

REV	ECD	DESCRIPTION	DATE	DRAFT	CHKD
B	13471	ADDED NU-677	8/18/2017	TH	BP

CONTROL CENTER REMOVAL PROCEDURE

CAUTION

DISCONNECT ALL ELECTRICAL SERVICE TO UNIT BEFORE STARTING PROCEDURE

- 1A.) REMOVE (2) #8-32 SCREWS FROM TOP OF CONTROL CENTER AND GENTLY LET CONTROL CENTER OPEN ON SAFETY STRAPS.
- 2A.) REMOVE MINIHILIC GAUGE HOSE (IF PRESENT) (HOSE CLAMP/MAG GAUGE).
- 3A.) DISCONNECT ELECTRICAL CONNECTORS AND CABLE CLAMPS SO THEY ARE LOOSE TO THE MAIN CABINET (BOTH SIDES).
- 4A.) REMOVE A 1/4-20 NUT FROM CONTROL CENTER HOLDING THE SAFETY STRAP (BOTH ENDS)
- 5A.) LIFT CONTROL CENTER AND PULL UP AND AWAY. THE ABOVE STEPS.

FRONT DECORATIVE PANEL REMOVAL PROCEDURE

- 1A.) REMOVE (2) #8-32 SCREWS FROM TOP OF CONTROL CENTER AND GENTLY LET CONTROL CENTER OPEN ON SAFETY STRAPS.
- 1B.) REMOVE (3) NUTS FROM TOP EDGE OF PANEL.
- 2B.) REMOVE (6) KNURLED SCREWS FROM FRONT OF PANEL, IF PRESENT.
- 3B.) TO ATTACH FRONT DECORATIVE PANEL REVERSE THE ABOVE STEPS.

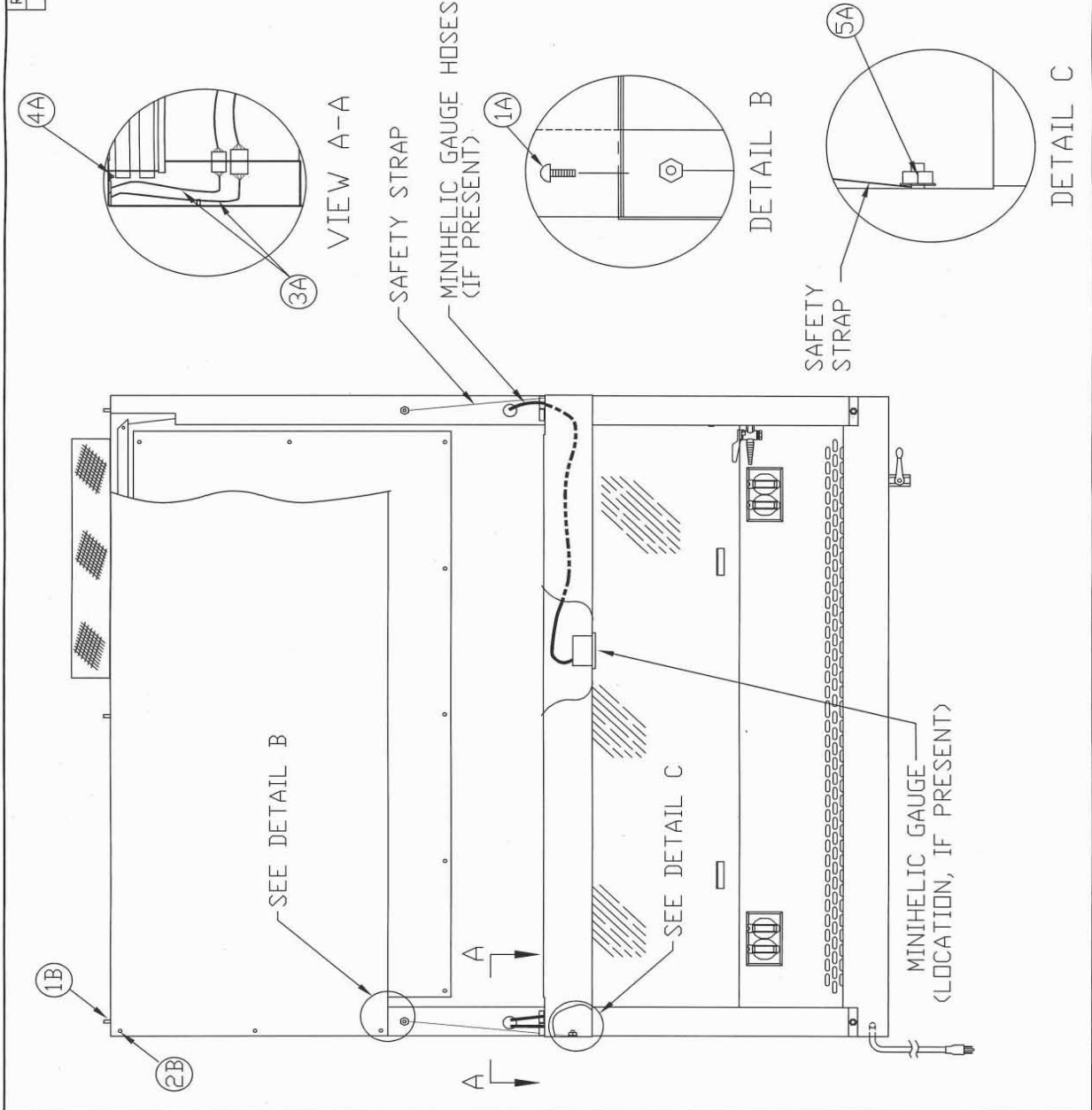



		<b>ORIGINAL</b>
NU-540 / 543 / 545 / 677 CONTROL CENTER & FRONT DECORATIVE PANEL		
DFTM/LS	9/12/13	CHKD/ BP
DRAWING NUMBER	BCD-16301	
		B

REV	ECO	DESCRIPTION	DATE	DRAFT	CHKD
C	13471	ADDED NU-677	8/18/2017	TH	BP

WINDOW GLIDE ADJUSTMENT

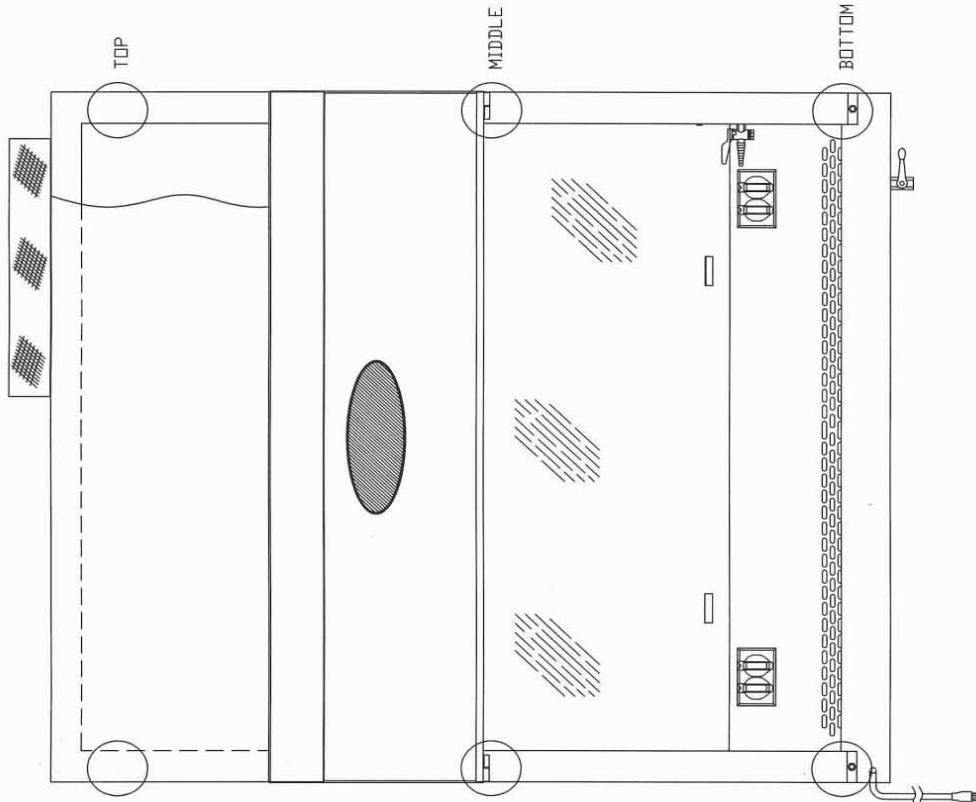
1. WINDOW GLIDE ADJUSTMENT IS ACCOMPLISHED BY MOVING THE RIGHT OR LEFT WINDOW FARING ASSEMBLY. ADJUSTING OR MOVING EITHER WINDOW FARING ASSEMBLY IN OR OUT WILL PROVIDE MORE OR LESS FRICTION ON THE SLIDING WINDOW AS DESIRED.
2. THE WINDOW ASSEMBLY IS LOOSENEED BY (3) 1/4-20 NUTS (BOTTOM, MIDDLE (BEHIND THE CONTROL CENTER) AND TOP (BEHIND DECORATIVE PANEL)) AS INDICATED ON THE ILLUSTRATION.
3. ONCE ADJUSTMENT IS COMPLETE, VERIFY WINDOW SWITCHES STILL MAKE CONTACT THROUGH THE FULL SLIDING WINDOW RANGE.  
 WINDOW HIGH SWITCH - ALARM  
 WINDOW CLOSED SWITCH - BLOWER OFF OR NITE CARE  
 WINDOW LOW SWITCH - ALARM



		<b>ORIGINAL</b>	
NU-540 / 543 / 550 / 560 / 565 / 677		SLIDING WINDOW ASSY & ADJUSTMENT	
DFTM	LS	9/12/13	CHKD
DRAWING NUMBER		BCD-16376	
		SHEET 1 OF 1	
		<b>C</b>	

REV	ECD	DESCRIPTION	DATE	DRAFT	CHKD
B	13471	ADDED NU-677	8/18/2017	TH	BP

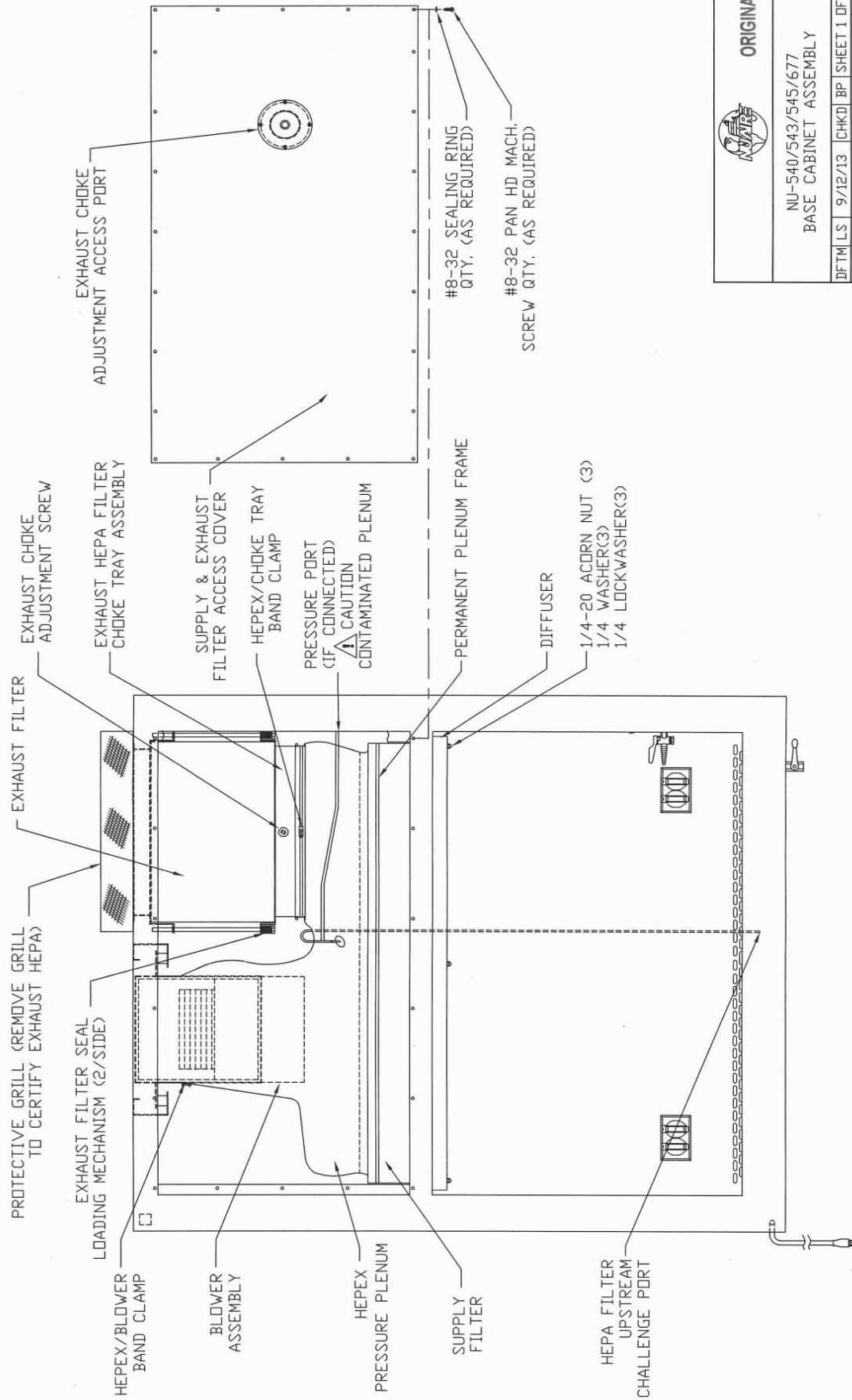

ORIGINAL	
NU-540/543/545/677 BASE CABINET ASSEMBLY	
DFTM/LS	9/12/13
DRAWING NUMBER	BCD-16299
	SHEET 1 OF 1
	B

