

NUWIND CENTRIFUGE

Models NU-C200V
NU-C200R
NU-C200V-E
NU-C200R-E

Operation & Maintenance Manual

May, 2020
Revision 11



(230 VAC, 50 Hz)

Manufactured by:
NuAire, Inc.
2100 Fernbrook Lane
Plymouth, Minnesota USA 55447
Toll Free: 1-800-328-3352
In MN: 763-553-1270
Fax: 763-553-0459

You have just purchased one of the finest Laboratory Centrifuges available. With proper care, maintenance and laboratory procedure, this centrifuge will provide you years of productive service. Please read this manual carefully to familiarize you with proper installation, maintenance and operation of the centrifuge. Other reference and guideline materials are available on our website, www.nuaire.com.

NUWIND Centrifuge

TABLE OF CONTENTS

Section No. 1	General Information
Section No. 2	Models Specifications and Accessories
Section No. 3	Shipments
Section No. 4	Installation Instructions
4.1	Location
4.2	Set-up Instructions
4.3	Certification Testing Methods and Equipment
Section No. 5	Operating the NU-C200
5.1	First Start / Powering
5.2	Operation / Interaction
Section No. 6	General Maintenance
Section No. 7	Error Messages, Troubleshooting, Option-Diagnostics & Performance Verification
Section No. 8	Electrical/Environmental Requirements
Section No. 9	Disposal and Recycle
Compliance Certificate	Declaration of Conformity
Annex 1.0	Theoretical Basics of Centrifugation
Annex 2.0	Accessory Specifications

ELECTRICAL SCHEMATICS

BCD-17000	NU-C200V / NU-C200V-E
BCD-17001	NU-C200R / NU-C200R-E

NUWIND Centrifuge

1.0 General Information

1.1 Description

The NUWIND 2.0 is a laboratory benchtop series of centrifuges that maximizes productivity while minimizing laboratory required bench space. The centrifuge functionality allows the separation of substances of different densities held in suspension or emulsion in a liquid using centrifugal force.

The NUWIND 2.0 centrifuge is available in two models, one ventilated and the other refrigerated.

The NU-C200V ventilated model has a unique ventilation system to maximize performance within laboratory ambient temperature conditions.

The NU-C200R refrigerated model adds precise temperature control to further maximize performance.

The refrigeration system refrigerant used is CFC-free to meet regulations of refrigerant use.

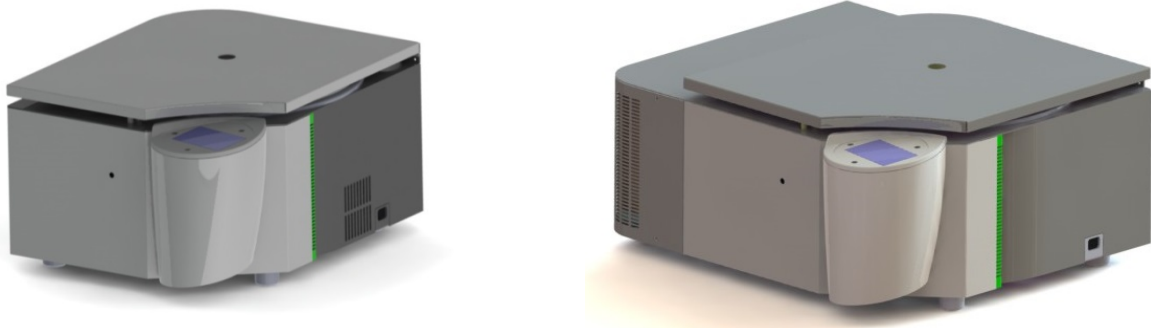

Centrifuges NUWIND 2.0: ventilated and refrigerated models

Intended use

The centrifuge is designed and manufactured for use with rotating accessories supplied by NuAire, Inc. It is suitable for separating substances of different densities held in suspension, or emulsion in a liquid.

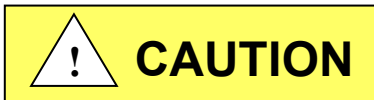

The maximum density of substances should be 1.2 g/ml.

The centrifuge must be used in an optimal state of operation and maintenance. The non-observance of the rule of use may threaten the health of users or third persons, but it may also cause damages to the unit and/or surrounding equipment.

Users of the equipment must be trained on good centrifugation practices, as well specific usage of the NUWIND models and Accessories. Any use outside the framework defined above is considered non-compliant.

NuAire, Inc. assumes no responsibility for injury due to improper use.

1.2 Safety Instructions

The operator must observe the following precautions when using the centrifuge:

- Ensure stability and perfect levelling of the centrifuge.
- Check the correct mounting of the rotor and its accessories before starting a centrifugation cycle.
- Check tube resistance at maximum applied centrifugal force: chemical resistance to centrifuged products and mechanical strength at the centrifugal force applied thereto.
- Check the condition of the tubes and remove damaged tubes.
- Use only the rotors and accessories authorized by the manufacturer NuAire, Inc.
- Swing-out rotors: install four (or two) buckets; never perform any cycle with missing buckets.
- Maintain and control accessories.
- Balance the load of the rotor around the axis of rotation.
- Respect the **maximum density of 1.2 g / ml**, in particular in case of a cycle at full speed.
- Limit volume in case of excess density.
- Install the centrifuge in a ventilated area, on a horizontal rigid support to absorb the vibrations generated by the centrifuge.
- During operation, the centrifuge must not be moved or be subject to impact.
- Do not attempt to open the lid while the rotor is spinning.
- Do not attempt to neutralize the motorized lid lock
- Do not lean over the centrifuge during the spin cycle.
- Do not stay within a space of 10 inch around the centrifuge longer than necessary.
- Do not leave potentially dangerous materials inside the free space.
- Use aerosol-barrier accessories when centrifuging bio hazardous material.
- Condensation may form inside the centrifuge when it is moved from a cold environment to a warm environment. Allow the centrifuge to warm up for two hours before use.

Prohibitions:

The centrifuge is not designed for the following uses and environments.

The following are prohibited:

- Flammable, explosive, toxic and radioactive materials
- Materials which may react, causing a hazard
- Contaminated materials not contained in an aerosol-barrier container
- Rotating rotors and accessories that have exceeded their maximum use.
- Rotating rotors and accessories that are not maintained according to the instructions in this manual, or showing signs of wear and/or corrosion.
- Rotating rotors and accessories not supplied by NuAire, Inc.



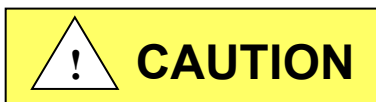





- Explosive environments
- Radioactive environments



Only operate a centrifuge after taking all necessary safety measures.

Rotors and buckets should be removed from use in case of mechanical fault trace, or corrosion. These elements have a life cycle duration, engraved on their visible part: To maintain safe conditions, it is imperative to replace them when the recommended duration is reached.

1.3 Explanation of Symbols

	<p>Safety alert symbol indicates a potentially hazardous situation which, if not avoided, could result in death or serious injury</p>
	<p>CAUTION used without the safety alert symbol indicates a potentially hazardous situation which, if not avoided, may result in property damage.</p>
	<p>Safety alert symbol indicates a potentially hazardous situation which, if not avoided, may result in minor or moderate injury.</p>
	<p>Pinching: This warning symbol indicates the presence of a risk of pinching when handling the lid.</p>
	<p>Used for important information</p>
	<p>Potential electrical hazard, only qualified person to access</p>
	<p>Biohazard</p>
	<p>Ground, Earth</p>
	<p>Lead Free</p>

2.0 Models, Specifications and Accessories

2.1 Specifications

Description	Laboratory Centrifuge			
Environmental Conditions	For indoor use only Environment Temperature Range: : 60°F - 85°F (15°C - 30°C) Environment Humidity: Maximum relative humidity 80% for temperatures up to 31°C decreasing linearly to 50% relative humidity at 40°C Environment Altitude: 6562 Feet (2000 meters) above sea level			
Maximum capacity	4x625 ml x kg / bucket, 4 x buckets			
Models	Ventilated		Refrigerated	
Catalogue Numbers	NU-C200V	NU-C200V-E	NU-C200R	NU-C200R-E
Supply Voltage (Depending on the model)	115 V ± 10% 60 Hz	230 V ± 10% 50Hz	115 V ± 10% 60 Hz	230 V ± 10% 50Hz
Nominal intensity (A)	8.5 A	4 A	17 A	8.5 A
Maximum Speed (rpm)	15,300 rpm (Depending upon the rotor)		18,000 rpm (Depending upon the rotor)	
Maximum Relative Centrifugal Force (g)	22,380 xg		30,980 xg	
Total Power Consumed	750 Watt		1600 Watt	
Dissipated Heat (Btuh) (1 Btuh = 0.29307 W)	3071 Btuh		6824 Btuh	
Fluid Coolant / Charge	Not applicable		R404A / 0.35 kg	
Ambient Operating Temperature	20°C ± 2°C		20°C ± 2°C	
Temperature adjustment range	N/A		-10 ° C to 40 ° C	
Temperature control precision	N/A		± 2 ° C	
Dimensions on bench (H x W x D)	347x457x604 mm 13.7 x 18.1 x 22 inches		322 x 675 x 582 mm 12.7 x26.7 x23 inches	
Net weight (excluding rotor)	71 kg /156 lbs.		110 kg / 242lbs.	
Packing (H x W x D) / Weight	500x600x800 mm 19.8 x 23.8 x 31.7 / inches 87 kg / 191 lbs.		500x800x800 mm 19.8 x 31.7 x 31.7 inches 126 kg / 277 lbs.	
Maximum sound level	≤ 60 dB(A)		≤ 55 dB(A)	
Integrated systems	Imbalance detection sensor Motorized lid lock Rotor speed control		Imbalance detection sensor Motorized lid lock Rotor speed control	
Control System	Microprocessor		Microprocessor	
Acceleration slopes	9		9	
Braking slopes	10		10	
Speed control precision	± 10 rpm		± 10 rpm	
Number of programs	99		99 + Pre-cooling + Pre-warming	
Optimal settings refrigeration	N/A		+4 ° C temperature with NU-RX500 rotor can be maintained at 4,200RPM at an ambient temperature of 20°C ± 2°C.	

2.2 Accessories

References	Description	Lot
NU-RX625	Swing-Out rotor 4x 625 ml (2 liters)	One unit
NU-B625	625 ml buckets	Set of 4
NU-L625	Lid 625 ml	Set of 4
NU-2T2	1,5 - 2mL MicroTube	Set of 2 or 4
NU-2T5	Tube insert 23x 5 ml	Set of 2 or 4
NU-2T10	Tube insert 19x 10/15 ml	Set of 2 or 4
NU-2T15C	Conical tube insert 11 x 15 ml	Set of 2 or 4
NU-2T50CL	Conical tube insert 4 x 50 ml	Set of 2 or 4
NU-2T50C*	Conical tube insert 5 x 50 ml	Set of 2 or 4
NU-2T50S	Self-standing conical tube insert 5 x 50 ml	Set of 2 or 4
NU-2T100	Round bottom bottle insert 1x 100 ml	Set of 2 or 4
NU-2T200	175/225* ml Conical Bottle	Set of 2 or 4
NU-2T265	Flat bottom bottle 1x 625mL	Set of 2 or 4
NU-BXDW	Microplate Bucket X	Set of 2 or 4
NU-RHDW	Microplate Rotor H	One unit
NU-BHDW	Microplate Bucket H	Set of 2
NU-LH	Biosafety secured lid for BHDW	Set of 2
NU-RX400	Swing-Out rotor 4x 400 ml (1 liter)	One unit
NU-B400	400 ml bucket	Set of 4
NU-L400	Lid 400 ml	Set of 4
NU-1T2	1,5 - 2mL MicroTube	Set of 2 or 4
NU-1T5	Tube insert 15x 7 ml	Set of 2 or 4
NU-1T10	Tube insert 12x 10 ml	Set of 2 or 4
NU-1T15C	Conical tube insert 7x 15 ml	Set of 2 or 4
NU-1T50C	Conical tube insert 3 x 50 ml	Set of 2 or 4
NU-1T50S	Self-standing conical tube insert 3 x 50 ml	Set of 2 or 4
NU-1T100	Round bottom bottle insert 1x 100 ml	Set of 2 or 4
NU-1T200	Round bottom bottle insert 1x 200 ml	Set of 2 or 4
NU-RA24-2	24x 2 ml 45° angle rotor	One unit
NU-RA30-2	30x 2 ml 45° angle rotor	One unit
NU-RA48-2	48x 2 ml 45° angle rotor	One unit
NU-RA16-5	16x 5 ml 45° angle rotor	One unit
NU-RA8-50	8x 50 ml 25° angle rotor	One unit
NU-RA6-100	6x 100 ml 28° angle rotor	One unit
NU-RA16-5	16x 5 ml Angle rotor	One unit
NU-RA30-15	30x 15 ml Angle rotor	One unit
(*) these inserts cannot be used with Bio-containment lids		

3.0 Shipments

NuAire takes every reasonable precaution to assure that your NUWIND Centrifuge arrives without damage. Motor carriers are carefully selected and shipping cartons have been specially designed to insure your purchase. However, damage can occur in any shipment and the following outlines the steps you should take on receipt of a NuAire NUWIND Centrifuge to be sure that if damage has occurred, the proper claims and actions are taken immediately.

3.1 Damaged Shipments

- 3.1.1** Terms are factory, unless stated otherwise. Therefore, it is important to check each shipment before acceptance.
- 3.1.2** If there is visible damage, the material can be accepted after the driver makes a notation on the consignee's copy of the freight bill. Then an inspection must be made to verify the claim against the carrier. This inspection is the basis of your filing the claim against the carrier.
- 3.1.3** If concealed damage is found it is absolutely necessary to NOTIFY THE FREIGHT AGENT AT ONCE and request an inspection. Without this inspection, the transportation company may not accept a claim for loss or damage. If the carrier will not perform the inspection, an affidavit must be prepared stating that he was contacted on a certain date and that he failed to comply with the request. This along with other papers in the customer's possession will support the claim.

4.0 Installation Instructions

4.1 Handling and transport

The package containing the centrifuge needs to be handled by suitable means (pallet truck, etc.). Please ensure that the people in charge of handling are qualified to handle the lifting equipment.



Maintain the following conditions during transport:

- Temperature: -20 to 50 ° C
- Relative humidity: <90%, under the dew point

4.2 Unpacking

Remove the cardboard packaging made of 2 parts (a lid and a bottom).

The NUWIND centrifuge was packed with great care to prevent transport hazards. Before disposing of the packaging of the centrifuge, and its spinning accessories, please make sure you are in possession of the following:

4.2.1 Packing list

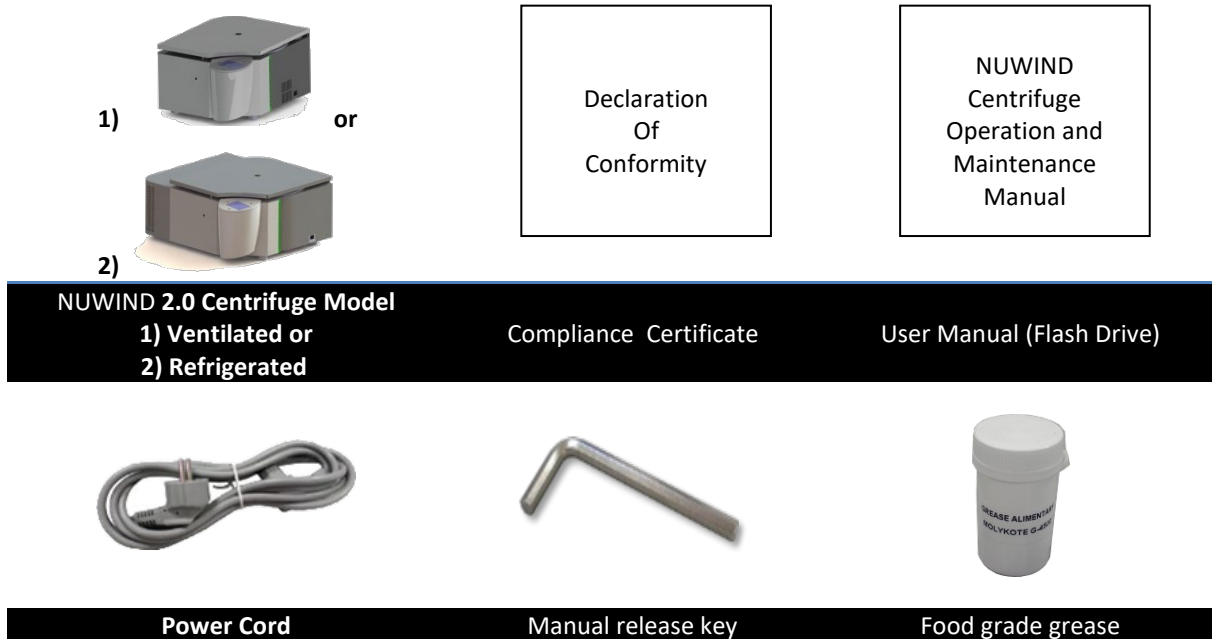

4.2.2 Preparation of rotor and accessories

The rotor and the 4 buckets may have been packed inside the centrifuge in order to reduce the volume of packing material. However, before any utilization, make sure to remove the packing foam before turning the unit on for the first time.

These packing foams allow the rotor to be centered inside the bowl without any constraint or forces applied directly on the motor shaft or without damaging any internal part in the bowl.

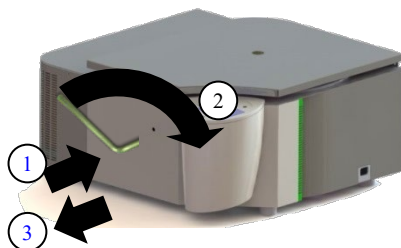

1. Insert the allen wrench in the hole on the front panel to manually open the centrifuge
2. Turn it clockwise until the lid opens up
3. Remove the allen wrench from the hole
4. Remove all the packing foam inside the bowl
5. Remove the buckets and put them on a table next to the centrifuge
6. Remove the rotor with both hands and put it on a table (it shouldn't be locked on the shaft) next to the centrifuge
7. Remove all the different layers of packing foam
8. If needed, clean the bowl if any residual packing material or dust is sitting at the bottom

4.2.3 Description

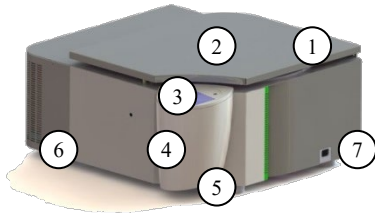

1. Lid
2. Window
3. Control panel
4. Electronic warhead
5. Main switch
6. Cooling unit (refrigerated model only)
7. Electrical outlet

4.3 Site preparation

Prepare a stable, clean and levelled support (e.g. laboratory bench). This support must be able to support the weight of the centrifuge and its use, and be firm enough so as not to generate or maintain vibration. Such vibrations would degrade the results of the centrifugation, and may result in an unbalanced error.

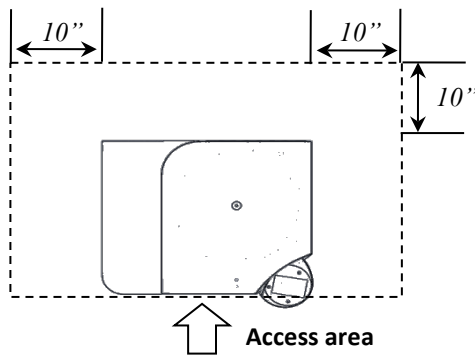

A clearance of 10 inch (250mm) around the centrifuge should be arranged according to IEC 61010-2-020: No potentially hazardous material, nobody or no object shall be deposited within the free space.

Open space around the centrifuge

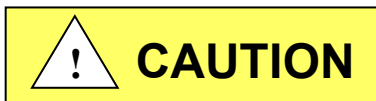

It is recommended that no less than two people are present to manually lift the centrifuge onto the laboratory bench.

4.4 Electrical environment

The centrifuge requires must be 230V/50Hz or 115V/60Hz, single phase, (current rating varies per centrifuge model, reference Electrical/Environmental Requirements).according to the manufacturer sheet on the back of the unit.

The centrifuge must be plugged into an outlet with protective earthing connection with the standard power cord.

The electrical outlet into which the centrifuge is connected should be readily accessible for maintenance purposes.



Do not position the centrifuge to prevent access to the power cord.

The power cord plug serves as the disconnect and should remain readily accessible. The electrical outlet should be on its own branch circuit, protected with a circuit breaker at the distribution panel near the centrifuge.

5.0 Operating the NU-C200



5.1 First Start / Powering

The first start must fulfill the conditions of the IEC 61010-2-020 safety standard



HOW TO GREASE A NUWIND CENTRIFUGE

When the following screen appears:



Grab the synthetic grease container and the brush provided with your centrifuge.

Using the tip of the brush, dispense a small amount of grease on each of the following locations:



2. On the drive shaft of the motor



1. On the lid latch



3. On each of the rotor trunnions (selected rotors)



You can change the frequency of this reminder in the **User Preferences** settings by clicking on this icon: 

Process 20-1335-DG-EN-V1-201508

5.1.1 Rotor assembly

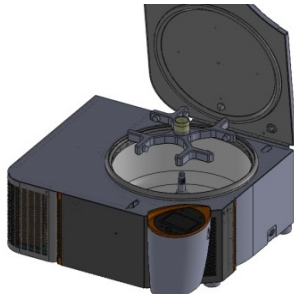

1. Clean and lubricate the motor shaft by depositing a thin film of the food grade grease supplied.

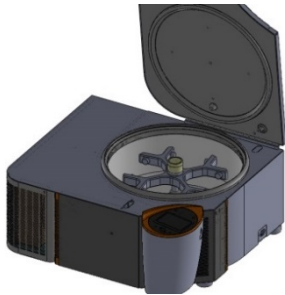

2. Place the rotor above the drive shaft.
3. Slide the rotor on the drive shaft.
4. A click indicates that the rotor is locked.
5. Clean and lubricate the pins by depositing a thin film of the food grease supplied.

5.1.2 Position the buckets

Swing-out rotors are used with round buckets or micro titration buckets.



1. Place the buckets in the corresponding numbered locations.

5.1.3 First powering

Activate the switch on the bottom right of the control center.

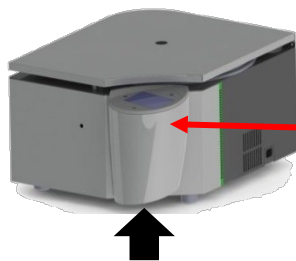

On/Off Switch position
Under Control Center

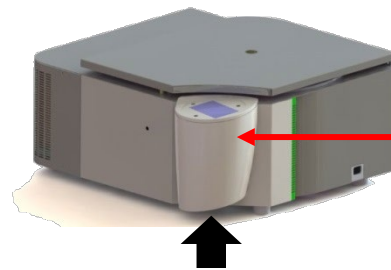

On/Off Switch position
Under Control Center

5.1.4 Using the interface

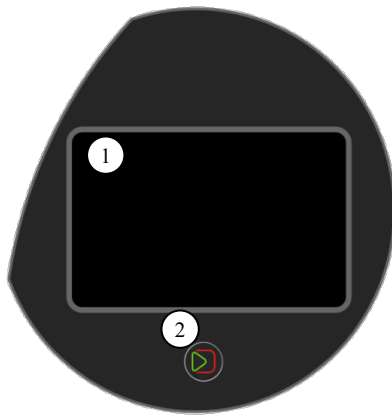

1. Touch screen for direct access to various functions.
2. Single button for easy operation.
This button allows the validation, the start of a cycle, but also the interruption of a cycle, and the output of a menu. The functions accessible through this single button are activated as required by the microcontroller.

5.1.5 Opening the lid

On the first start, the lid may not open right away due to a long storage in a cold environment. In this case, warm-up the jacks by repeated manual shifting of the lid downwards.

To open the lid, press the button .

5.1.6 Rotor loading and balancing

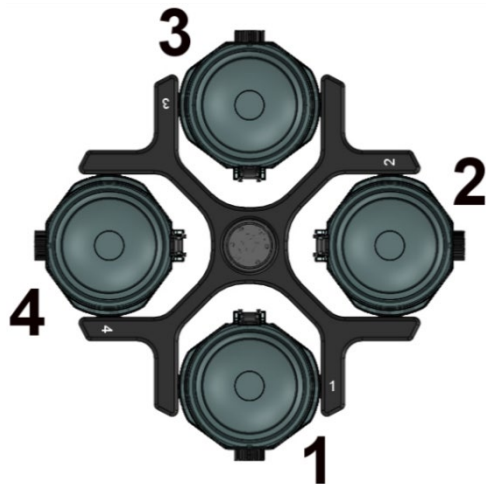

Position the 4 numbered buckets in their corresponding positions on the rotor. **Each bucket should pivot freely in its slot.**

Place the inserts corresponding to the tubes to be centrifuged in the four buckets

The buckets must be symmetrically distributed.

For better balance, each numbered bucket must be placed in the corresponding position marked on the rotor.

Each position on the rotor must be equipped with its bucket.

Do not use a rotor without its complete set of four buckets.







Maximum loads according to the type of rotor are specified in the annex.

The centrifuge tolerates an imbalance of 15grams.

If the imbalance is higher than the tolerated threshold, an imbalance detection system stops the centrifuge automatically.

The following message appears: "Imbalance" and the rotor stops in free wheel mode without braking system.

Excessive imbalance is likely to damage the turning components and/or the centrifuge.

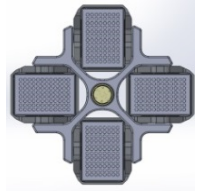
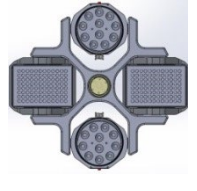
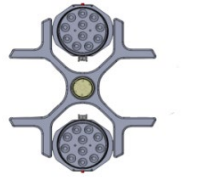
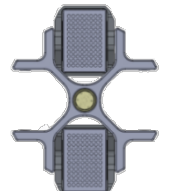
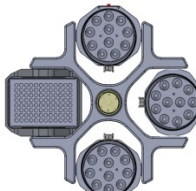
Loading the buckets					
Allowed:				Forbidden :	
					
Loading the rotor					
Allowed: Symmetrical loading				Forbidden: Incomplete loading Asymmetrical loading	
					

5.1.7 Quick start-up

Before using the centrifuge, make sure it has been properly installed.

QUICK START GUIDE

CENTRIFUGATION MENU

← N°10 → Program Back to Home Screen

5 7 15000 11:21 11
16000 RPM 20:00 min:sec 10°C

HOME SCREEN

Program

← N°10 → Access program catalog (01-99)

Change program name

Set Acceleration slope

Set Braking slope

Set Speed

Rotor Selection

Set Timer

Set Temperature (Refrigerated model only)

SAVE PROGRAM

Press 5 sec to lock or unlock program

USER PREFERENCES:

- Speed in RPM or RCF as default
- Frequency for greasing reminder (in cycles)
- Shows Usage log of centrifuge
- Temperature displayed in Celsius or Fahrenheit
- Count At or Count Go
ON: timer starts when set speed is reached
OFF: timer starts when you press start
- Shows Error log of centrifuge
- Change background color
- ON / OFF - end of cycle audible alarms

SERVICE MENU (restricted access)

HARDWARE-SOFTWARE INFORMATION

NuAire, Inc. | 2100 Fernbrook Lane | Plymouth, MN 55447 | U.S.A. | 763.553.1270 | www.nuaire.com
Process-20-1332-GD-EN-V1-201508

5.2 Operating

5.2.1 Settings

This section is accessible through the Admin section. It allows the creation and/or modification of a program and the customization of the centrifuge.

5.2.2 Create / edit a program name

Visual	Instruction	Control
	<p>Select the program to create/edit</p> <p>Note: 99 programs are available, from 01 to 99.</p>	 
	<p>The program can be modified when the protection icon is an open lock: </p>	
	<p>Edit the title screen by pressing on the title.</p>	
	<p>Enter the new title</p> <p>Save the new title by pressing "Save".</p> <p>Note: To delete the entire text:</p> <p>To exit the menu without saving changes:</p>	  
	<p>Confirm saving</p> <p>Save any changes</p> <p>Exit without saving changes:</p>	  
	<p>The program has been saved. (The lock is not activated).</p>	

5.2.3 Set program settings

Visual	Instruction	Control
	<p>Select the program to edit</p>	
	<p>Select the desired parameter by pressing the icon:</p> <p>Acceleration slope (from 1 to 9) 1: slowest acceleration 9: fastest acceleration</p> <p>Braking slope (from 0 to 9) 0: no braking at all 1: slowest deceleration 9: fastest deceleration</p> <p>Centrifuge speed (in RPM or RCF)</p> <p>Cycle time</p> <p>Setpoint temperature (only on the refrigerated model)</p>	    
	<p>Change the value (e.g. speed).</p> <p>Confirm</p>	
	<p>Confirm settings</p> <p>Save any changes</p> <p>Exit without saving changes:</p>	  

5.2.4 Set speed in RPM or RCF

Visual	Instruction	Control
	<p>Access the speed setting key</p>	
	<p>Press on the icon RPM to modify the unit from RPM to RCF.</p>	
	<p>Enter the RCF (g) value desired, Confirm</p> <p>Note: The rotor name and radius will be Displayed below the picture of the rotor.</p>	
	<p>The program will now display the RCF value (g).</p>	

5.2.5 Protect the settings of a program



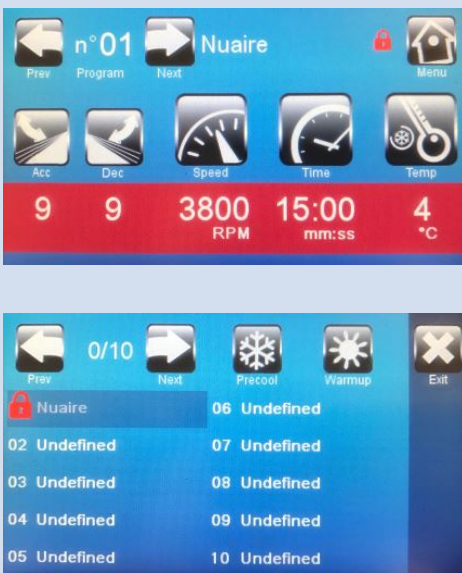



From an Admin profile, a program can be locked to prevent any modifications of the settings

Visual	Instruction	Control
	<p>Select the program to lock</p>	
	<p>Press on the open lock for 4 seconds.</p>	
	<p>The lock is now closed. The program is now protected.</p> <p>Note: To remove the protection, enter the program through an Admin user profile and press on the closed lock for 3 seconds. It will then re-open. You are now able to modify the program.</p> <p>In the list of programs, a lock appears in front of the program</p>	

5.2.6 Centrifuge: Use a program

Turn on the centrifuge. The switch is in the lower right portion.

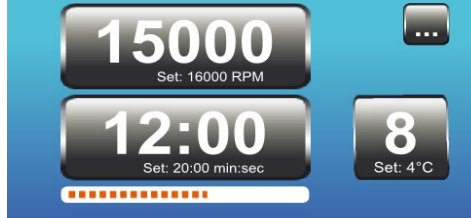
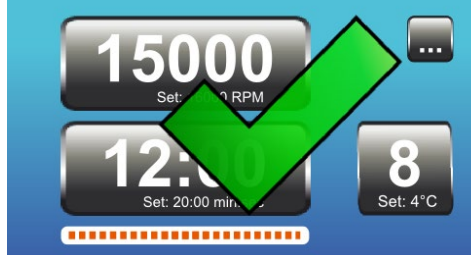
Any user can access a program (user, admin, service tech)

Visual	Instruction	Control
	<p>Select the program you want to use</p>	
	<p>Load the rotor and buckets as instructed in 6.1.6</p>	
	<p>Close the lid</p>	
	<p>Start the cycle</p>	
	<p>Centrifugation starts. The progression bar appears</p>	
	<p>Open the lid when finished Remove the tubes.</p>	

5.2.7 Interrupt centrifugation

Visual	Instruction	Control
	<p>During a centrifugation, press the Start/Stop button.</p>	
	<p>The rotor will start slowing down until complete stop</p>	
<p>Open the lid.</p>		

5.2.8 Open after an electric power failure / Emergency Stop



This operation must be performed by a person trained in centrifugation-related risks.
 In case of power failure, the lid cannot be opened by the engine unlocking control.
 You must wait 15 minutes for the rotor to come to a complete stop before opening manually.

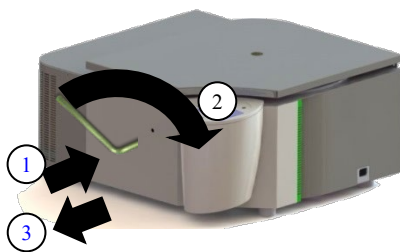







Turn off the power by pressing the switch to the “0” position.
 Punch the safety label on the front panel, using the wrench provided. Insert it fully into the cavity.
 Turn it clockwise to release the lid.
 Remove the wrench.
 Unload samples.

Following a manual release, the wrench must be removed from its housing to prevent accidents related to the rotation of the wrench during the activation of the locking mechanism. In addition, the security indicator label must be replaced during a safety check carried out by an authorized technician.







5.2.9 Precooling

On the Refrigerated model, a "Pre-cooling" cycle prior to centrifugation allows to cool the centrifuge down to 4 degrees Celsius so it is ready for temperature sensitive samples.





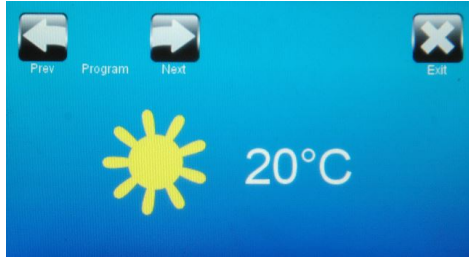

Visual	Instruction	Control
	<p>Access to the list of programs by pressing this icon :</p>	
	<p>Select the pre-cooling program: Rotor: Standard Precool</p> <p>This program is set to cool the centrifuge and accessories down to 4°C during a 22 minute cycle at 2500 RPM. Acceleration and Deceleration slope are both set on 9 and cannot be modified.</p> <p>Air: Smart Precool</p> <p>This program is set to cool the centrifuge until the probe temperature reaches 4°C and will stop when the temperature is reached.</p>	
	<p>*Select Rotor or Air in user preferences</p> <p>Start the cycle by pressing</p> <p>The temperature inside the bowl will show on the display</p>	

5.2.10 Prewarming



















On the Refrigerated model, a "Pre-warming" cycle prior to centrifugation allows to warm the centrifuge so it is ready for a protocol at ambient temperature or warmer (especially after a cycle at a colder temperature).

Visual	Instruction	Control
	<p>Access to the list of programs by pressing this icon :</p>	
	<p>Select the pre-warming program:</p> <p>This program is set to warm the centrifuge up to 20°C during a 20min cycle at 5,100 RPM. Acceleration and Deceleration slope are both set on 9 and cannot be modified.</p>	
	<p>Start the cycle by pressing</p> <p>The temperature inside the bowl will show on the display</p>	





5.2.11 Other menus

Visual	Instruction	Control
	<p>Access to other menus by pressing :</p>	
	<p>Select the menu</p>	
	<ul style="list-style-type: none"> User Preferences 	
	<ul style="list-style-type: none"> Service menu 	
	<ul style="list-style-type: none"> Information 	
	<ul style="list-style-type: none"> Go back to the centrifugation screen. 	





5.2.12 User Preference

Visual	Instruction	Control
	<p>Access the « User Preferences » menu via the following icons:</p>	
	<ul style="list-style-type: none"> Type of speed displayed: RPM or RCF (G force) 	
	<ul style="list-style-type: none"> Type of temperature displayed : Celsius or Fahrenheit 	
	<ul style="list-style-type: none"> Frequency of Lubrication 	
	<ul style="list-style-type: none"> Timer settings 	
	<ul style="list-style-type: none"> Logbook 	
	<ul style="list-style-type: none"> Count 	
	<ul style="list-style-type: none"> Error logbook 	
	<ul style="list-style-type: none"> Keyboard 	
	<ul style="list-style-type: none"> Background Color 	
	<ul style="list-style-type: none"> Screen Saver 	
	<ul style="list-style-type: none"> End of Cycle Alarm 	
	<ul style="list-style-type: none"> Error Message Alarm 	
	<ul style="list-style-type: none"> Post Cool 	
	<ul style="list-style-type: none"> Pre-Cool Function 	
	<ul style="list-style-type: none"> Auto Lid 	
	<ul style="list-style-type: none"> Temperature Display Mode 	



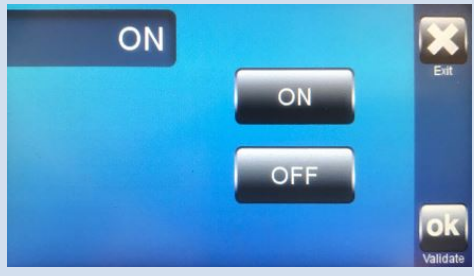



5.2.13 Type of Speed displayed (RPM OR RCF)

Visual	Instruction	Control
	<p>Select the unit you want displayed by default:</p>	
	<ul style="list-style-type: none"> RPM: Rotation Per Minute 	
	<ul style="list-style-type: none"> RCF: Relative Centrifugal Force, or G Force 	
<p>Please don't turn the unit Off during conversion</p>	<p>Confirm</p>	
	<p>Do not turn the centrifuge off at this point</p>	
<p>Please turn the unit Off and On again</p>	<p>You now have to restart the unit.</p>	

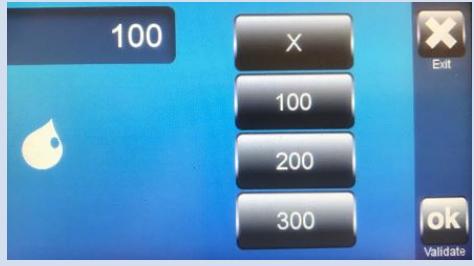





5.2.14 Type of Temperature displayed

Visual	Instruction	Control
Default : °C		
	Select you unit you want displayed by default:	
	<ul style="list-style-type: none"> • °C: Degree Celsius 	
	<ul style="list-style-type: none"> • °F: Degree Fahrenheit 	
	Confirm	

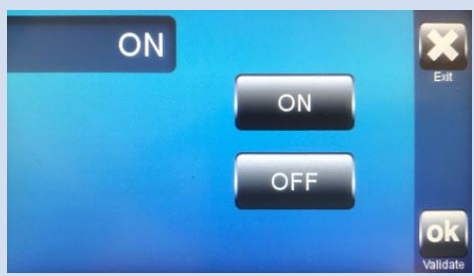



5.2.15 Frequency of lubrication

Visual	Instruction	Control
Default : 100		
	Select how many cycles you want between each lubrication reminder.	
	<ul style="list-style-type: none"> • No reminder (Not recommended) 	
	<ul style="list-style-type: none"> • 100 cycles (Default value) 	
	<ul style="list-style-type: none"> • 200 cycles 	
	<ul style="list-style-type: none"> • 300 cycles 	
Confirm		





5.2.16 Timer setting

Visual	Instruction	Control
Default : OFF		
	Select the type of timer:	
	<ul style="list-style-type: none"> • ON: The timer only starts when the centrifuge has reached the set speed in the program 	
	<ul style="list-style-type: none"> • OFF: The timer starts right when you start the cycle (Press ,.) 	
	Confirm	





5.2.20 Keyboard

Visual	Instruction	Control
Default : QWERTY	Changes the style of the keyboard	
	QWERTY : US Style	
	AZERTY : EU Style	
	Return	







5.2.21 Change background color

Visual	Instruction	Color
Default : BLUE	You can modify the background color of the display	
	Choose the color you want.	 
	Confirm	







5.2.22 Screen Saver

Visual	Instruction	Control
Default : ON	Enables the screen saver	
	<ul style="list-style-type: none"> ON : screen will turn off after 5 minutes on inactivity when not running. Touch the screen to power on 	
	<ul style="list-style-type: none"> OFF : Screen is always on when unit is powered 	
	Return	





5.2.23 End of Cycle Alarm

Default : ON	This function activates a beep when the cycle is complete.	
	<ul style="list-style-type: none"> ON : Upon stop the signal is triggered Pressing the key  stops the signal. 	
	<ul style="list-style-type: none"> OFF : No signal at the end of the run. This is the default. 	
		



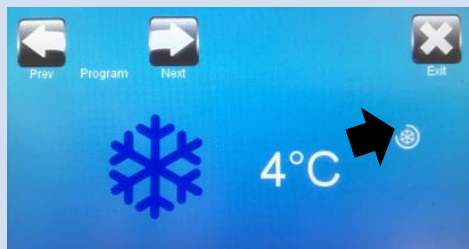

5.2.24 Error Message Alarm

Default : ON	This function activates a beep when an error message appears	
	<ul style="list-style-type: none"> ON : Upon error the signal is triggered Pressing the key  stops the signal. 	
	<ul style="list-style-type: none"> OFF: No signal upon error. This is the default. 	
		



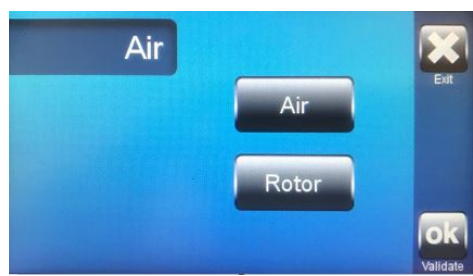

5.2.25 Post Cool

Default : OFF	This function maintains the temperature in the bowl between runs.	
	<ul style="list-style-type: none"> ON: After closing the lid the refrigeration the unit will maintain the temperature for 4 hours. Note: Upon opening the lid the 4 hour timer will restart. 	
	<ul style="list-style-type: none"> OFF: Bowl temperature is not maintained between runs. 	
		
	When Post Cool is activated this symbol  appears: <ul style="list-style-type: none"> On the main screen next to the thermometer. 	
	<ul style="list-style-type: none"> On the Precool screen right of the temperature. 	



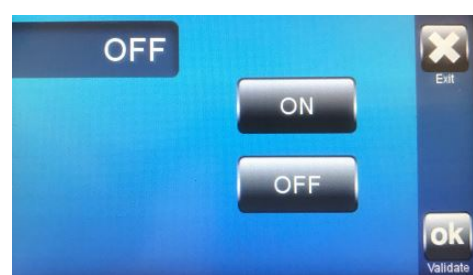



5.2.26 Pre Cool Function

Visual	Instruction	Control
Default : Air	Allows Pre Cool to 4°C in air or rotor mode.	
	<ul style="list-style-type: none"> AIR: Cooling to the temperature in the bowl. This is the default. 	
	<ul style="list-style-type: none"> ROTOR: Cooling for 22 minutes. At this point the rotor and accessories are cooled. 	
		

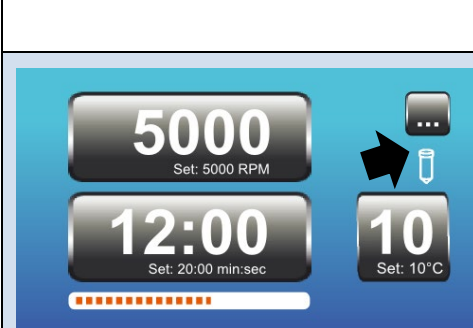

5.2.27 Auto Lid

Visual	Instruction	Control
Default : OFF	Automatically opens the lid after a run	
	<ul style="list-style-type: none"> ON : Lid will open automatically after run 	
	<ul style="list-style-type: none"> OFF : Lid remains closed after run 	
	Return	



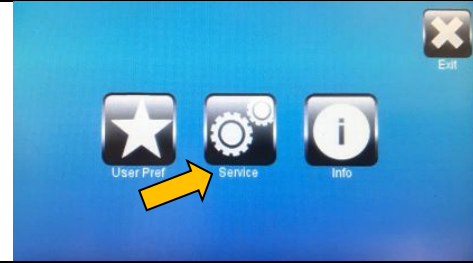

5.2.28 Temperature Display Mode

Visual	Instruction	Control
Default : Air	Allow for display of air or rotor temperature.	
	<ul style="list-style-type: none"> AIR: The temperature displayed is the temperature of the air in the bowl. This is the default 	
	<ul style="list-style-type: none"> ROTOR: The temperature displayed is that of a sample in a tube. The sample must have been previously stored at the same temperature. 	
	Confirm	
	<p>During Centrifugation: If the Rotor mode is selected the tube appears. If the Air mode is selected no logo appears.</p> <p>Pressing the temperature button can temporarily change the display mode.</p>	

5.2.29 Service Menu

Visual	Instruction	Control
	<p>This menu is only accessible to certified service companies.</p> <p>Exit</p>	

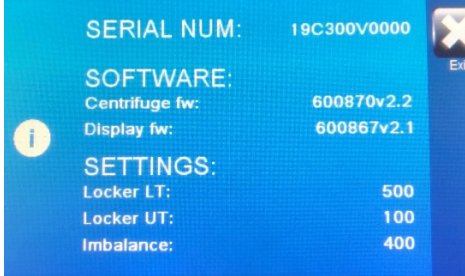
5.2.30 Information

Visual	Instruction	Control
	<p>Access the menu through this icon :</p>	
	<p>This menu provides general information on the Software and Hardware of the centrifuge :</p> <p>SERIAL NUMBER: Unique identification number of the centrifuge</p> <p>Centrifuge fw: Software version of the microcontroller</p> <p>Display fw: Software version of the display</p> <p>μController Board Id: ID of the microcontroller electronic board</p> <p>Locker LT: Locking tempo of the lid</p> <p>Locker UT: Unlocking tempo of the lid</p> <p>Imbalance: Imbalance calibration setting</p> <p>Return</p>	

6.0 Care and Maintenance



All maintenance actions on this equipment must be performed by a qualified technician who is familiar with the proper maintenance procedures required for this equipment

The device and its accessories may be contaminated.
Apply decontamination measures required before any maintenance.



Turn off the centrifuge power switch. Ensure you lock the switch when working on the unit, to avoid any accident from a third party.

Special care must be provided to maintain the original terms of safety and performance, to extend the life of accessories. A visual inspection can identify any signs of wear. An annual inspection may be requested according to relevant regulations

6.1 Care and Cleaning

6.1.1 Authorized maintenance products

Users should not use cleaning or decontamination methods different from those recommended by the manufacturer, as they may cause damage to the unit.

The following products and materials are allowed for maintenance:

- Distilled water,
- 70% IPA, peroxides or quaternary ammonium surface disinfectants.
- Lint-free cloth
- Soft non-metallic brush
- Lanolin or silicone spray

Forbidden products and materials:

- **Chlorine**-containing products (Bleach, chlorides, ...)
- **Saltwater**
- **Wire brush**

6.1.2 Centrifuge

Perform regular cleaning of the following parts to prevent any risk of corrosion in case of persistent impurity, and to ensure the hygiene of the working equipment.

External parts lid & keyboard:



- Use fluids and tissues impregnated with hydro-alcoholic solution or quaternary ammonium
- Check that the air vents are not obstructed.

Centrifuge chamber:

- Remove the rotor before cleaning the tank.
- Dry thoroughly after cleaning.
- Do not use fluffy fabric.
- Replace the rotor after cleaning the tank.

6.1.3 Rotor & Accessories

Use clear or distilled water to clean the rotor and buckets. A soft non-metallic brush or lint-free cloth can be used. Dry the rotor and accessories ensuring the least accessible areas are wiped.

Image	Operation
 <p data-bbox="415 506 532 531">Fig. 1 Rotor</p>	<p data-bbox="712 268 1312 327">To ensure a proper swinging movement of the buckets, clean all 8 trunnions of the rotor.</p>
 <p data-bbox="394 831 553 852">Fig. 2 Trunnions</p>	<p data-bbox="712 537 1122 562">Remove the leftover grease and dust.</p> <p data-bbox="712 600 1271 625">Apply a thin layer of food quality grease (provided).</p>
	<p data-bbox="712 861 1360 919">Also clean the buckets, more specifically the area in contact with the trunnions.</p>

Make sure to set the “greasing reminder” in the User Preferences menu.

To prolong the life of accessories, you can then place a thin film of silicone spray or lanolin.

Rotors, buckets, inserts can be autoclaved at 122.5 ° C / 252 ° F / 215 kPa for 15 minutes

 **Note:** When autoclaving, buckets, inserts, and rotors must be separated from each other. Autoclaving causes accelerated aging of plastics, and may change the color of the plastic. Perform regular cleaning to prevent any risk of corrosion in case of persistent impurity, and to ensure the hygiene conditions of working equipment.

6.1.4 Disinfection / Decontamination

Bio hazardous, radioactive and/or toxic materials:

Before any intervention, to ensure the safety of the operator, please refer to the laboratory’s decontamination protocol. The centrifuge and its accessories may be contaminated and require remediation in this case.



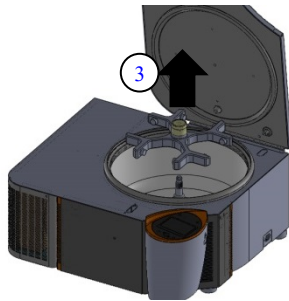
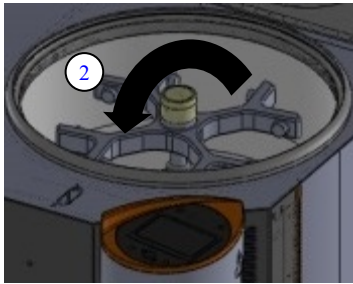

6.1.5 Dismantling the rotor

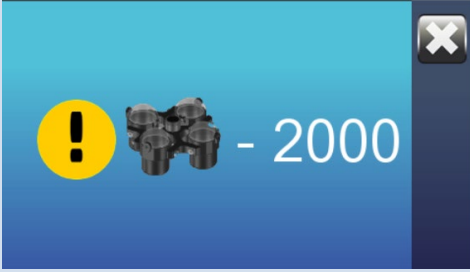

1. Open the lid.
2. Grab the red wheel on top of the rotor and turn it counterclockwise while holding the rotor firmly. Once you hear a “click” sound, the rotor is unlocked
3. Grab and lift the rotor with both hands once it’s unlocked.
4. Set the rotor on a flat surface or on one of NuAire’s rotor stand.

6.1.6 Limiting the duration of operation

The use of accessories and the rotors is limited in time to ensure the integrity of their mechanical strength. These limits are marked on the accessories.

Visual	Instruction	Control
	<p>When there is only 2,000 cycles left before the end of the theoretical life time of the rotor, this screen will be displayed. It shows the amount of cycles left before the rotor should stop being used (rotor and buckets). This value will decrease by 1 each time the rotor is being used.</p> <p>You can still use the centrifuge, but only as long as the value is higher than 0. Anticipate the purchase of a new set of rotor + buckets in the near future.</p>	
	<p>Once the rotor has reached the end of its theoretical life time, the screen will inform you that the rotor cannot be used.</p> <p>The rotor and buckets are obsolete and have to be replaced promptly. A certified technician has to configure the centrifuge for the new rotor.</p>	

6.1.7 Checking and testing accessories



Check that no trace of corrosion appears. Check also the absence of any mechanical damage (traces of impact, corrosion, cracking), or wear on the rotor and bucket.

In order to ensure optimal performances, once the accessories have reached half of their theoretical life time, we recommend inspecting them. This life time is different from one accessory to the other, and the value is engraved on the accessory (i.e.: Max cycles: 55,000 means that the accessory has a theoretical life time of 55,000 cycles)

For safety reasons, the use of accessories that have reached the end of their life cycle is prohibited. These components must be replaced.

6.1.8 Storage of accessories

Do not store the accessories on a wire rack. Oxidation build-up may appear and show premature wear of accessories

6.1.9 Annual maintenance

A periodic check of the centrifuge and accessories is required. Checks must also be carried out in accordance with the regulations in force: Functional (lubrication of the drive shaft, the lock, readability of labels), security (continuity of the protective ground connection, checking & maintenance of rotors and accessories) and centrifuge performance checks are recommended at least once a year.

Replacement of consumables (grease, provided)

Check that the grounding of the device is always properly secured by its power cable and the wall outlet it is connected to. The operator is not authorized to access the internal part of the equipment. A NuAire authorized technician will ensure maintenance.

6.2 Imbalance sensitivity detection

The centrifuge has a reaction to the load balancing faults which may be different depending on the media on which the centrifuge is placed. A calibration of the imbalance sensitivity is therefore necessary during installation.

Required equipment: Use the reference balancing kit AFI-71122002.

Access the unbalance sensitivity calibration menu.

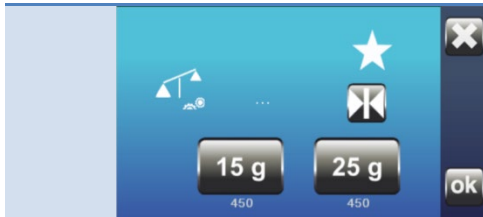

Low threshold

Equip a rotor swing-out and its 4 nacelles in the centrifuge.
Remove the inserts of the nacelles.

1. Place the round 15 gram weight in one of the nacelles and close the lid,
2. Press the button "15gr"
3. The rotor accelerates until it stabilizes.
4. The centrifuge shakes, then the rotor slows down.
5. The low threshold is then determined. It appears under the button "15 gr". (e.g. 480)
6. Open the lid and remove the 15 gram weight.
7. Place the 25 gram weight in the same nacelle.
8. Proceed in the same way as for the 15 gram weight.
9. The low threshold is then determined. (e.g. "520")
10. Open the lid and remove the 25 gram weight.



High threshold

11. Press on the Next button to average the setting. (e.g. $[480+520]/2 = 500$)
The average value is displayed.
By default, the factory setting value is 500.

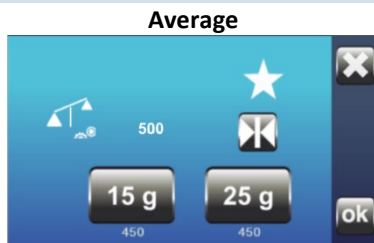

Check

High threshold:



Do not adjust this threshold with a weight greater than 25 gr.

This would cause a breach of warranty.

The appliance has been dimensioned for a maximum threshold of 25gr.

Low threshold:

The following steps are compulsory.

12. Place the 15 gr + 10 gr weights in a nacelle.
13. Start the cycle. 2000 rpm / 1 minute / 9 Acceleration / Braking 9
14. The centrifuge must stop during the acceleration, and display the message ERROR1:
The 25 gr imbalance is not tolerated.

Repeat the High threshold check 3 times: ERROR1 must appear each time.

15. Leave only a weight of 15 gr in a nacelle.
16. Start the cycle. 2000 rpm / 1 minute / 9 Acceleration / Braking 9
17. The centrifuge should achieve the desired speed and then slow down and stop without the following error message appearing:
The 15 gr imbalance must be tolerated.
Repeat the Low threshold check 3 times: Each cycle should take place normally.

7.0 Error Messages, Troubleshooting, Option-Diagnostics

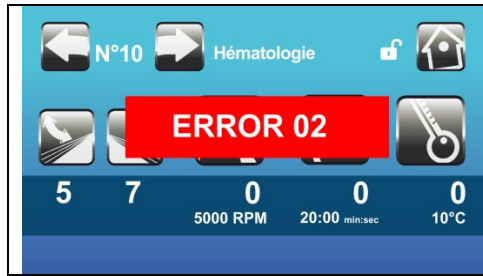

In case of a problem, the display shows an error message and an error number.

Error / Message		Cause	Solution
01	LOCK FAIL	The lid is open when the centrifuge starts.	Close the lid. Wait for complete closing of the lid before starting a new cycle.
		The lid sensor is malfunctioning.	Contact a Certified Technician.
02	IMBALANCE	The rotor buckets are not loaded symmetrically.	Wait until complete stop. Open the lid. Load the buckets as shown in manual. Start a new cycle.
		The centrifuge is installed on an uneven bench.	Install the centrifuge on a flat bench/table, as described in manual.
		The imbalance detector is not well calibrated.	Contact a Certified Technician.
03	BOWL OVERTEMPERATURE	The temperature in the bowl is higher than 43C; the room temperature is too high.	Wait until complete stop. Turn the AC or Ventilation system on to obtain an ideal ambient temperature as described in manual.
		The temperature set in the program is not adapted.	The settings for speed / temperature are not compatible with a normal utilization.
		The temperature of the samples is too high.	Make sure the samples can be cooled to down to a temperature between 4C and 37C during 1 hour
		The refrigeration doesn't work.	Contact a Certified Technician.
		The temperature probe is malfunctioning.	Contact a Certified Technician.
		The difference between the air temperature and the over temperature alarm set point is greater than the set value.	Check the value of the temperature alarm threshold. Change program settings: speed and/or temperature.
04	MOTOR OVERTEMPERATURE	The motor temperature is too high.	A « no-brakes » stop is occurring. Wait 30 minutes before opening the lid. Turn the AC or Ventilation system on to obtain an ideal ambient temperature as described in manual.
		The centrifuge is being used too intensively (ventilated model).	Let the centrifuge cool down between cycles.
		The motor has been damaged	Contact a Certified Technician.
		The temperature sensor on the motor has a bad connection.	Contact a Certified Technician.
05	ERROR MICROCONTACTOR ON LOCKING MECHANISM	One of the micro contacts is damaged or non-working. There is a bad connection to the micro contacts.	Contact a Certified Technician.
06	MICROCONTACT NOT SEEN - OPEN	The micro contact doesn't work. The auxiliary micro contact is not working. The connection of the auxiliary micro contact is not good.	The micro contact was seen as closed when it should have been seen as open when the centrifuge started. Contact a Certified Technician.

07	MICROCONTACT NOT SEEN – CLOSED	The power contactor doesn't work. The open position switch was released after the lid closed. The micro contact doesn't receive a command. The coil of the micro contactor is not working properly.	The micro contact was seen as open when it should have been seen as closed. Contact a Certified Technician.
-----------	--------------------------------	--	--

Error / Message		Cause	Solution
08	ERROR LID SAFETY	The board with tachometer / accelerometer is working improperly. The connection to these parts is not good. The sensor for the closed lid position was released after the centrifugation started.	The lid slightly opened during the security auto test when the cycle started.
09	NO SPEED SIGNAL AT START	The speed sensor is working improperly. The board with tachometer / accelerometer is working improperly. The connection to these parts is not good.	The speed cannot be read within the first 5s of the cycle.
10	SPEED SIGNAL LOST	The speed sensor is working improperly. The board with tachometer / accelerometer is working improperly. The connection to these parts is not good.	The speed signal was lost during rotation. Unit will be locked for 30 minutes. Acknowledge error and after 30 minutes lid will be able to be opened and run normally again.
11	WRONG SPEED SIGNAL	The speed sensor is not working properly. The board with tachometer / accelerometer is working improperly. The connection to these parts is not good. Magnets from the tachometer might have been lost.	The speed signal is not correct.
12	OVERSPEED	Major error, the centrifuge will stop.	The speed measured is higher than the maximum speed allowed for this rotor. Contact a Certified Technician.
13	Bus I ² C Accelerometer	The board with tachometer / accelerometer is working improperly. The connection to these parts is not good. The microcontroller board is working improperly.	Problem of communication with the accelerometer.
14	Bus I ² C Temperature probe	The microcontroller board is working improperly.	Problem of communication with the temperature measurement.
15	LID OPEN DURING ROTATION	Manual lid opening during centrifugation. Wrong calibration of locking mechanism.	The lid was manually opened or the hook was released during the centrifugation. Contact a Certified Technician.
	NO DISPLAY	No power.	Verify the power plug is connected properly. Check the power in the laboratory. Turn the switch on.
16	TEMPERATURE CONTROL ISSUE	Temperature probe out of service.	Verify that the temperature probe is properly installed under the lid and replace it if necessary. Remove the probe and measure the resistance. The value must be 500+ - 100 Ohm (Probe PT500)
17	ERROR OVERSPEED SAFETY	The startup test of the overspeed safety has failed.	Microcontrol board is defaulting: Replace the control center.

Error / Message		Cause	Solution
18	SPEED SIGNAL IS LOST	<p><u>2 possible situations:</u> Signal permanently lost: Impossible to clear the Error and open the lid: 30 minute safety timer is running, Wait for 30mn before being allowed to open the lid</p> <p>Speed signal recovered during braking: Error can be erased after full stop: lid can be opened as soon as error is acknowledged</p>	<p>After erasing the error, cycle the power supply and try to launch a new cycle. If Error 18 is detected again, call technical service</p>
19	SPEED SENSOR ISSUE	<p><u>2 possible situations:</u> Signal permanently lost: Impossible to clear the Error and open the lid: 30 minute safety timer is running, Wait for 30mn before being allowed to open the lid</p> <p>Speed signal recovered during braking: Error can be erased after full stop: lid can be opened as soon as error is acknowledged</p>	<p>After erasing the error, cycle the power supply and try to launch a new cycle. If Error 19 is detected again, call service</p>

In case of malfunction, contact after-sales service if the previous table does not eliminate the error. You will be asked for the type of centrifuge and the serial number for more effective troubleshooting.

Never try to disassemble or fix the unit on your own: the risks of getting injured or electrocuted are high. The manufacturer warranty would then be void. Only a certified technician is authorized to perform such operations.

8.0 Electrical/Environmental Requirements

8.1 Electrical (Supply Voltage Fluctuations Not to Exceed +/- 10%)

NU-C200V	115V	60Hz	8.5 Amp	1 Phase	UL/UL-C Listed
NU-C200R	115V	60Hz	17 Amp	1 Phase	UL/UL-C Listed
NU-C200V-E	230V	50Hz	4 Amp	1 Phase	CE Certified
NU-C200R-E	230V	50Hz	8.5 Amp	1 Phase	CE Certified

8.2 Operational Performance (for indoor use only)

Environment Temperature Range: 60°F - 85°F (15°C - 30°C)

Environment Humidity: Maximum relative humidity 80% for temperatures up to 31°C decreasing linearly to 50% relative humidity at 40°C

Environment Altitude: 6562 Feet (2000 meters) above sea level

8.3 Light Exposure

Standard Fluorescent Lighting @ 150 ft. candles (1614 LUX) maximum intensity.

8.4 Installation Category: 2.0

Installation category (overvoltage category) defines the level of transient overvoltage, which the instrument is designed to withstand safely. It depends on the nature of the electricity supply and its overvoltage protection means. For example, in CAT II, which is the category used for instruments in installations supplied from a supply comparable to public mains such as hospital and research laboratories and most industrial laboratories, the expected transient overvoltage is 2500 V for a 230 V supply and 1500 V for a 120 V supply.

8.5 Pollution Degree: 2.0

Pollution degree describes the amount of conductive pollution present in the operating environment. Pollution degree 2 assumes that normally only non-conductive pollution such as dust occurs with the exception of occasional conductivity caused by condensation.

8.6 Chemical Exposure

Chemical exposure should be limited to antibacterial materials used for cleaning and disinfecting.

CHLORINATED AND HALOGEN MATERIALS ARE NOT RECOMMENDED FOR USE ON STAINLESS STEEL SURFACES.

8.7 EMC Performance (classified for light industrial)

Emissions: EN61326

Immunity: EN61326



Class A equipment is intended for use in an industrial environment. In the documentation for the user, a statement shall be included drawing attention to the fact that there may be potential difficulties in ensuring electromagnetic compatibility in other environments, due to conducted as well as radiated disturbances.



DECLARATION OF CONFORMITY

Application Council Directive(s):

EMC Directive 2014/30/EU
European Standard EN 61326-1:2006
Low Voltage Directive 2014/35/EU
European Standard EN 61010-1 (2nd Edition)
European Standard EN 61010-2-020 (2nd Edition)
RoHS Directive 2011/65/EU
WEEE Directive 2002/19/EC

Manufacturer's Name: NuAire, Inc.
Manufacturer's Address: 2100 Fernbrook Lane
Plymouth, MN, 55447, USA

Importer's Name: See Shipping/Customs Documents

Importer's Address: See Shipping/Customer's Documents for your equipment

Name of Equipment: Laboratory Equipment - Centrifuges

Model Numbers: NU-C200V-E NU-C2500V-E NU-C300V-E NU-C300RF-E
NU-C200R-E NU-C2500R-E NU-C300R-E
*NU-SCxxxx+

+ With and Without Suffixes

Serial No.: Various – See Individual Declaration
Year of Manufacture: 2015 and Subsequent

* Denotes special product, product evaluation to be conducted on an individual basis.

I hereby declare that the equipment as specified conforms to the above requirements.

Date: January, 2017 Location: Plymouth, MN, USA

European Contact:
IBS Tecnomara GmbH
Ruhberg 4
D-35463, Fernwald, Germany

William F. Peters
V.P. Engineering

Best Products. | Best Performance. | Best Protection.

NuAire, Inc. | 2100 Fernbrook Lane | Plymouth, MN 55447 | U.S.A | ph: 763.553.1270 | fx: 763.553.0459 | tf: 800.328.3352 | www.nuaire.com

9.0 Disposal and Recycle

Before disposing the equipment, it must be decontaminated and cleaned to protect people, the environment and equipment. Legal regulations must be observed when disposing of the unit.



Electrical appliances are governed by national regulations based on the 2002/96/EC European Directive on electrical and electronic equipment waste WEEE.

According to this directive, no equipment supplied after August 13, 2005 in the Business-to-Business sector - which includes this centrifuge - must be disposed of with household waste.

For easy identification, the appliances are marked with the symbol displaying a crossed out dustbin.

Centrifuges that are no longer in use and are ready for disposal contain reusable materials.

ALL components may be disposed and/or recycled after they are known to be properly disinfected.



BIOHAZARD

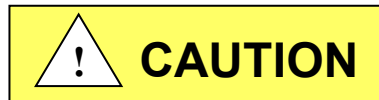

Prior to any disassembly for disposal, the centrifuge must be decontaminated.



RECYCLE



LEAD FREE

Component	Material
Main Cabinet	Painted Steel
Bowl	Stainless Steel
Inner Lid	Plastic
Motor	Various Steel/Copper
Printed Wiring Assembly	Lead Free Electronic
Wire	PVC Coated Copper
Connectors	Nylon
Hardware	Stainless Steel and Steel

 **Note:** Material type can be verified with use of a magnet with stainless and aluminum being non-magnetic.

Annexes

1.0 Theoretical Basics of Centrifugation

1.1 Basics

Relative Centrifugal Force

In customary practices and usages of centrifugation, the quantization unit of angular velocity (denoted N), is the revolution per minute (abbreviated rpm, RPM, r / min, or $r \cdot \text{min}^{-1}$). This is a measure of frequency of rotation. It corresponds to the number of full rotations completed in one minute around a fixed axis.

The derived frequency unit for SI units is Hertz, with the symbol Hz. Its expression in terms of SI is s^{-1} .

$$1 \text{ rpm} = \frac{2\pi}{60} \text{ rad} \cdot \text{s}^{-1}$$

Laboratory centrifuges are used to separate solids of different densities in suspension, applying the relative centrifugal force (RCF for short) on samples. The effective force increases with the square of the rotational speed and distance from the axis of rotation. This force, known as "g-force" is quantified as the number of "g" applied to the sample. No SI units are provided.

The following formula is used to convert the angular speed to "g-force"

$$RCF = \frac{\pi^2 N^2 r}{9 \cdot 10^5 g}$$

RCF Relative Centrifugal Force, "g"

N: angular velocity, revolutions per minute

r: radius of the circular path of the sample, mm

g: acceleration of standard gravity, 9806 65 meters per second per second (ms^{-2})

The relative centrifugal force depends on the speed and the rotation radius.

An approximation, denoted F, is used in practice to calculate the value of the relative centrifugal force:

$$F = 1.118 \times r \times \left(\frac{N}{1000} \right)^2$$

Speed, based on the relative centrifugal force is calculated by the following formula:

$$N = 1000 \times \sqrt{\frac{F}{1.118 \times r}}$$

Integral spin

It is the accumulated relative centrifugal force acting on the centrifuged object at the corresponding time.

It is outlined by the colored surface of the chart below.

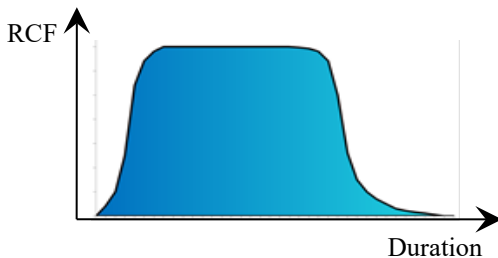

1.2 Nomogram

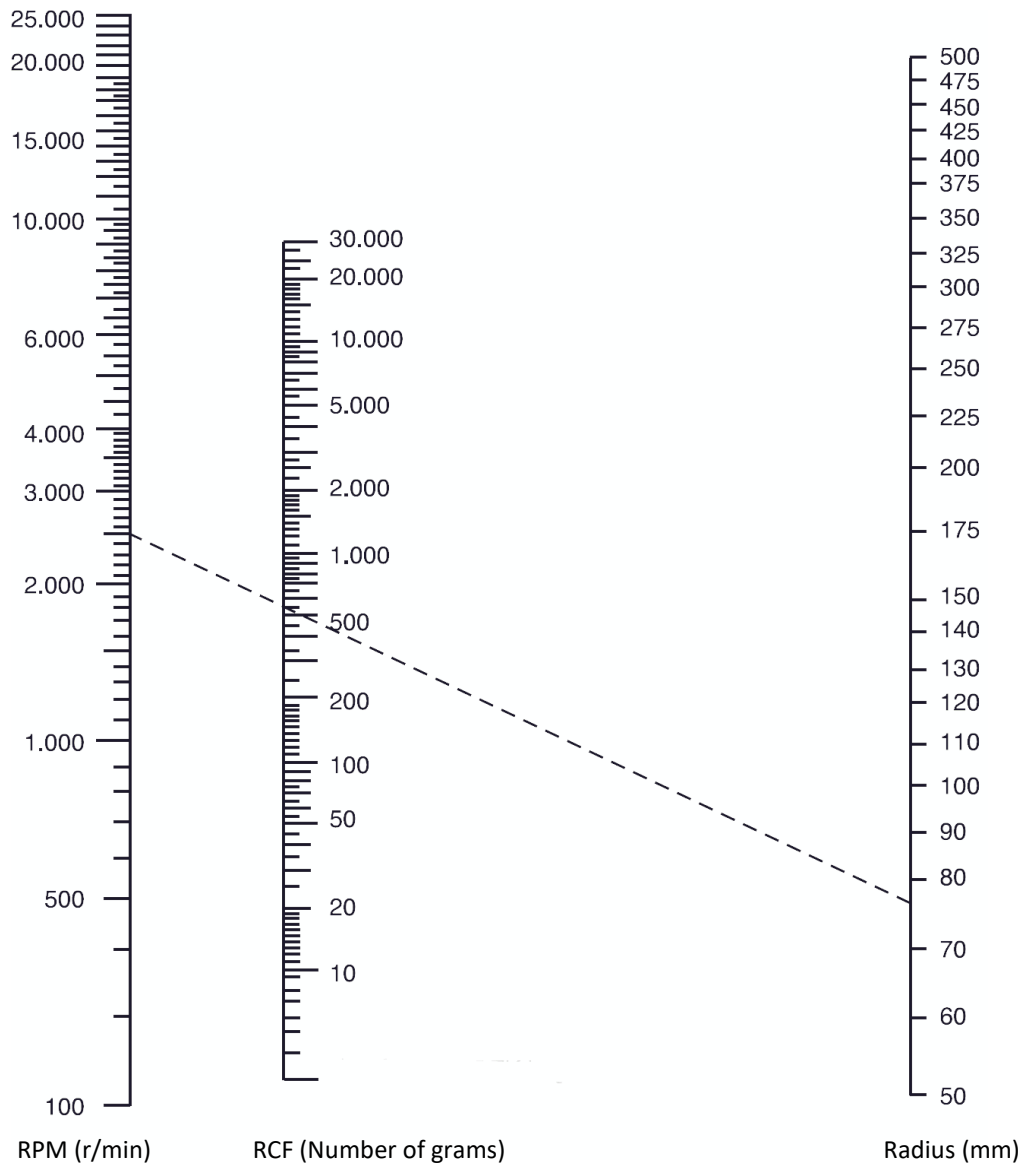

The nomogram graphically connects by a line segment a speed to the relative centrifugal force (RCF) as a function of the radius of rotation selected.

In the example above, the speed of 2500 rpm corresponds to a relative centrifugal force of 550 g for a radius of rotation of 79 mm

2.0 Accessory Specifications

2.1 Swing-Out Rotor NU-RX625

Rotor		
Part number:	NU-RX625	
Equivalent reference	NU-RX500	
Description:	2.5 liter swing-out rotor	
Maximum capacity:	4x625 ml	
Fastening:	ClickSpin system	
Maximum rotor speed	5100 rpm	
Maximum centrifugal force of the rotor	5350 xg (with NU-B625 buckets)	
Lifetime	55,000 cycles 8 years	
Centrifuge performance	Maximum speed	Maximum centrifugal force
NU-C200 Ventilated	4500 rpm	4166 xg
NU-C200 Refrigerated	5100 rpm	5350 xg
Rotors RX500 and RX625 are compatible with buckets B500 and B625 as well as lids L500 and L625		



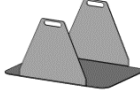

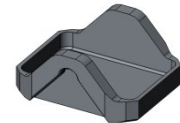



Microplate buckets		
Part number:	NU-BXDW	
Description :	Microplate bucket for rotor NU-RX625 (Sets of 2 OR 4)	
Maximum speed	5100 rpm	
Maximum RCF	5350 xg	
Capacity standard Microplates	4 plates per bucket (total of 16)	
Capacity Deep well blocks	1 block per bucket (total of 4)	
Maximum capacity	720 grams	
Lifetime	55,000 cycles 8 years	
Maximum Radius(***) :	155 mm	
Included :	Neoprene pad (1 per bucket)	
	Stainless Steel extractor (1 per bucket)	



(***) The radius is the distance between the rotor shaft and the bottom of the microplate bucket (without pad and extractor) when the bucket is spinning in a horizontal position (during centrifugation)

Possible Configurations:

Loading the buckets			
Allowed:			Forbidden :
			
			
Loading the rotor			
Allowed:			Forbidden:
Symmetrical loading			Incomplete loading
			Asymmetrical loading
			

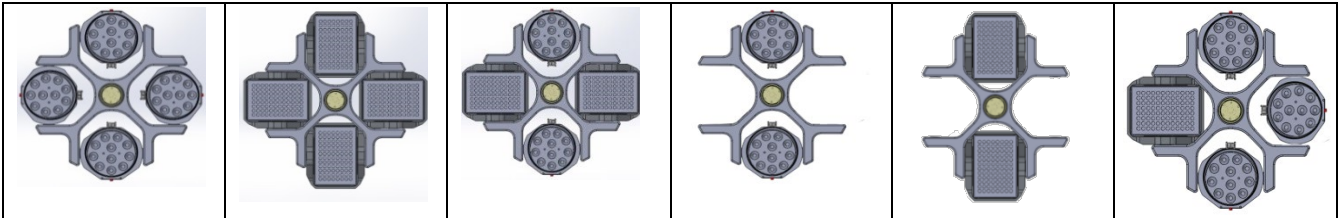

Accessories for NU-RX625

Buckets				
Part number :	NU-B625			
Description:	Round Bucket 625 ml (Set of 4)			
Volume	500 ml Max : 625 ml (Bottle + Lid)			
Maximum speed	5100 rpm			
Maximum RCF	5350 xg			
Maximum capacity :	750 grams			
Lifetime	55,000 cycles 8 years			
Maximum Radius :	184 mm			
Lid				
Part number :	NU-L625			
Description :	Airtight lid 625 ml (Set of 4)			
Inserts (Sets of 2 OR 4)				
Part number	Radius(*)	Capacity per insert	Total capacity(Rotor)	
NU-2T2	182 mm	46 x Tubes 1.5-2 ml MicroTube	184	
NU-2T5	182 mm	23x Tubes 5/7 ml Round bottom	92	
NU-2T10 (**)	182 mm	19x Tubes 10 ml (*) Round bottom	76	
		7x Tubes 15 ml type CPT Round bottom (*)	28	
NU-2T15C	184 mm	11x Tubes 15 ml Conical bottom	44	
NU-2T50C	184 mm	5x Tubes 50 ml Conical bottom (***)	20	
NU-2T50CL	184 mm	4x Tubes 50 ml Conical bottom	16	
NU-2T50S (***)	182.3 mm	5x Tubes 50 ml Skirted bottom Non-waterproof	20	
NU-2T50SL	183 mm	5x Tubes 50 ml Skirted bottom	20	
NU-2T200	184 mm	1x Bottle 175 ml Conical bottom	4	
		1x Bottle 225 ml Conical bottom		

NU-2T400	182 mm	1x Bottle 350 ml Flat bottom	4	
NU-2T625	184 mm	1x Bottle 625 ml Flat bottom	4	No insert required

(*) The radius is the distance between the rotor shaft and the bottom of the inserts when the bucket is spinning in a horizontal position (during centrifugation)

(**) Same insert for many types of tubes.

(***) Can only be used without a lid

2.2 Swing-Out Rotor NU-RX400











Rotor		
Part number:	NU-RX400	
Equivalent reference	NU-RX250	
Description:	1.6 liter swing-out rotor	
Maximum capacity:	4x400 ml	
Fastening:	ClickSpin system	
Maximum rotor speed	5100 rpm (with NU-B400 buckets)	
Maximum centrifugal force of the rotor	5470 xg (with NU-B400 buckets)	
Lifetime	70,000 cycles 12 years	
Centrifuge performance	Maximum speed	Maximum centrifugal force
NU-C200 Ventilated	4500 rpm	4256 xg
NU-C200 Refrigerated	5100 rpm	5470 xg
Rotors RX250 and RX400 are compatible with buckets B250 and B400 as well as lids L250 and L400		



Possible Configurations:

Loading the buckets	
<p>Allowed:</p>	<p>Forbidden :</p>
Loading the rotor	
<p><u>Allowed:</u> Symmetrical loading</p>	<p><u>Forbidden :</u> Incomplete loading Asymmetrical loading</p>

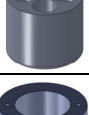
Accessories for NU-RX400

Buckets				
Part number :	NU-B400			
Description:	Round bucket 250 ml (Set of 4)			
Volume	400 ml			
Maximum capacity :	560 grams			
Lifetime	70,000 cycles 12 years			
Maximum Radius	180 mm			
Lid				
Part number:	NU-L400			
Description :	Airtight lid 400 ml (Set of 4)			
Inserts (Sets of 2 OR 4)				
Part number	Radius (*)	Capacity per insert	Total capacity (Rotor)	
NU-1T2	186 mm	30x Tubes 1.5-2 ml MicroTube	120	
NU-1T5	186 mm	15x Tubes 5/7 ml Round bottom	60	
NU-1T10 (**)	186 mm	12x Tubes 10 ml Round bottom 3x Tubes 15 ml CPT Round bottom	48 12	
NU-1T15C	188 mm	7x Tubes 15 ml Conical bottom	28	
NU-1T50L (**)	185 mm	4x Tubes 50 ml type Round bottom (***)	16	
NU-1T50CL	188 mm	3x Tubes 50 ml Conical bottom	12	
NU-1T50SL	186 mm	3x Tubes 50 ml Skirted bottom	12	
NU-1T50S	185 mm	4x Tubes 50 ml Skirted bottom (***)	16	
NU-1T200	188 mm	1x Bottle 175 ml Conical bottom 1x Bottle 225 ml Conical bottom	4	
	188 mm	1x Bottle 400 ml Conical bottom	4	No Insert Required

(*) The radius is the distance between the rotor shaft and the bottom of the inserts when the bucket is spinning in a horizontal position (during centrifugation)

(**) Same insert for many types of tubes.

(***) Can only be used without a lid



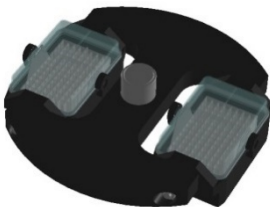

2.3 Swing-Out Rotor NU-RHDW

Rotor		
Part number:	NU-RHDW	
Description:	Microplate swing-out rotor	
Maximum capacity:	2x 4 96-well microplates 2x 1 96-well "Deep Well" plate	
Fastening:	ClickSpin system	
Maximum rotor speed	5100 rpm (With NU-BHDW buckets)	
Maximum centrifugal force of the rotor	4537 xg (With NU-BHDW buckets)	
Lifetime	30,000 cycles at maximum speed 6 years	
Centrifuge performance	Maximum speed	Maximum centrifugal force
NU-C200 Ventilated	4500 rpm	3531 xg
NU-C200 Refrigerated	5100 rpm	4537 xg

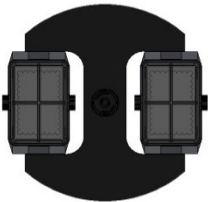

(Buckets and lids not included)

Possible Configurations:

Loading the buckets			
Allowed:		✓	Not allowed:
			
			✗
Loading the rotor:			
Allowed:	✓	Forbidden :	✗
Symmetrical loading		Incomplete loading	
		Asymmetrical loading	
			

Accessories for NU-RHDW

Buckets	
Part number:	NU-BH
Description:	Micro titration buckets (Set of 2)
Capacity standard Microplates	4 plates per bucket (total of 8)
Capacity Deep well blocks	1 block per bucket (total of 2)
Maximum capacity :	720 grams
Lifetime	30,000 cycles at maximum speed 6 years
Maximum radius :	156 mm
Included :	Neoprene pad (Set of 2)
	Stainless Steel Extractor (set of 2)
Lid	
Part number:	NU-LH
Description :	Airtight lid for Microplate (Set of 2)

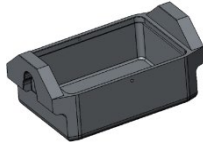











2.4 **Angle Rotor NU-RA24-2**

Rotor			 (Lid included)
Part number:	NU-RA24-2		
Description:	24 x 2 ml Angle rotor		
Maximum capacity:	24x 2 ml micro tubes		
Maximum load	24 x 10 gr		
Micro tube tilt:	45°		
Fastening:	ClickSpin system		
Maximum rotor speed	18000 rpm		
Maximum centrifugal force of the rotor	30980 xg		
Centrifuge performance	Maximum speed	Maximum centrifugal force	
NU-C200 Ventilated	15300 rpm	22380 xg	
NU-C200 Refrigerated	18000 rpm	30980 xg	
Maximum radius	86 mm		
Items included:	Airtight lid for NU-RA24-2		

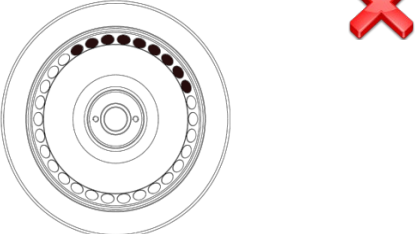

Possible Configurations:

Loading the rotor	
Allowed An Even number of tubes spaced evenly in the rotor. 	Forbidden: 

Accessories for NU-RA24-2

Lid		
Part number :	NU-LM1	
Description :	Airtight lid for rotors NU-RA24-2	

2.5 Angle Rotor NU-RA30-2

Rotor		 (Lid included)
Part number:	NU-RA30-2	
Description:	30 x 2 ml Angle rotor	
Maximum capacity:	30x 2 ml micro tubes	
Maximum load	30 x 10 gr	
Micro tube tilt:	45°	
Fastening:	ClickSpin system	
Maximum rotor speed	16000 rpm	
Maximum centrifugal force of the rotor	27720 xg	
Centrifuge performance	Maximum speed	
NU-C200 Ventilated	15300 rpm	25350 xg
NU-C200 Refrigerated	16000 rpm	27720 xg
Maximum radius	97 mm	
Items included:	Airtight lid for rotors NU-RA30-2 and NU-RA48-2	
		

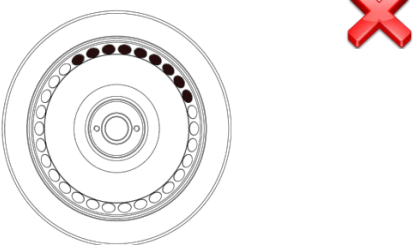

Possible Configurations:

Loading the rotor	
<p>Allowed</p> <p>An Even number of tubes spaced evenly in the rotor. </p>	<p>Forbidden:</p> 

Accessories for NU-RA30-2

Lid		
Part number:	NU-LM2	
Description:	Micro tube rotor airtight lid for rotors NU-RA30-2, NU-RA48-2 and NU-RA16-5	

2.6 Angle Rotor NU-RA48-2

Rotor		 <p>(Lid included)</p>
Part number:	NU-RA48-2	
Description:	48 x 2 ml Angle rotor	
Maximum capacity:	48x 2 ml micro tubes	
Maximum load	48 x 10 gr	
Micro tube tilt:	45°	
Fastening:	ClickSpin system	
Maximum rotor speed	15500 rpm	
Maximum centrifugal force of the rotor	26620 xg	
Centrifuge performance	Maximum speed	
NU-C200 Ventilated	14000 rpm	21720 xg
NU-C200 Refrigerated	15500 rpm	26620 xg
Maximum radius	99 mm (outer row) 89 mm (inner row)	
Items included:	Micro tube rotor airtight lid for rotors NU-RA30-2 and NU-RA48-2	
		

Possible Configurations:

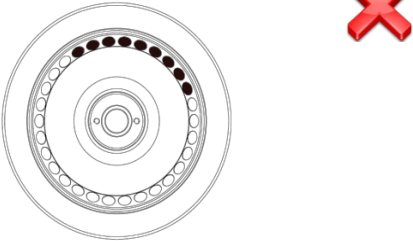
Loading the rotor	
<p>Allowed</p> <p>An Even number of tubes spaced evenly in the rotor. </p>	<p>Forbidden:</p> 

Accessories for NU-RA48-2

Lid		
Part number:	NU-LM2	
Description:	Micro tube rotor airtight lid for rotors NU-RA30-2, NU-RA48-2 and NU-RA16-5	

2.7 Angle Rotor NU-RA8-50

Rotor		
Part number:	NU- RA8-50	
Description:	8x 50 ml Angle rotor	
Maximum capacity:	8x 50 ml Conical tubes	
Maximum load	8 x 67 gr	
Micro tube tilt:	25°	
Fastening:	ClickSpin system	
Maximum rotor speed	12200 rpm	
Maximum centrifugal force of the rotor	16973 xg	
Centrifuge performance	Maximum speed	Maximum centrifugal force
NU-C200 Ventilated	12200 rpm	16973 xg
NU-C200 Refrigerated	12200 rpm	16973 xg
Maximum radius	102 mm	



2.8 Angle Rotor NU-RA16-5

Rotor		
Part number:	NU-RA16-5	
Description:	16 x 5 ml Angle rotor	
Maximum capacity:	16x 5 ml micro tubes	
Maximum load	16 x 36 gr	
Micro tube tilt:	45°	
Fastening:	ClickSpin system	
Maximum rotor speed	13200 rpm	
Maximum centrifugal force of the rotor	21000 xg	
Centrifuge performance	Maximum speed	Maximum centrifugal force
NU-C200 Ventilated	13200 rpm	21035 xg
NU-C200 Refrigerated	13200 rpm	21035 xg
Maximum radius	107.8 mm	
Items included:	Micro tube rotor airtight lid	



(Lid included)



Possible Configurations:

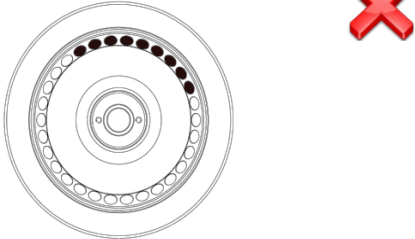

Loading the rotor	
<p>Allowed</p> <p>An Even number of tubes spaced evenly in the rotor. </p>	<p>Forbidden:</p> 

Accessories for NU-RA16-5

Lid	
Part number:	NU-LM2
Description:	Micro tube rotor airtight lid for rotors NU-RA30-2, NU-RA48-2 and NU-RA16-5



2.9 Angle Rotor NU-RA30-15

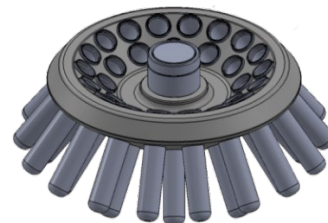

Rotor		
Part number:	NU-RA30-15	
Description:	30 x 15 ml Angle rotor	
Maximum capacity:	30x 15 ml micro tubes	
Maximum load	30 x 26 gr	
Micro tube tilt:	53°	
Fastening:	ClickSpin system	
Maximum rotor speed	5100 rpm	
Maximum centrifugal force of the rotor	4275 xg	
Centrifuge performance	Maximum speed	Maximum centrifugal force
NU-C200 Ventilated	4500 rpm	3328 xg
NU-C200 Refrigerated	5100 rpm	4275 xg
Maximum radius	140 mm	
Items included:	30 Tube holders	
	30 Wells for round bottom tubes	

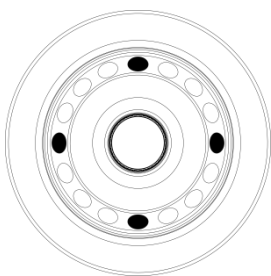
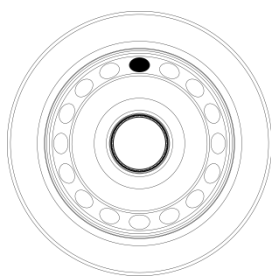

Possible Configurations :

Loading the rotor	
The rotor must be loaded evenly.	
<p>Allowed</p> 	<p>Forbidden: A load with number of odd tubes is prohibited for this rotor.</p> 

Accessories for NU-RA30-15

Cups		
Part Number:	NU-3015R	
Description:	15 ml round-bottomed tube cups (Set of 30)	
Part Number:	NU-3015C	
Description:	Tubes for 15 ml tubes with conical bottom (Set of 30)	
Tubes		
Part Number:	NU-3015S	
Description:	Tube holder for 15 ml round bottom tubes (Set of 30)	

2.10 Angle Rotor NU-RA6-100

Rotor		
Part number:	NU- RA6-100	
Description:	Angular Rotor 6x 100 ml	
Maximum capacity:	6x 100 ml Tube	
Maximum load	6x 135 grams	
Tube tilt:	28°	
Fastening:	ClickSpin system	
Maximum rotor speed	12100 rpm	
Maximum centrifugal force of the rotor	17351 xg	
Centrifuge performance	Maximum speed	Maximum centrifugal force
AFI-C200 Ventilated	10700 rpm	13568 xg
AFI-C200 Refrigerated	12100 rpm	17351 xg
Maximum radius	106 mm	

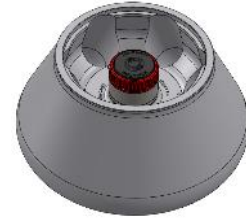

Configurations:

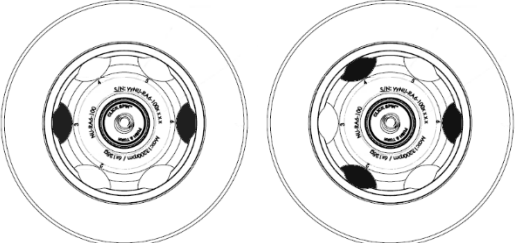
Loadings	
A rotor must be uniformly loaded.	
<p>Allowed: This rotor is not equipped with a lid. To maintain performance, all cells without exception must be equipped with a tube.</p> 	<p>Forbidden :</p> 

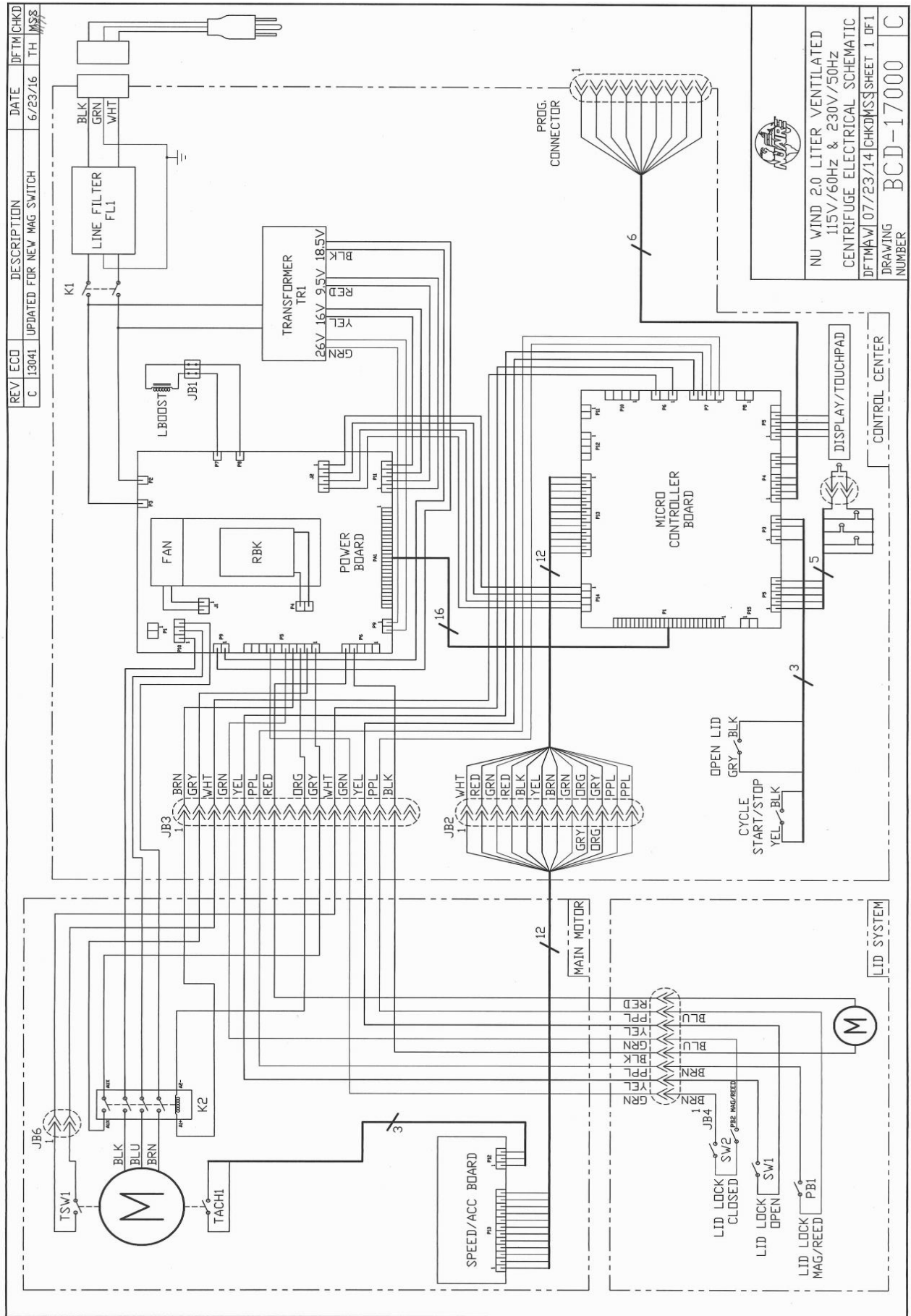

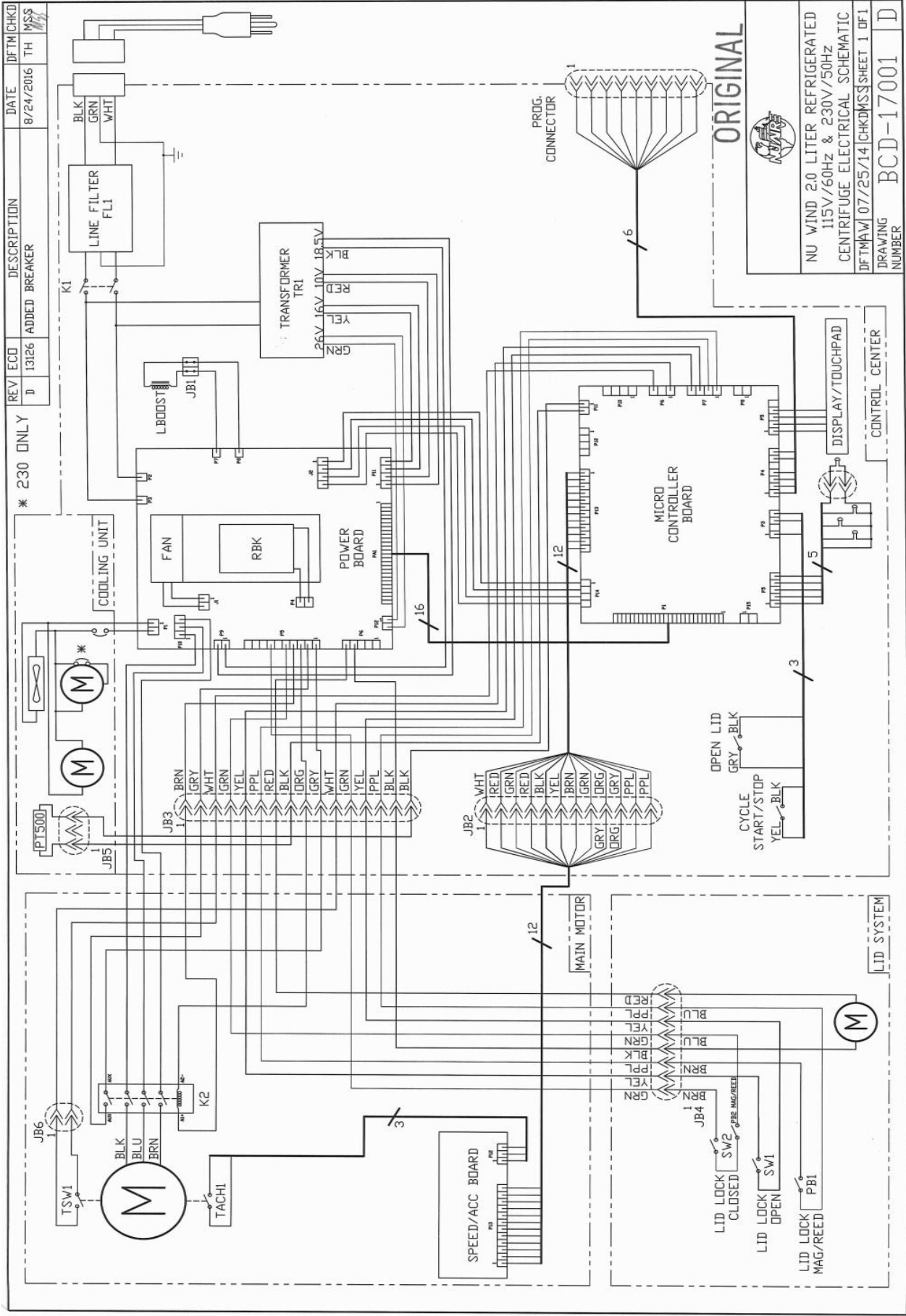

ORIGINAL



NU WIND 2.0 LITER REFRIGERATED
 115V/60Hz & 230V/50Hz
 CENTRIFUGE ELECTRICAL SCHEMATIC

DFTMAW 07/25/14 CHKD MSS SHEET 1 OF 1
 DRAWING NUMBER BCD-17001 D