



# VIVARIUM EQUIPMENT

The Safer Choice





## TABLE OF CONTENTS

The NuAire Advantage.....	1
Vivarium Equipment Basics.....	2
Animal Transfer Stations.....	8
Class I Animal Bedding Disposal Station.....	12
Animal Handling Biosafety Cabinets.....	14
NU-610 & Custom Solutions.....	16
Popular Options & Accessories.....	20
Complete Your Laboratory.....	21



# NUAIRE

## THE NUAIRE ADVANTAGE

In 1971, Max Peters designed his first Biosafety Cabinet (BSC) from inside his own garage at the behest of the National Institute of Health (NIH) in Bethesda, Maryland. The NIH put out a public purchase order (NIH-03-112c) for a machine that could protect the safety of scientific personnel and their research products. Peters helped establish some of the quality standards that all modern Biosafety Cabinets are held to this very day. After being awarded the NIH contract, a new laboratory equipment engineering and manufacturing company, NuAire, was born. Today, NuAire, Inc. is still owned and operated by the Peters family in Plymouth, MN.

For over half a century, NuAire has consistently led the industry in safety standards and customer satisfaction. We obsess over our customers' needs and tailor unique solutions to meet those needs. With invaluable input from customers like you, we now offer a wide range of biosafety cabinets, CO<sub>2</sub> incubators, restricted access barrier systems, animal handling workstations, ultralow temperature freezers, and custom solutions. With our cutting-edge robotic sheet metal facility, we are able to deliver you custom, innovative solutions in addition to the standard laboratory equipment that we sell.

NuAire, Inc. has now sold more than 100,000 Biosafety Cabinets in more than 150 countries, spanning across all seven of the world's continents. We pride ourselves on our products' industry leading quality, reliability, low cost of ownership, and environmental sustainability. Our quality management system is certified to adhere to ISO 9001:2015 and 13485:2016 requirements. Our products are also celebrated for their ergonomic design, ease of use, and quiet operation. All standard BSC units sold in the US and Canada come with a 5-year parts & labor warranty. Every one of our machines are built specifically to your order, so we can guarantee satisfaction.

As NuAire continues to grow, we are committed to continuously improving our products and expanding our offerings. We always strive to provide you with the optimum level of personnel, environmental, and product protection throughout any industry.

### NuAire's Quality Policy:

- Satisfy Customers
- Comply with System Requirements
- Continually Improve

**Choose NuAire as the Safer Choice for Your Vivarium.**

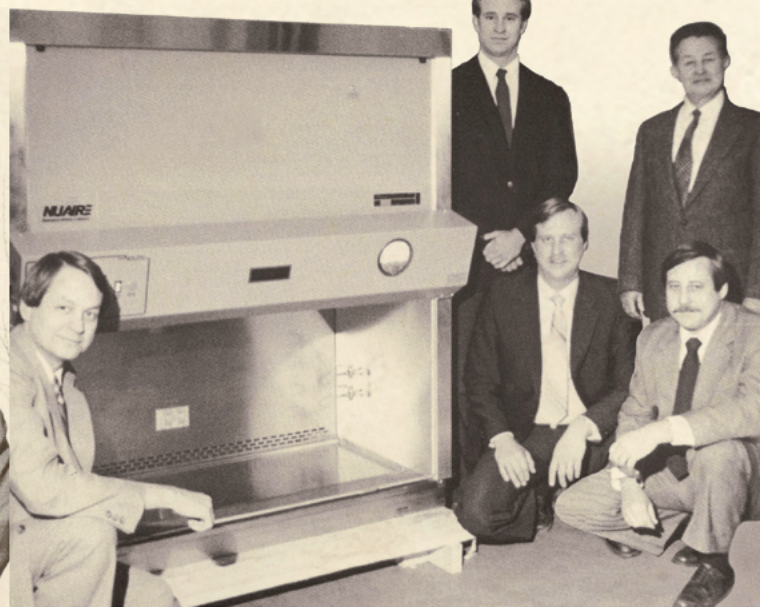

# WHAT'S THE DIFFERENCE?

## Biosafety Cabinets

A Biosafety Cabinet (BSC) is an enclosed laboratory workspace for safely handling potentially contaminated or hazardous materials requiring a predefined level of biosafety. Because of the increased protection granted by a BSC, personnel can practice procedural tasks in the work zone, such as injecting, manipulating, or examining the product. Three different classes (I, II, or III) of BSCs currently exist, defined by the degree of biocontainment required. Multiple types also exist within class II cabinets, dictated by what proportion of the air passing through the work zone gets exhausted versus recirculated. The higher level of containment granted by a BSC protects animals that may be immuno-compromised, biohazardous, or designated with unknown infection status. Unlike traditional BSCs designed for microbiology, animal handling models accommodate the specific needs of animal researchers by adding unique modifications, such as pre-filters, built-in waste chutes, and/or cage pass-through ports.

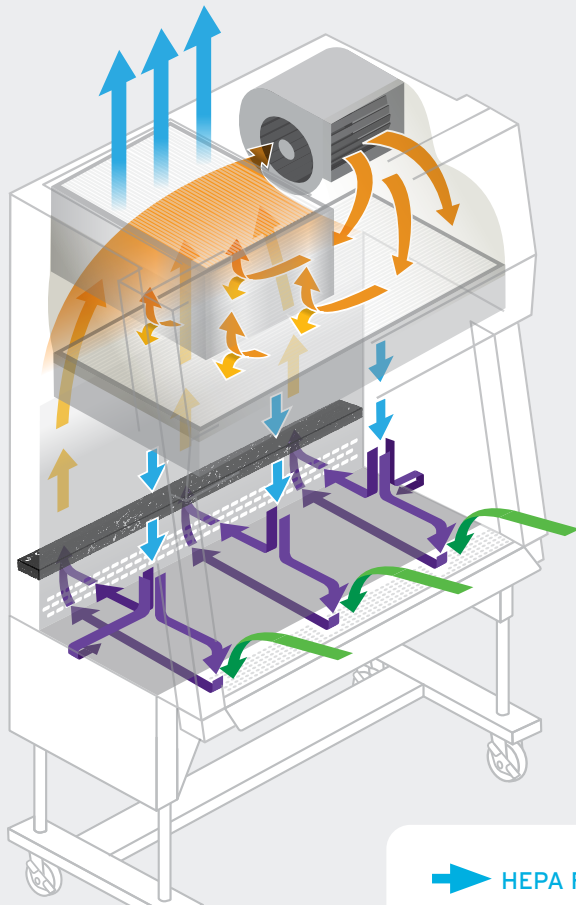

Class II Type A2 Biosafety Cabinet Airflow Dynamics

- ▶ HEPA Filtered Air
- ▶ Contaminated Work Zone Air
- ▶ Contaminated Room Air
- ▶ Pre-filtered Work Zone Air

## Animal Transfer Stations

Animal Transfer Stations (ATS) are clean air workstations specifically designed to accommodate changing of cages for non-infected animals only. ATS models are designed for transferring animals from dirty to clean cages and are not intended for procedural work, such as injecting, handling, and/or examinations. They do provide protection against most allergens but do not protect personnel against exposure to infectious agents. The ATS workspace can be accessible from one or two sides, depending on the intended usage. Typically, one-sided stations create a stronger air barrier than their dual-sided counterparts, while two-sided models offer greater convenience. The opening sash levels can be higher than biosafety cabinets, allowing for large cages to be moved in and out of the work zone with ease. ATS units typically occupy a smaller footprint and can be conveniently moved between rooms. The versatility of these devices make them optimal for widespread, low-risk workflows throughout the vivarium.

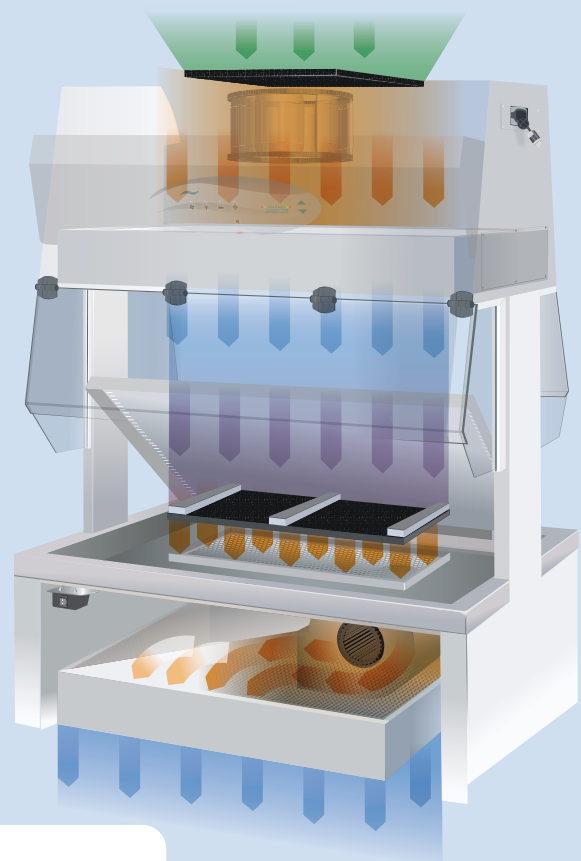

Dual-Sided Animal Transfer Station Airflow Dynamics

## BSC AIRFLOW DYNAMICS



**true laminar**

True laminar downward moving air, utilized in class II BSCs, flushes the work surface at 60 fpm (0.30 m/s), minimizing cross-contamination within the work zone.

*dynamic*  
**air** barrier

Class II BSCs create a dynamic air barrier at the front of the cabinet, which separates the laboratory from the work zone at a constant inflow speed of 105 fpm (0.53 m/s).

## ATS AIRFLOW DYNAMICS

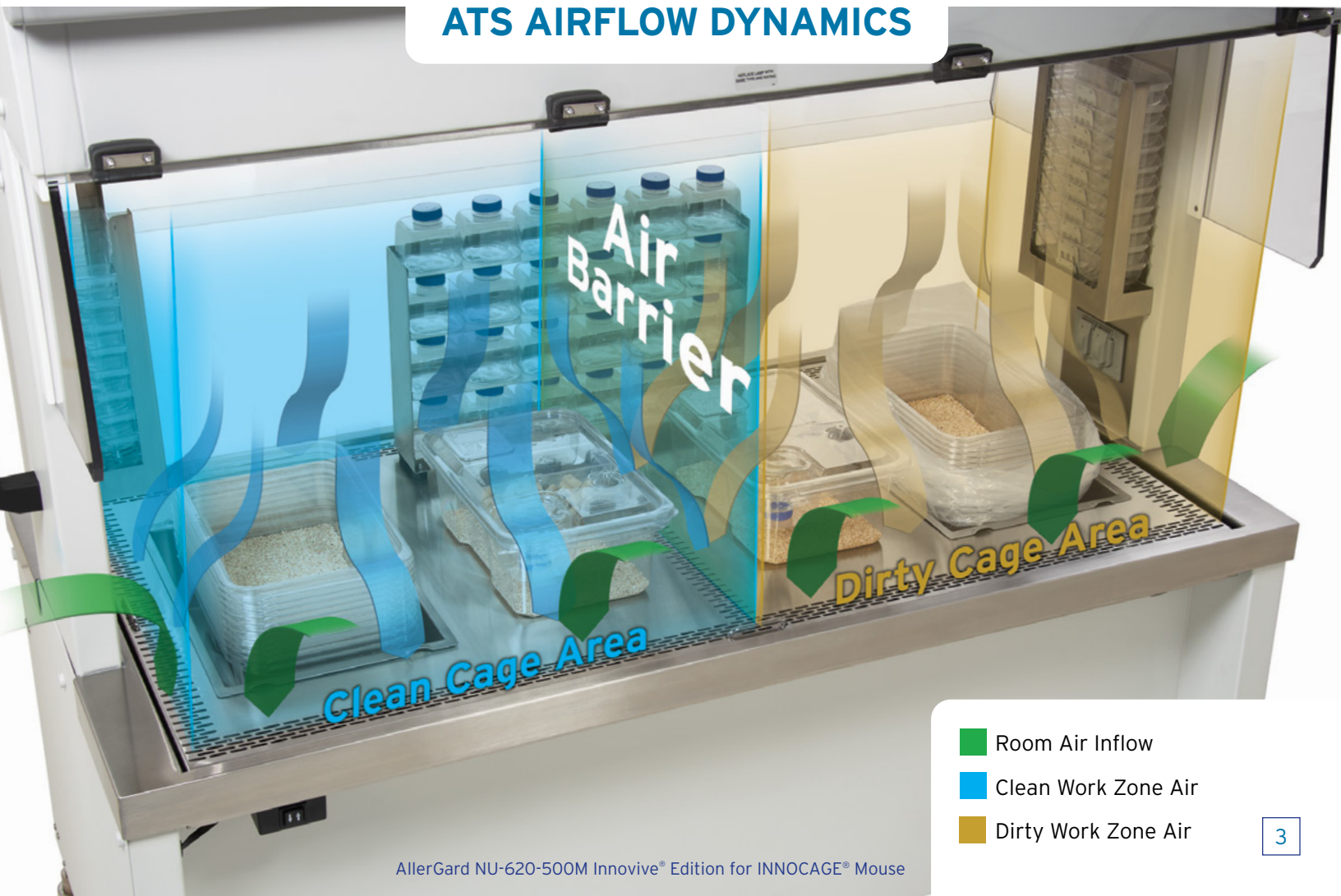

- Room Air Inflow
- Clean Work Zone Air
- Dirty Work Zone Air

# ERGONOMIC DESIGN

NuAire Laboratory Equipment boasts superior ergonomics without compromising on safety.

Technicians spend several hours sitting or standing in front of their workstation; this makes all day comfort a necessity. Our engineers' designs specifically reduce arm, shoulder, and neck strain that often contributes to workplace injuries.

## ATS Ergonomic Options & Features:

- Deep cage well(s) to allow more stacked cages
- Electric auto-lift to adjust work surface height with up to 12" [305 mm] of range at the touch of a button
- 14" [356 mm] hinged access opening height on one or both sides of the workstation
- Zero heat build up in the work area; over 25 air changes per minute in the work zone
- Cool LED lighting from the top of the workstation improves visibility and reduces eye strain
- Side-mounted, foldable stainless steel shelf
- Heavy-duty casters to conveniently move from room to room throughout the vivarium
- Push/pull bars to conveniently move around the lab



AllerGard NU-620-500M  
Animal Transfer Station

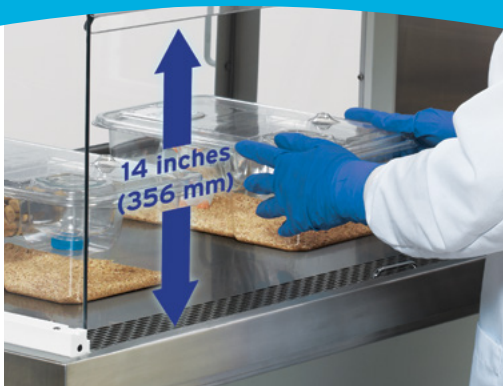

**Large 14" (356 mm) access opening** makes it easy to add and remove the largest cages while providing your arms an extended range of motion



**A spacious work zone** offers more room to work with cages, feeders, water bottles, and other supplies



**A slanted polycarbonate sash** provides unrestricted view of the work zone while reducing glare

### BSC Ergonomic Options & Features:

- Easy-to-use sliding or hinged access window
- Recessed airfoil grill to allow users to rest their arms without obstructing airflow intake
- Centrally located control panel for reduced reach
- Motorized auto-lift with up to 18.5" [470 mm] of range at the touch of a button
- Up to 14" [356 mm] access opening height
- Cool LED lighting from the top of the work zone improves visibility and reduces eye strain
- Push/pull bars to conveniently move around lab
- Integrated or movable footrests and elbow rests
- Feed hoppers and/or water bottle stands can be added to the work zone to reduce repetitive arm movements



LabGard LP NU-640  
Class II Biosafety Cabinet



# EASIER ON YOUR PERSONNEL

NuAire animal handling equipment maximize cleanability and minimize unit downtime without compromising on safety. All interior work surface corners are made from a single piece of stainless steel or clear polycarbonate sheets to eliminate the need for silicone sealant, a common area for contamination. The removable, stainless steel work tray comes standard with an integrated prop-up stand for easy access to the internal basin/trough. The mesh pre-filter can be easily removed for routine cleaning or replaced entirely.

All service functionality can be accessed from the front drop-down control panel to help facilitate routine service and maintenance for technicians/certifiers. Control panel electrical components are also conveniently located inside the front drop-down panel.

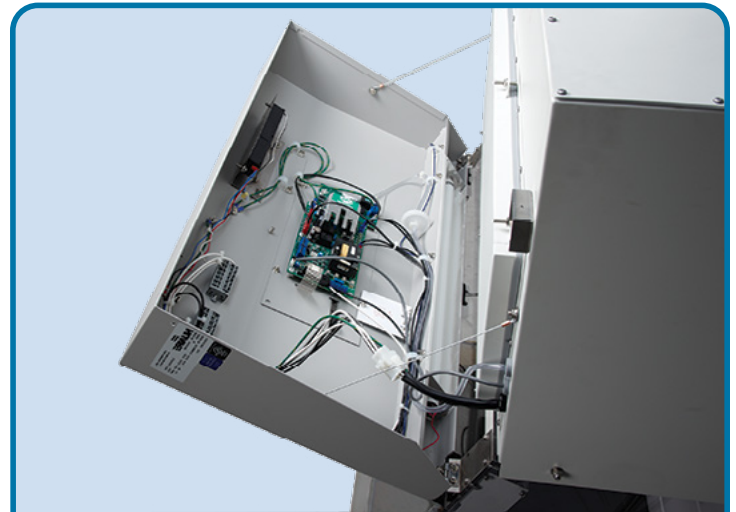

## Drop-Down Control Panel

Electronic, lighting, and filter components are easily accessible through the hinged front control panel.



Extra-large hinged/sliding front access viewing window, so you can comfortably reach each corner of the work zone while cleaning.

LabGard LP NU-640 Class II Biosafety Cabinet

Washable mesh pre-filter to capture large particles and prop-up work tray to easily clean the internal basin/trough comes standard with every animal handling biosafety cabinet.

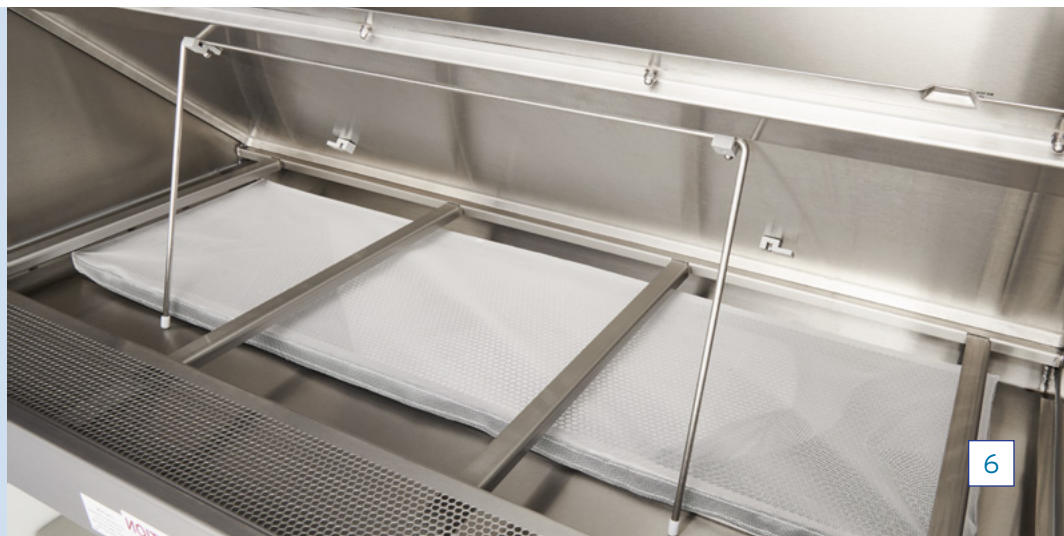

LabGard LP NU-640 Class II Biosafety Cabinet



# AEROMAX CONTROL CENTER

The AeroMax™ Control System is a simplified control system that monitors and displays airflow status via our single PressureFlow™ sensor - a specialized digital pressure transducer. The control panel also notifies lab workers with both visual and audio alarms if the unit's airflow pressure departs significantly from its set point. The user interface is operated through a series of buttons and LED indicators, which control the unit's DC ECM blower(s) / impeller(s), UV light, and outlets.

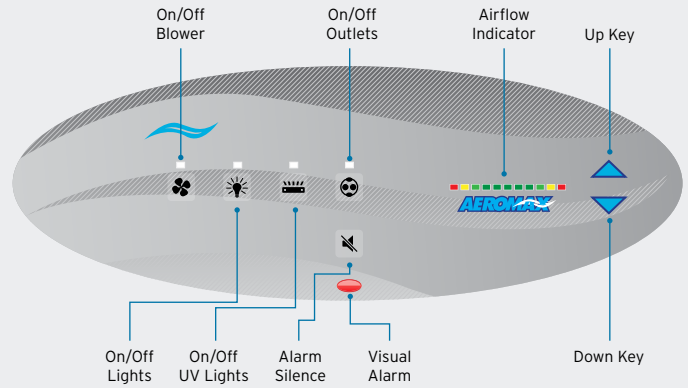

# SUSTAINABILITY

## Ultra-High Efficiency DC ECM Blower

NuAire utilizes an ultra-high efficiency DC ECM blower with forward facing fan blades and/or DC impellers to reduce overall energy consumption. It provides enough power to compensate for HEPA filter loading, reducing filter changes and lowering the total ownership cost.\*

\*DC ECM is not available on NU-620 Innovive® models.

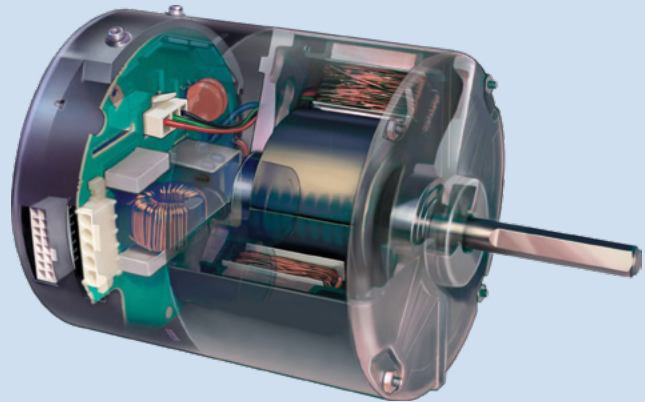

## Total Cost of Ownership Breakdown.

Motor Comparison	NuAire DC ECM	NuAire AC PSC	BSC with AC 3-Phase	BSC with DC
<b>8 hrs per day / 5 days per week = 2,000 hrs per year</b>				
KWH per year	598	1128	828	326
\$0.09/kwh	\$54	\$102	\$75	\$29
<b>24 hrs per day / 7 days per week = 8,736 hrs per year</b>				
KWH per year	2612	4927	3617	1424
\$0.09/kwh	\$235	\$443	\$326	\$128
<b>15 Year Life Cycle Costs</b>				
Avg. Filter Changes*	1 Set	2 Sets	1 Set	3 Sets
Estimated Cost of HEPA Filters	\$715	\$1,430	\$715	\$2,145
Total Cost of Decon/Certification	\$450	\$900	\$450	\$1,350
Motors to Replace**	1 Motor	1 Motor	1 Motor	2 Motors
Cost of Motors/ Power Supplies/ Fan Control	\$650	\$420	\$725	\$2,544
Utility Costs (2,000 hrs/yr over 15 years)	\$810	\$1,530	\$1,125	\$435
<b>Total Cost of Ownership</b>	<b>\$2,625</b>	<b>\$4,280</b>	<b>\$3,015</b>	<b>\$6,474</b>

\* estimate based on filter load capacity

\*\* estimate based on historical information.

Disclaimer: This example is for illustrative purposes only and should not be deemed a representation of future performance or a guarantee of any kind. Information is based on internal performance data obtained through NuAire testing and information provided by motor, blower, HEPA filter manufacturers, and independent service technicians.

# ALLERGARD<sup>ES</sup>

NU-620 DUAL-SIDED ANIMAL TRANSFER STATION

The AllerGard™ NU-620 Dual-Sided Animal Transfer Station (ATS) provides flexibility to vivariums with little space to maneuver. The NU-620 utilizes laminar downflow at 60 fpm (0.3 m/s) and perimeter inflow of 25 fpm (0.13 m/s) to provide allergen containment.

## Standard Features:

- Removable Prop-Up Work Tray for Easy Cleanability
- Motorized Auto-Lift Base Stand for Ergonomic Comfort
- Supply & Exhaust Mesh Pre-Filters, Easy to Remove and Clean
- 14" [356 mm] Hinged Access Opening, Easily Fits Large Cages
- Side-Mounted Push/Pull Handle Bars for Convenient Handling
- AeroMax™ Control Center with Pressure Monitor & Audible Alarm
- Electrical Outlet Mounted on the Inside Right Sidewall
- 4" [127 mm] Locking Casters for Extra Mobility
- ISO Class 4 Air Protection



# ALLERGARD<sup>ES</sup>

NU-621 SINGLE-SIDED ANIMAL TRANSFER STATION



The AllerGard™ NU-621 Single-Sided Animal Transfer Station offers improved allergen protection by creating a dynamic air barrier of 75 fpm (0.38 m/s) at the front of the workstation. The HEPA filtered laminar downflow air of 60 fpm (0.30 m/s) maintains aseptic conditions within the work zone.

## Standard Features:

- Removable Prop-Up Work Tray for Easy Cleanability
- Motorized Auto-Lift Base Stand for Ergonomic Comfort
- Supply & Exhaust Mesh Pre-Filters, Easy to Remove and Clean
- 14" [356 mm] Hinged Access Opening, Easily Fits Large Cages
- Side-Mounted Push/Pull Handle Bars for Convenient Handling
- AeroMax™ Control Center with Pressure Monitor & Alarm
- Electrical Outlet Mounted on the Inside Right Sidewall
- 4" [127 mm] Locking Casters for Extra Mobility
- ISO Class 4 Air Protection

# NU-620 / NU-621 Specifications

Model #	NU-620	NU-621
Nominal Widths	3, 4, 5 ft [0.9, 1.2, 1.5 m]	
Work Zone Dimensions (W x D x H)	36.6 - 54.6 x 28.3 x 25.5 in [929 - 1387 x 718 x 648 mm]	
Exterior Dimensions (W x D x H)	48 - 66 x 30.6 x 80.5 - 92.5 in [1220 - 1677 x 777 x 2045 - 2350 mm]	
Net Weight	430 - 530 lbs [195 - 240 kg]	
Certifications	UL listed, CE, UKCA	
Access Opening / Type	Dual-Sided 14 in [356 mm] / Hinged	Single-Sided 14 in [356 mm] / Hinged
Electrical	115 VAC / 60 Hz   230 VAC / 50-60 Hz	
Filter Load Capacity	150%	
Airflow Dynamics	25 fpm [0.13 m/s] Inflow, 60 fpm [0.30 m/s] Downflow	75 fpm [0.38 m/s] Inflow, 60 fpm [0.30 m/s] Downflow
	ISO Class 4 Air Protection	
Supply Filter	3 in [76 mm] HEPA 99.99% Efficient @ 0.3 microns	
Pre-Filter	Two (2) Washable or Disposable Mesh Pre-Filters	
Exhaust Filter	3 in [76 mm] HEPA 99.99% Efficient @ 0.3 microns	
Control System	Aeromax™ w/ PressureFlow™ Pressure Monitor	
Lighting	LED	
	Red (custom)	
Construction	Removable Stainless Steel Prop-Up Work Tray	
	Side-Mounted Push/Pull Bars	
	Stainless Steel Spill Trough	
	Attenuomont™ Vibration Control Support System	
	Electrical Outlet (Side-Wall Mounted)	
	Window Sash Magnifying Glass	
	Mounted Hand Sanitizer Dispenser	
	Stainless Steel Folding Shelf	
Animal Feed Hoppers		
Integrated Base Stand	Motorized Adjustable Hydraulic Base Stand	
Standard Feature		Optional Feature

60 fpm Downflow (0.30 m/s)

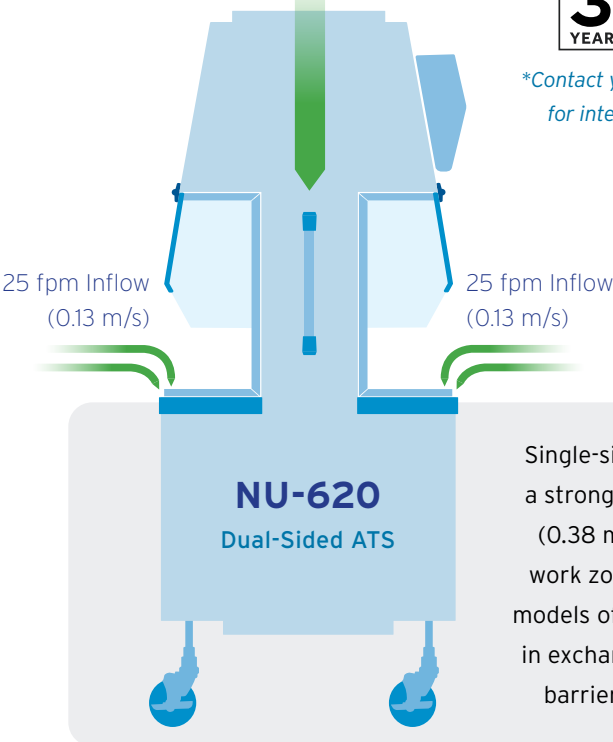

**3** YEAR WARRANTY  
PARTS + LABOR  
United States & Canada

\*Contact your local NuAire distributor for international warranty details.

60 fpm Downflow (0.30 m/s)

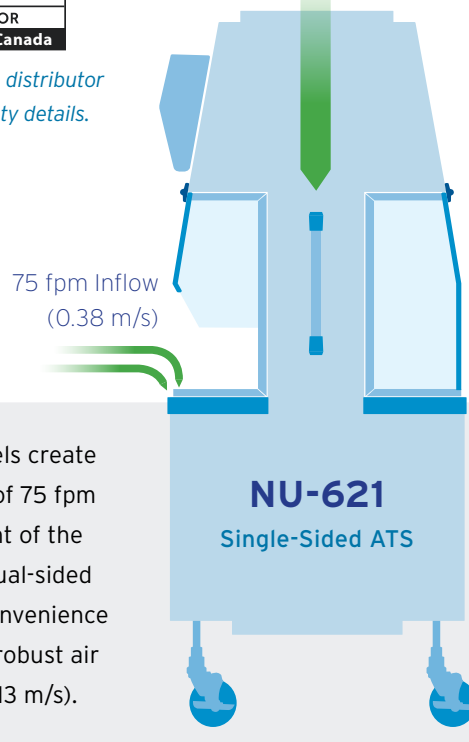

Single-sided ATS models create a stronger air barrier of 75 fpm (0.38 m/s) at the front of the work zone, whereas dual-sided models offer greater convenience in exchange for a less robust air barrier of 25 fpm (0.13 m/s).

# ALLERGARD<sup>ES</sup>

NU-620 INNOVIVE<sup>®</sup> EDITION ANIMAL TRANSFER STATION



The AllerGard NU-620M is designed specifically to accommodate Innovive<sup>®</sup> disposable mouse cages while employing similar airflow mechanics as our other dual-sided models, by flushing the work zone with a vertical “piston of air” to preserve aseptic conditions.

## Standard Features:

- Removable Prop-Up Work Tray for Easy Cleanability
- Motorized Auto-Lift Base Stand for Ergonomic Comfort
- Supply & Exhaust Mesh Pre-Filters, Easy to Remove and Clean
- 14” [356 mm] Hinged Access Opening, Easily Fits Large Cages
- AeroMax™ Control Center with Pressure Monitor & Alarm
- Up to Two Innovive<sup>®</sup> Mouse Cage Wells Built into Work Surface
- Electrical Outlet Mounted on the Inside Right Sidewall
- 6” [152 mm] Locking Casters for Extra Mobility
- Magnifying Glass Built into Viewing Window
- Side-Mounted Stainless Steel Folding Shelf
- ISO Class 4 Air Protection

The AllerGard™ NU-620R is designed for larger Innovive<sup>®</sup> rat cages while utilizing similar mechanics as our other dual-sided ATS models, which creates a vertical “piston of air” throughout the work zone to preserve aseptic conditions.

## Standard Features:

- Removable Prop-Up Work Tray for Easy Cleanability
- Motorized Auto-Lift Base Stand for Ergonomic Comfort
- 14” [356 mm] Hinged Access Opening, Easily Fits Large Cages
- Supply & Exhaust Mesh Pre-Filters, Easy to Remove and Clean
- AeroMax™ Control Center with Pressure Monitor & Alarm
- Electrical Outlet Mounted on the Inside Right Sidewall
- One Innovive<sup>®</sup> Rat Cage Well Built into Work Surface
- 6” [152 mm] Locking Casters for Extra Mobility
- Magnifying Glass Built into Viewing Window
- Side-Mounted Stainless Steel Folding Shelf
- ISO Class 4 Air Protection



# NU-620M / NU-620R Specifications

Model #	NU-620M	NU-620R
Nominal Widths	4, 5 ft [1.2, 1.5 m]	5 ft [1.5 m]
Work Zone Dimensions (W x D x H)	42.6 - 54.6 x 28 x 25.5 in [1082 - 1386 x 711 x 648 mm]	54.6 x 28 x 25.5 in [1386 x 711 x 648 mm]
Exterior Dimensions (W x D x H)	(54 - 66) x 30.75 x 78.1 - 90.1 in [1372 - 1676 x 780 x 1983 - 2289 mm]	66 x 30.75 x 78.1 - 90.1 in [1676 x 780 x 1983 - 2289 mm]
Net Weight	460 - 530 lbs [209 - 240 kg]	
Certifications	UL listed, CE, UKCA	
Access Opening / Type	Dual-Sided 14 in [356 mm] / Hinged	
Electrical	115 VAC / 60 Hz   230 VAC / 50-60 Hz	
Filter Load Capacity	150%	
Airflow Dynamics	25 fpm [0.13 m/s] Inflow, 80 fpm [0.38 m/s] Downflow ISO Class 4 Air Protection	
Supply Filter	6 in [152 mm] HEPA 99.99% Efficient @ 0.3 microns	
Pre-Filter	Two (2) Washable or Disposable Mesh Pre-Filter	
Exhaust Filter	6 in [152 mm] HEPA 99.99% Efficient @ 0.3 microns	
Control System	Aeromax™ w/ PressureFlow™ Pressure Sensor	
Lighting	LED Red (custom)	
Construction	Removable Stainless Steel Prop-Up Work Tray	
	Side-Mounted Push/Pull Bars	
	Stainless Steel Spill Trough	
	1-2 Mouse Cage Deep Well(s)	One (1) Rat Cage Deep Well
	1 Electrical Outlet (Side-Wall Mounted)	
	Animal Feed Holders	
	Window Sash Magnifying Glass	
	Stainless Steel Folding Shelf	
Integrated Base Stand	Mounted Hand Sanitizer Dispenser	
	Motorized Adjustable Hydraulic Base Stand	

Standard Feature

Optional Feature



*\*Contact your local NuAir distributor for international warranty details.*

## NU-S620-400M

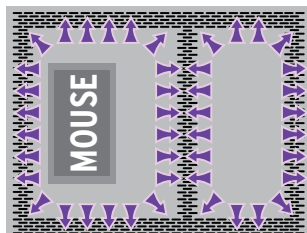

## NU-S620-500M

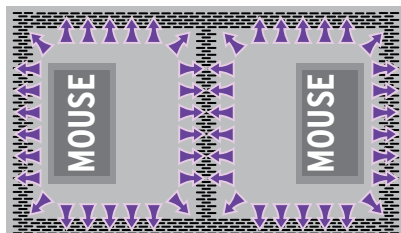

## NU-S620-500R

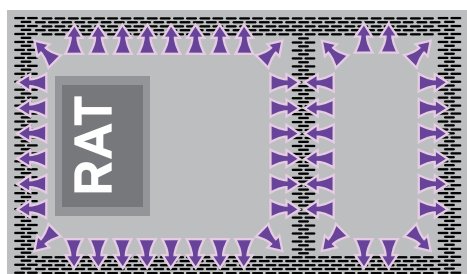

NU-620M/R Animal Transfer Station Work Surface & Airflow Dynamics

- HEPA Filtered Air
- Contaminated Work Zone Air
- Contaminated Room Air
- Pre-filtered Work Zone Air

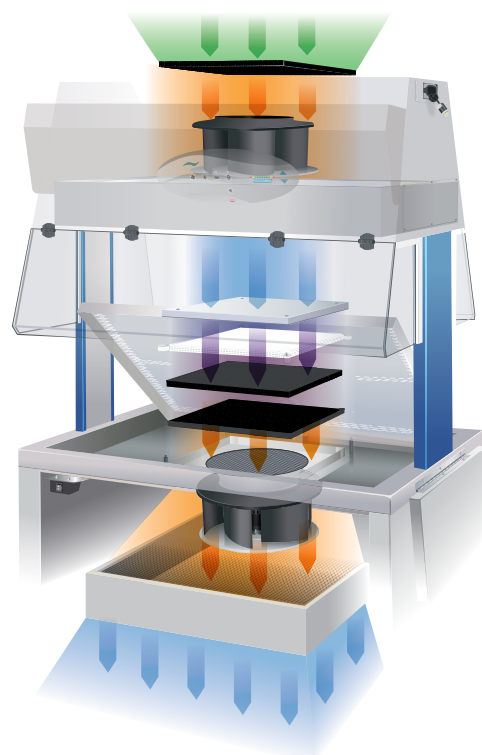

NU-S620 Animal Transfer Station Airflow Dynamics

The Allergard ES NU-608 Class I Animal Refuse Workstation minimizes the risk of exposure to allergens and animal infections when handling low to moderate risk materials. Cleaning out cages and handling infested animal bedding may not be the most glamorous task, but the NU-608 makes it convenient, safe, and efficient.

## Standard Features:

- Constant 105 FPM [0.53 m/s] Inflow Air Barrier
- AeroMax™ Control Center with Pressure Monitor & Alarm
- Integrated Prop-Up Work Tray & Waste Chute
- Easy Bag Attachment to Waste Chute
- Stainless Steel Bang Bar Over Waste Chute
- Adjustable Telescoping Base Stand
- Deodorizing Charcoal Exhaust Filter
- Extra Large 14" [356 mm] Hinged Access Opening
- Easy-to-Clean Stainless Steel Work Surface
- 4" [127 mm] Locking Casters for Extra Mobility
- 20 Gallon [76 Liter] Waste Bin w/ Caster Platform
- Side-Mounted Push/Pull Handle Bars



personnel &  
environmental  
protection



Stainless steel bang bar ensures waste gets successfully dumped into chute.



Extra large 14 in [356 mm] access opening comfortably fits rat cages.

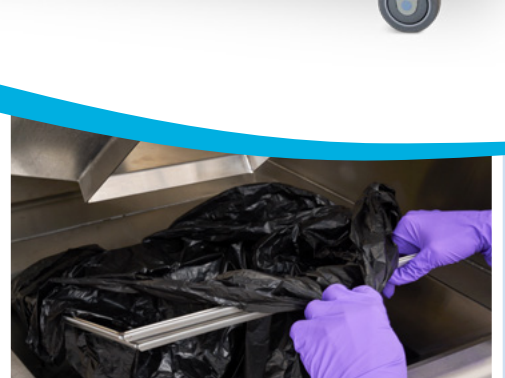

Easily attach garbage bag to waste chute. No tools necessary!

# Class I Animal Refuse Workstation

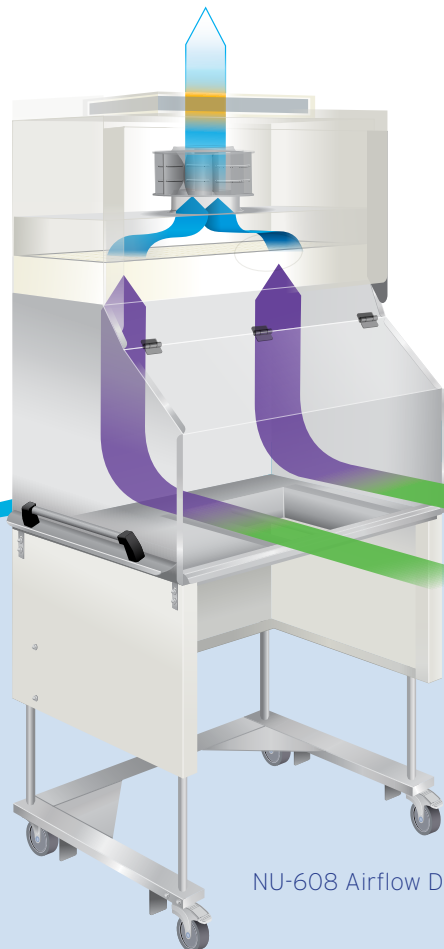

Model #	NU-608-400
Cabinet Style	Console w/ Integrated Base
Nominal Width	4 ft [1.2 m]
Workspace Dimensions (W x D x H)	46.25 x 29.75 x 28 in [1174 x 756 x 711 mm]
Exterior Dimensions (W x D x H)	52.75 x 33.375 x (84.75 - 96.75) in [1340 x 848 x (2153 - 2457) mm]
Net Weight	400 lbs [181 kg]
Performance Standards	UL listed, ADA Compliant
Access Opening	14 in [356 mm]
Electrical Requirements	115 VAC / 60 Hz 230 VAC / 50-60 Hz
Air Barrier	105 fpm [0.53 m/s] Inflow
Filter Type	6 in [152 mm] Single HEPA 99.99% @ 0.3 micron Efficiency
Exhaust Module	C-25 Charcoal Exhaust Filter Module
Control System	AeroMax™ w/ PressureFlow™ Monitor
Lighting	LED
Noise Level	Up to 62 dba
Construction	Removable Stainless Steel Air Foils
	Single Rectangular Disposal Chute w/ Stainless Steel Bang-Bar
Base Stand Options	Telescoping Base Stand w/ Casters
	Motorized Base Stand w/ Casters
Standard Feature	
Optional Feature	



NU-608 Airflow Dynamics

**3** YEAR WARRANTY  
PARTS + LABOR  
United States & Canada

*\*Contact your local NuAire distributor for international warranty details.*

-  HEPA Filtered Air
-  Contaminated Work Zone Air
-  Contaminated Room Air



Pneumatic chute lift for easy bag changing.



environmental,  
product & personnel  
protection

## Big Cage? Small Lab? No Problem.

The LabGard® ES LP (Low Profile) NU-640 Class II, Type A2 Animal Handling Biosafety Cabinet provides the largest work access opening with the smallest footprint while offering enough versatility to assist with all facets of the vivarium workflow. The 105 fpm [0.53 m/s] inflow combined with 60 fpm [0.30 m/s] true laminar downflow creates the dynamic air barrier. The nominal 6 foot [1.8 m] wide cabinet allows the ability to mix and match custom configurations such as a cage pass-through port and/or integrated refuse disposal system.

### Standard Features:

- Single Mesh Pre-Filter, Easy to Remove, Clean, and Reuse
- 14" [356 mm] Hinged Access Opening, Easily Fits Rat Cages
- Superior Ergonomics, Comfortably Reach In & Around Work Zone
- Motorized Auto-Lift Base Stand with Built-In Footrest
- Work Surface Height Range of 35" to 43" [889 to 1092 mm]
- Work Tray Prop-Up Bar for Easy Cleanability
- Low Profile; Compatible with Low-Hanging Ceilings
- AeroMax™ Control Center with Pressure Monitor & Audible Alarm
- 250% HEPA Filter Loading Capacity (≈10 Year Lifespan)
- 5" [127 mm] Heavy-Duty Casters for Extra Mobility
- ISO Class 5 Air Protection

### Compatible with Low Ceilings

56.375-80.375" [1433-2042 mm]  
Unit Width (w/ Pull Bars)

33" [838 mm]  
Unit Depth

78.25-86.25"  
[1988-2191 mm]  
Unit Height

14" [356 mm]  
Sash Height

35-43" [889-1092 mm]  
Work Surface Height

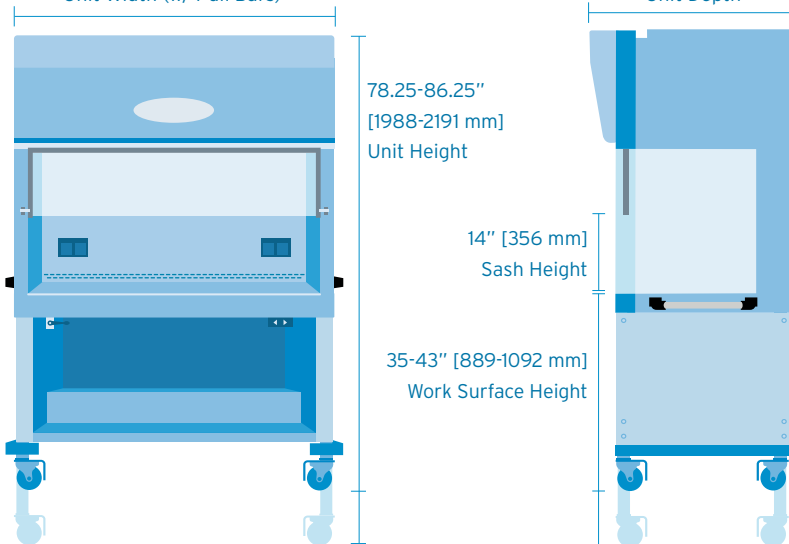

**Fits Through Standard Doorways**

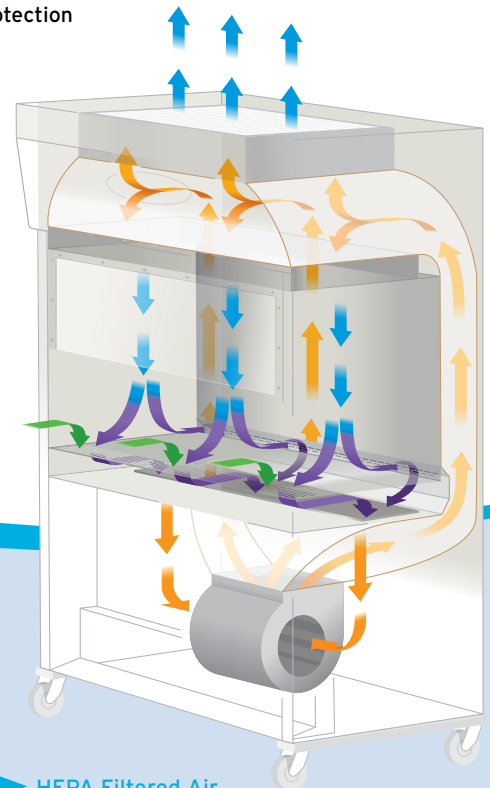

- ➡ HEPA Filtered Air
- ➡ Contaminated Work Zone Air
- ➡ Contaminated Room Air
- ➡ Pre-filtered Work Zone Air



# NU-640 Specifications

Class, Type, Style	Class II, Type A2, Console		
Model #	NU-640-400	NU-640-500	NU-640-600
Nominal Widths	4 ft [1.2 m]	5 ft [1.5 m]	6 ft [1.8 m]
Work Zone Dimensions (W x D x H)	46.5 x 22.75 x 24.625 in [1181 x 578 x 626 mm]	58.5 x 22.75 x 24.625 in [1486 x 578 x 626 mm]	70.5 x 22.75 x 24.625 in [1791 x 578 x 626 mm]
Exterior Dimensions (W x D x H)	56.375 x 33 x (78.25-86.25) in [1433 x 838 x (1987-2190) mm]	68.375 x 33 x (78.25-86.25) in [1737 x 838 x (1987-2190) mm]	80.375 x 33 x (78.25-86.25) in [2042 x 838 x (1987-2190) mm]
Net Weight	560 lbs [254 kg]	650 lbs [295 kg]	740 lbs [336 kg]
Certifications	UL listed, CE, UKCA		
Access Opening / Type	14 in [356 mm] / Hinged		
Electrical	115 VAC / 60 Hz   230 VAC / 50-60 Hz		
Filter Load Capacity	250%		
Air Barrier	105 fpm [0.53 m/s] Dynamic Inflow, 60 fpm [0.30 m/s] True Laminar Down Flow ISO Class 5 Air Protection		
Supply Filter	3 in [76 mm] HEPA 99.99% Efficient @ 0.3 microns		
Pre-Filter	Animal Hair / Dander Pre-Filter		
Exhaust Filter	6 in [152 mm] HEPA 99.99% Efficient @ 0.3 microns		
Control System	Aeromax™ w/ PressureFlow™ Pressure Sensor		
Lighting	LED		
Password Protection	Yes		
Noise Level	Up to 67 dba		
Construction	Coved Interior Corners		
	Side-Mounted Push/Pull Bars		
	Two (2) Back-Wall Electrical Outlets		
	Removable Stainless Steel Easy-to-Clean Prop-Up Flat Work Tray		
	Permanent Positive Pressure Plenum w/ Quick Release Supply Filter Removal		
	AttenuMont™ Vibration Control Support System		
	16/18 gauge Stainless Steel Welded Construction		
	Stainless Steel Spill Trough w/ Drain Valve		
	Attachable Stainless Steel Armrest		
	Stainless Steel Window Edge Protector		
	Up to Three (3) Service Valves/Couplings (Right/Left Sidewalls)		
	Dirty Cage Collection Bin w/ Exterior Sidewall Mounted Shelf (Custom)		
Integral Base Stand	Built-In Waste Disposal System (Custom)		
	Motorized Adjustable Base Stand w/ Built-In Footrest		
Popular Accessories	Exhaust Canopy		
	Butterfly Dampeners		
	Flex Duct		
	Cushioned Movable Elbow Rests		

Standard Feature

Optional Feature

## Standard Features



**5 YEAR WARRANTY**  
PARTS + LABOR + FILTERS  
United States & Canada

\*Contact your local NuAire distributor for international warranty details.



The LabGuard<sup>®</sup> ES (Energy Saver) Model NU-677 Class II Type A2 Biosafety Cabinet/Cage Changing Station is NSF/ANSI 49 listed to provide personnel, product, and environmental protection for sensitive animal handling and cage changing procedures. The NU-677 can be exhausted back into the lab or connected to a facility HVAC system. The NSF-approved 12" [305 mm] access opening accommodates most large mouse and rat cages. The NU-677 comes standard with our mechanical auto-lifting base stand, which allows extra flexibility to help avoid repetitive stress injuries and ensure you stay comfortable throughout your entire work day. The included base stand comes standard with heavy-duty caster wheels to allow for extra mobility.



environmental,  
product & personnel  
protection

-  HEPA Filtered Air
-  Contaminated Work Zone Air
-  Contaminated Room Air
-  Pre-filtered Work Zone Air

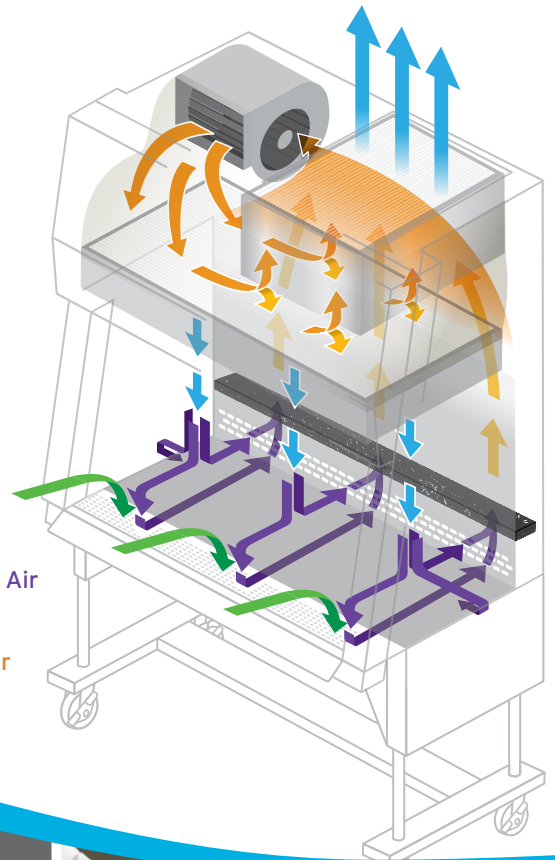

An optional waste bin can be installed into the work surface for safe and convenient disposal.



Deep cage wells can also be optionally installed into the work surface to allow for extra stacking.



Easily access the washable and/or disposable backwall pre-filter from inside the work zone.

# NU-677 Specifications

Class, Type, Style	Class II, Type A2, Benchtop		
Model #	NU-677-400	NU-677-500	NU-677-600
Nominal Widths	4 ft [1.2 m]	5 ft [1.5 m]	6 ft [1.8 m]
Work Zone Dimensions (W x D x H)	46.4 x 25.5 x 28.5 in [1178 x 648 x 724 mm]	58.4 x 25.5 x 28.5 in [1483 x 648 x 724 mm]	70.4 x 25.5 x 28.5 in [1788 x 648 x 724 mm]
Exterior Dimensions (W x D x H)	53.5 x 32.2 x (79-97.5) in [1359 x 816 x (2007-2477) mm]	65.5 x 32.2 x (79-97.5) in [1664 x 816 x (2007-2477) mm]	77.5 x 32.2 x (79-97.5) in [1969 x 816 x (2007-2477) mm]
Net Weight	750 lbs [340 kg]	815 lbs [369 kg]	880 lbs [398 kg]
Certifications	NSF, UL listed, CE, UKCA		
Access Opening / Type	12 in [305 mm] / Sloped		
Electrical	115 VAC / 60 Hz   230 VAC / 50-60 Hz		
Filter Load Capacity	250%		
Airflow	105 fpm [0.53 m/s] Dynamic Inflow, 60 fpm [0.30 m/s] True Laminar Down Flow ISO Class 5 Air Protection		
Supply Filter	3 in [76 mm] HEPA 99.99% Efficient @ 0.3 microns 3 in [76 mm] HEPA H14 99.995% Efficient @ MPPS		
Pre-Filter	Animal Hair / Dander Pre-Filter		
Exhaust Filter	11.5 in [292 mm] HEPA 99.99% Efficient @ 0.3 microns 11.5 in [292 mm] HEPA H14 99.995% Efficient @ MPPS		
Control System	Aeromax™ w/ PressureFlow™ Pressure Sensor		
Lighting	LED Ultraviolet (UV) Light		
Password Protection	Yes		
Noise Level	Up to 62 dba		
Construction	Coved Interior Corners		
	Side-Mounted Push/Pull Bars		
	Two (2) Back-Wall Electrical Outlets		
	Removable Stainless Steel Easy-to-Clean Prop-Up Flat Work Tray		
	Attachable Stainless Steel Armrest		
	16/18 gauge Stainless Steel Welded Construction		
	Stainless Steel Spill Trough w/ Drain Valve		
	AttenuMont™ Vibration Control Support System		
	Permanent Positive Pressure Plenum w/ Quick Release Supply Filter Removal		
	Frameless Easy-to-Slide Viewing Window		
	Stainless Steel Window Edge Protector		
	Power Cord w/ Twist Lock		
	Up to Four (4) Service Valves/Couplings (Right/Left Sidewalls)		
	Window Sash Magnifying Glass		
	Heated Work Surface (Custom)		
Built-In Waste Disposal System (Custom)			
Integral Base Stand	Motorized Adjustable Base Stand w/ Heavy-Duty Casters		
Popular Accessories	Exhaust Canopy		
	Butterfly Dampeners		
	Adjustable Ergonomic Footrest		

Standard Feature

Optional Feature



*\*Contact your local NuAire distributor for international warranty details.*

# LABGARD NU-610

Class II Type A2 Wall Pass-Through



The LabGard® ES (Energy Saver) NU-610 Class II, Type A2 Dual Access Laminar Airflow Biosafety Cabinet is built directly into the wall of your laboratory, which makes it easy to transfer new animals into a facility or move them between different rooms. NuAire builds each NU-610 model to fit your lab's specific needs. The NU-610 uses a Minihelic™ pressure gauge to constantly monitor and display airflow

pressure within the HEPEX plenum.

All sizing, features, and options can be fully customized to fit your lab's specific needs. The NU-610 meets the standards of a Class II Type A2 BSC, but this model is fully capable of exhausting directly through your lab's HVAC network.

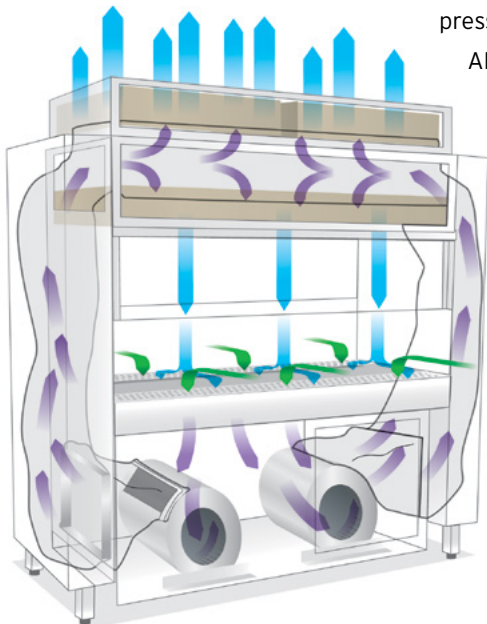

- ➔ HEPA Filtered Air
- ➔ Contaminated Work Zone Air
- ➔ Contaminated Room Air

## NU-610 Specifications

Model #	NU-610 Dual-Access
Certifications	UL listed
Access Opening	12 in [305 mm]
Electrical Requirements	115 VAC / 60 Hz
Filter Load Capacity	150%
Air Barrier	105 fpm [0.53 m/s] Dynamic Air Barrier 60 fpm [0.30 m/s] True Laminar Down Flow ISO Class 5 Air Protection
Supply Filter Options	HEPA 99.99% efficient @ 0.3 microns
Pre-Filter Options	Animal Hair / Dander Pre-filter Deodorizing Charcoal Pre-filter
Exhaust Filter Options	HEPA 99.99% efficient @ 0.3 microns
Pressure / Airflow Sensor	Minihelic™ Pressure Gauge
Lighting	LED
Noise Level	Up to 67 dba
Construction	Removable Stainless Steel Covered Work Tray Easy-to-Clean Prop-Up Work Tray Monolithic Stainless Steel Welded Pressure Tight Attenuant™ Vibration Control Support System Permanent Positive Pressure Plenum w/ Quick Release Supply Filter Removal Additional Service Valves and/or GFCI Outlets Heated Work Surface (Custom)
	Standard Feature
	Optional Feature

**1** YEAR WARRANTY  
PARTS + LABOR + FILTERS  
United States, Canada

\*Contact your local NuAire distributor for international warranty details.

# CUSTOM SOLUTIONS

## Engineered to Your Lab's Specific Needs

In every NuAire product you'll find brilliant yet practical design with keen attention to detail in every phase of the fabrication and assembly process; you'll always receive thoroughly tested equipment at outstanding value, and with dependable customer service guaranteed. These are the fundamentals for NuAire's international reputation and the reasoning behind our universal recognition as the world's finest. Despite our engineers' finely honed genius, your lab may require something that has never been done before. Luckily, our custom sales department has decades of experience in crafting all sorts of new and innovative laboratory equipment to meet your specific

needs. We routinely reshape a cabinet's inner and outer dimensions to neatly house any oversized automation or robotic equipment. We can add computer arms, monitor windows, and/or microscope windows into our standard models, as well. Another common customization involves installing an IV bar with smooth interiors for efficient and ergonomic pharmacy compounding. Regardless of what type of modification your lab and research may require, NuAire is capable of meeting any unique laboratory need and provide excellent troubleshooting support for years to come, ensuring your custom equipment continues to perform at peak levels for its entire lifespan.

**If your lab requires a unique solution, give us a call; we love a challenge.**



This Class I BSC was created at a nominal width of 8' [2.4 m], with clear polypropylene sidewalls, and a custom mounted IV bar.



This LabGuard BSC was fitted with a microscope viewing window to accommodate workflow specializing in human cell tissue research.



A custom model NU-240 was designed to offer a broader and taller work zone to accommodate a single workflow process involving microscopes. A customized isolation table was added to eliminate vibration in the work surface. The extended work surface allows a technician to perform several protocols without having to leave the work zone.

# OPTIONS & ACCESSORIES

Add and Extend Your Lab's Capabilities

Personalize Your NuAire Laboratory Equipment for Extra Comfort and Versatility. Any NuAire biosafety cabinet can be customized for any scientific application while preserving user comfort and safety for the entire day.

## Construction & Accessory Options

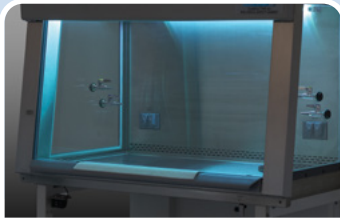

Ultraviolet (UV) Light



Independent Airflow Alarm



Forearm Armrest Pad



Service Valves/Couplings



Electrical Outlets



Stainless Steel Turntable



Animal Feed Hopper(s)

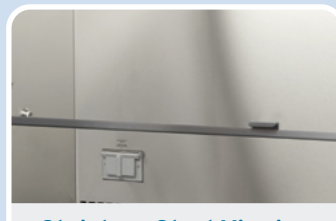

Stainless Steel Viewing Window Edge Protector



Side-Mounted Shelf

## Exhausting & Transitions

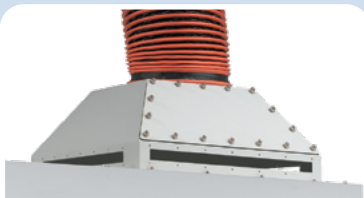

Fixed Exhaust Canopy Transition



Manual / Automatic Butterfly Valves

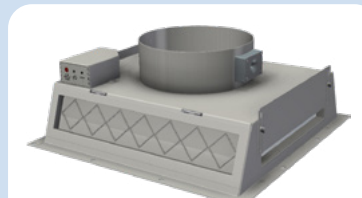

Variable Flow Canopy (VFC) Exhaust Transition w/ Alarm

# COMPLETE YOUR LABORATORY

Add and Extend Your Lab's Capabilities

NuAire manufactures scientific laboratory equipment and compounding pharmacy airflow products, which provide personnel, product, and environmental protection in critical research facilities throughout the world. Continue your journey with the NuAire family by completing your laboratory with the full suite of NuAire quality products.



**LABGARD**  
Biosafety Cabinets



**LABGARD**  
Containment Ventilated Enclosures



**IN-VITROCELL**  
CO<sub>2</sub> Incubators



**AIRECARD**  
Laminar Airflow Workstations



**ALLERGARD**  
Animal Handling Stations



**BLIZZARD**  
Ultralow Freezers



**PHARMAGARD**  
Restricted Access Barrier Systems



Custom Solutions

# VIVARIUM EQUIPMENT



**The Safer Choice**

For more information please visit:

[www.nuaire.com](http://www.nuaire.com) or call **1.800.328.3352**



Your Local NuAire Partner:



ISO 13485:2016 Fernbrook  
ISO 9001:2015 & Niagara  
CERTIFIED Locations



Learn More or Request  
a Free Quote Online