

LABGUARD®



BIO SAFETY CABINETS

The Safer Choice





TABLE OF CONTENTS

The NuAire Advantage.....	1
Biosafety Cabinet Basics.....	2
Fundamentals of the NuAire Design.....	4
Biosafety Cabinet Classes & Types.....	8
Class I Biosafety Cabinets.....	11
Class II Type A2 Biosafety Cabinets.....	14
Class II Type B1 Biosafety Cabinets.....	24
Class II Type B2 Biosafety Cabinets.....	25
Custom Solutions.....	28
Industry Applications.....	29
Popular BSC Accessories.....	30
Complete Your Laboratory.....	32



ISO 13485:2016 Fernbrook
ISO 9001:2015 & Niagara
CERTIFIED Locations



NUAIRE

THE NUAIRE ADVANTAGE

In 1971, Max D. Peters designed his first Biosafety Cabinet (BSC) from inside his garage at the behest of the National Institute of Health (NIH) in Bethesda, Maryland. The NIH put out a public purchase order (NIH-O3-112c) for a machine that could guarantee the safety of scientific personnel and their research specimens. Max D. Peters helped establish the very fundamental standards that all modern Biosafety Cabinets are held to this very day. After being awarded the NIH contract, a new laboratory equipment engineering and manufacturing company, NuAire, was born. Today, NuAire, Inc. is still owned and operated by the Peters family in Plymouth, MN.

For over half a century, NuAire has consistently led the industry in safety standards and customer satisfaction. We obsess over our customers' needs and tailor unique solutions to meet those needs. With invaluable input from customers like you, we now offer a wide range of biological safety cabinets, CO₂ incubators, animal handling devices, centrifuges, ultralow freezers, acid-resistant polypropylene cabinetry and fume hoods, hospital pharmacy compounding isolators, and much more. With our cutting-edge robotic sheet metal facility, we are able to deliver you custom, innovative laboratory safety solutions in addition to the standard products that we sell.

NuAire, Inc. has now sold more than 100,000 Biosafety Cabinets in more than 150 countries, spanning across all seven of the world's continents. We pride ourselves on our products' industry leading quality, reliability, low cost of ownership, and environmental sustainability. Our quality management system is certified to adhere to ISO 9001:2015 and 13485:2016 requirements. Our products are also celebrated for their ergonomic design, ease of use, and quiet operation. All standard BSC units sold in the US and Canada come with a 5 year parts & labor warranty. Every one of our machines are built specifically to your order, so we can guarantee your satisfaction.

As NuAire continues to grow, we are committed to continuously improving our products and expanding our offerings. We always strive to provide you with the optimum level of personnel, environmental, and product protection throughout any industry.

NuAire's Quality Policy:

- Satisfy Customers
- Comply with System Requirements
- Continually Improve

Choose NuAire as the safer choice for your laboratory.



WHAT IS A BIOSAFETY CABINET?

A Biosafety Cabinet (BSC) is an enclosed laboratory workspace for safely handling potentially contaminated or other hazardous materials requiring a predefined level of biosafety. By combining unidirectional airflow from the top of the workspace with air inflow from the room, a biosafety cabinet maintains a dynamic air barrier that protects scientific personnel and their products from outside contamination. Several different classes of biosafety cabinets exist, defined by the varying degrees of bio-containment required. Several types exist within those classes, dictated by how much of the air passing through the work zone is exhausted or recirculated. All cabinets utilize High Efficiency Particulate Air (HEPA) or Ultra Low Particulate Air (ULPA) filters to maintain an aseptic environment within the workspace.

A BSC must supply the necessary level of safety at an affordable cost of ownership. Meeting those criteria as effectively as possible depends on the cabinet's design and components. NuAire's unique HEPEX™ Zero Leak Airflow system evenly disperses downflow air across the supply filter, minimizes vibration transfer, and eliminates potential leaks by surrounding the positive pressure plenum with negatively pressurized chambers. Reinforced by NIH guidelines, NuAire's ultra-high efficiency DC ECM motor offers improved reliability and safety by utilizing a single control point to regulate both air down-flow and inflow when compared to a dual-motor system. The DC ECM motor also automatically adjusts its speed to maintain consistent airflow settings based on readings from the on-board Electronic Control System (ECS).

Classes & Types of Biosafety Cabinets

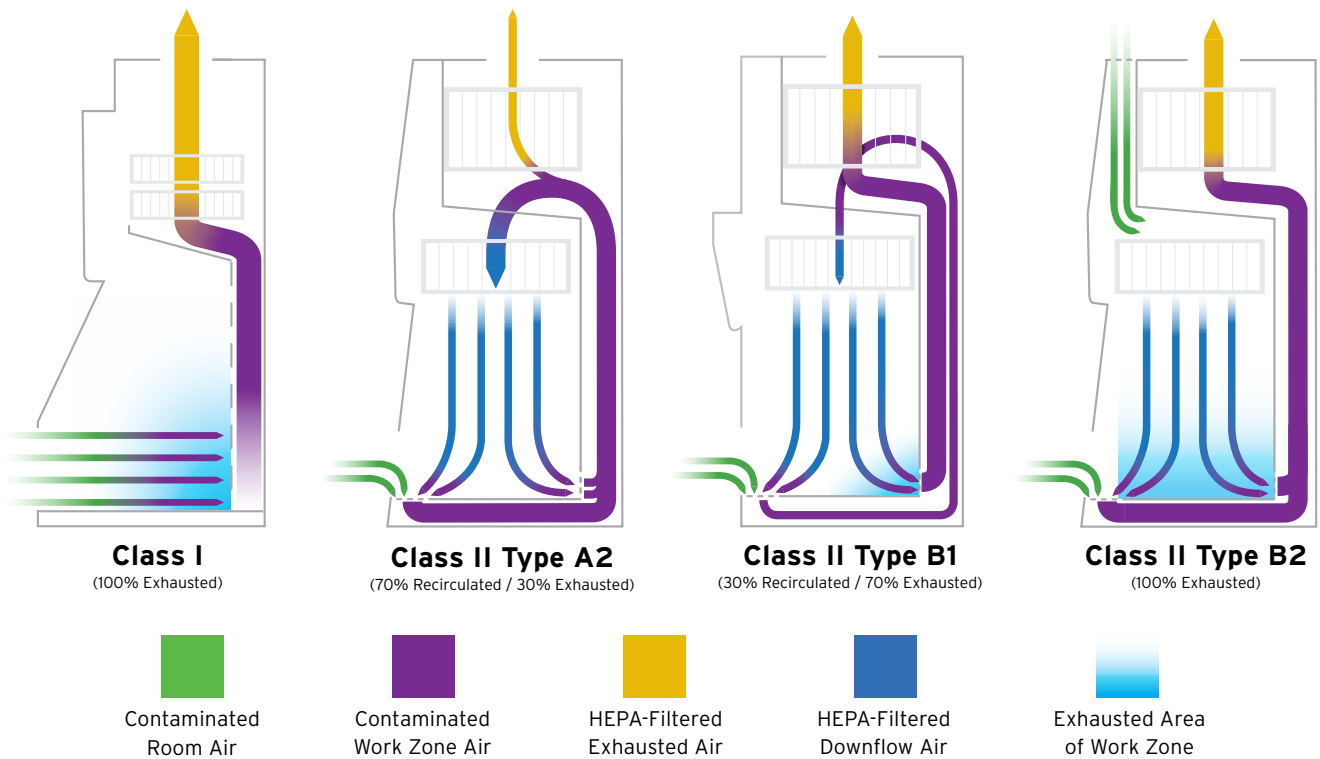

Class I biosafety cabinets rely solely on a minimum of 75 fpm [0.38 m/s] inward airflow velocity for personnel protection. Class II BSCs provide product, personnel, and environmental protection by combining unidirectional downward airflow with a dynamic air barrier. Within class II, there are several different types based on which portions of the work zone are recirculated and/or exhausted, as depicted above. Class III, usually installed in maximum containment laboratories, are specifically designed to work with Biosafety Level 4 (BSL-4) pathogens and maintains a physical barrier between personnel and their products. Roughly 90% of all biological safety cabinets installed globally are Class II, Type A2.

YOUR SAFETY IS OUR NUMBER ONE PRIORITY



Our Commitment to Safety does not just stop at simply meeting the industry standards. Every NuAire product goes through a stringent series of checks and balances before it arrives at your laboratory. As your product moves through each phase in the assembly process, each work station double checks the quality of the previous station; all filters are triple checked.

Automatic Airflow Compensation: NuAire's Ultra-High Efficiency DC ECM Motor will automatically adjust speed to maintain consistent airflow settings based on readings from its on-board Electronic Control System (ECS). The ECS also displays current airflow/pressure in real time with the ability to export all recorded data via USB port located behind the drop-down service panel above the work zone.



true laminar

True laminar (unidirectional) downward moving air, utilized in class II BSCs, flushes the work surface at 60-70 fpm (0.30-0.36 m/s) minimizing cross-contamination within the work zone.

dynamic air barrier

Class II BSCs create a dynamic air barrier at the front of the cabinet, which separates the laboratory from the work zone at a constant inflow speed of 105 fpm (0.53 m/s).

QUALITY - NOTHING IS BUILT LIKE A NUAIRE MODEL

The Core of a NuAire Biosafety Cabinet is a Pressure-tight Monolithic Shell [A] of 100% stainless steel; it is constructed to meet the design, performance, and cleanability standards of NSF/ANSI 49 and EN12469. This monolithic design eliminates any leaks and structural weakness commonly found in cabinets utilizing a multi-piece shell and relying on rivets, gaskets, and/or silicone coating to secure joints.

The NuAire design is a single sheet of type 304 stainless steel. A stainless steel wrap [B] makes up the walls of the cabinet. Stainless steel sheets [C] are seam welded in place to make up the top and bottom of the cabinet. A smaller wrap [D] featuring covered interior corners is seam welded in place to make up the back and side walls of the cabinet. This improves the cabinet's structural integrity by creating a double sidewall. Work tray supports [E] help minimize any vibration transfer from the shell of the cabinet to the work zone. The work tray and front grill supports are removable for full, uninterrupted access to the cabinet base area for easy cleaning.

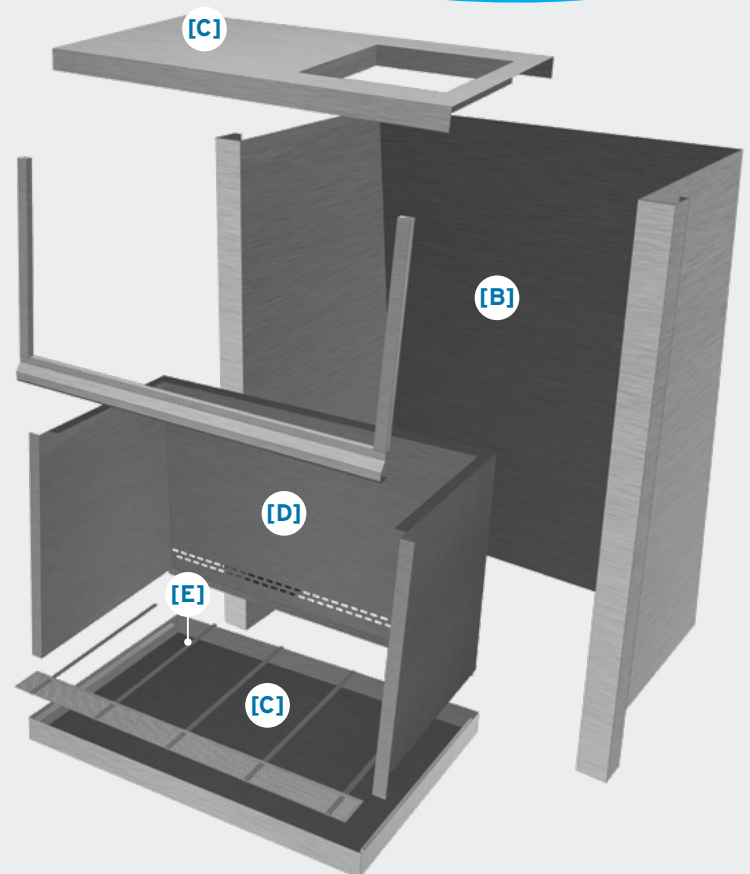
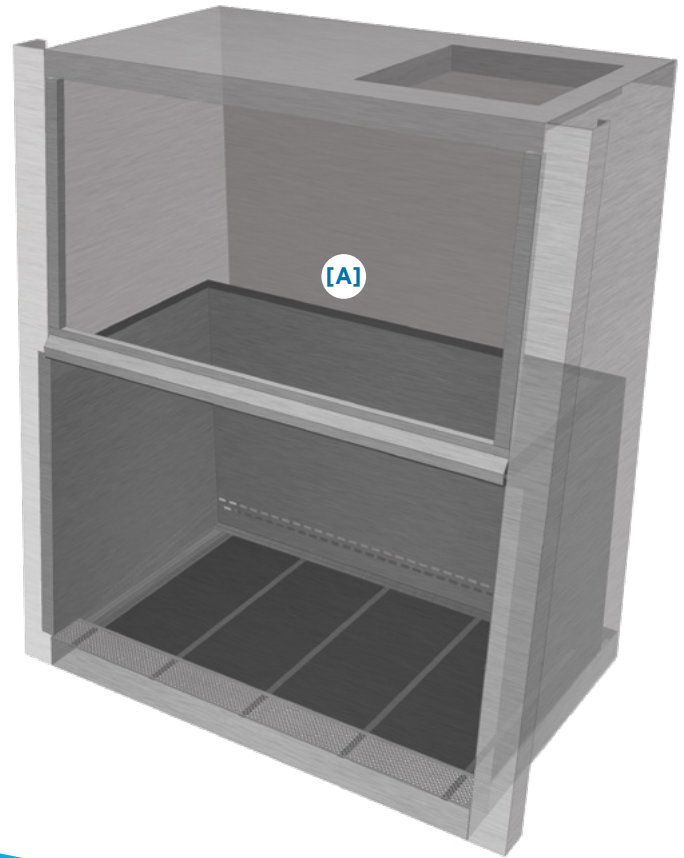

SAVE MORE MONEY OVER A LONGER PERIOD OF TIME.

Sustainability

NuAire remains committed to improving our local and global economies, environment, and social communities by utilizing products and supplies that minimize energy consumption and our environmental impact. We use recycled materials that will not deplete any natural resources whenever possible. We also offer a multitude of support and replacement plans to ensure you maximize the lifespan of your NuAire lab equipment.

Ultra-High Efficiency DC ECM Motor.

Combining a single ultra-high efficiency DC ECM motor with forward facing fan blades reduces energy consumption while extending the lifespan of your filters. Our LabGard® Series offer the lowest total cost of ownership when compared to other BSC models.*

* Compares NuAire DC ECM motor technology and a BSC featuring DC motor technology.

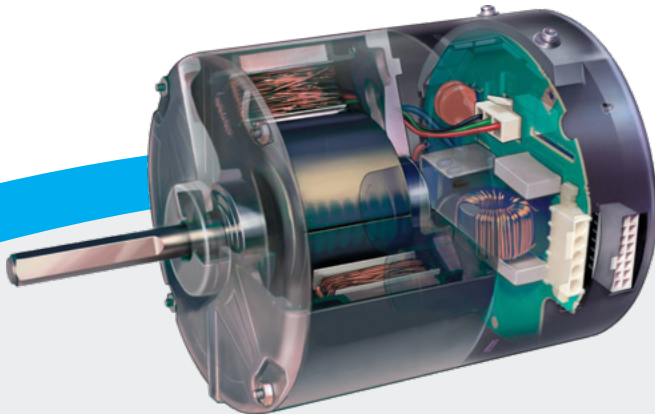
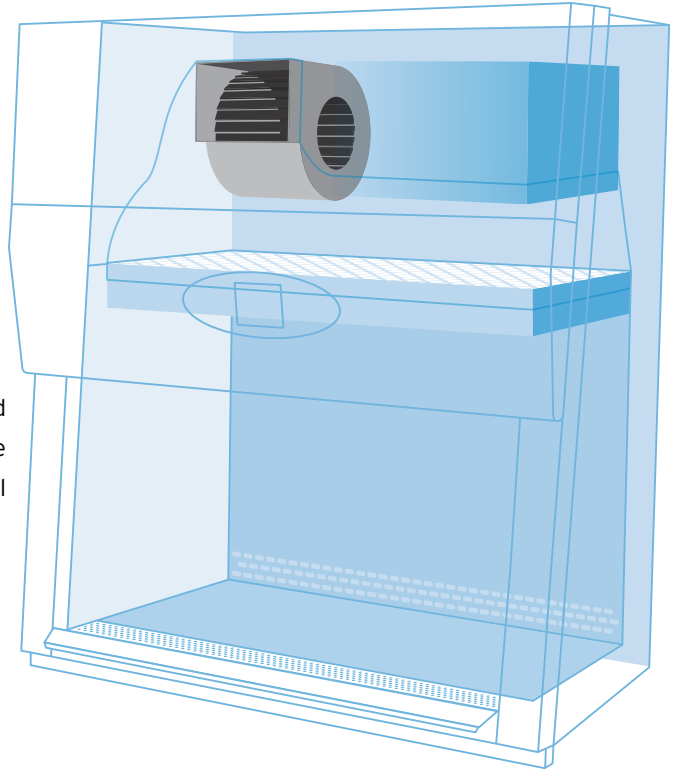

Total Cost of Ownership Breakdown.

Motor Comparison	NuAire DC ECM	NuAire AC PSC	BSC with AC 3-Phase	BSC with DC
8 hrs per day / 5 days per week = 2,000 hrs per year				
KWH per year	598	1128	828	326
\$0.09/kwh	\$54	\$102	\$75	\$29
24 hrs per day / 7 days per week = 8,736 hrs per year				
KWH per year	2612	4927	3617	1424
\$0.09/kwh	\$235	\$443	\$326	\$128
15 Year Life Cycle Costs				
Avg. Filter Changes*	1 Set	2 Sets	1 Set	3 Sets
Estimated Cost of HEPA Filters	\$715	\$1,430	\$715	\$2,145
Total Cost of Decon/Certification	\$450	\$900	\$450	\$1,350
Motors to Replace**	1 Motor	1 Motor	1 Motor	2 Motors
Cost of Motors/ Power Supplies/ Fan Control	\$650	\$420	\$725	\$2,544
Utility Costs (2,000 hrs/yr over 15 years)	\$810	\$1,530	\$1,125	\$435
Total Cost of Ownership	\$2,625	\$4,280	\$3,015	\$6,474

* estimate based on filter load capacity

** estimate based on historical information.

Disclaimer: This example is for illustrative purposes only and should not be deemed a representation of future performance or a guarantee of any kind. Information is based on internal performance data obtained through NuAire testing and information provided by motor, blower, HEPA filter manufacturers, and independent service technicians.

ERGONOMIC DESIGN

NuAire Laboratory Equipment Boasts Superior Ergonomics Without Compromising on Safety. Scientists often spend eight or more hours sitting in front of a biosafety cabinet; this makes all day comfort a necessity. Our engineers' designs specifically reduce arm, shoulder, and neck strain that often contribute to workplace injuries.

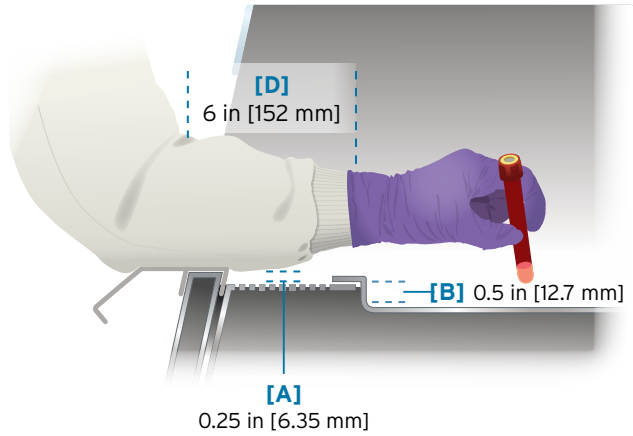

All NuAire equipment complies with the Americans with Disabilities Act (ADA). A recessed airfoil grill [A] allows users to rest their arms without obstructing airflow. A recessed work tray [B] also provides users additional flexibility when working with bottles or pipettes. The centrally located control panel [C] combined with a shorter reach into the work zone [D] allows users to bring work closer without sacrificing safety. An ergonomically designed chair [E] with the optionally available footrest [F] provide optimal back and leg support.

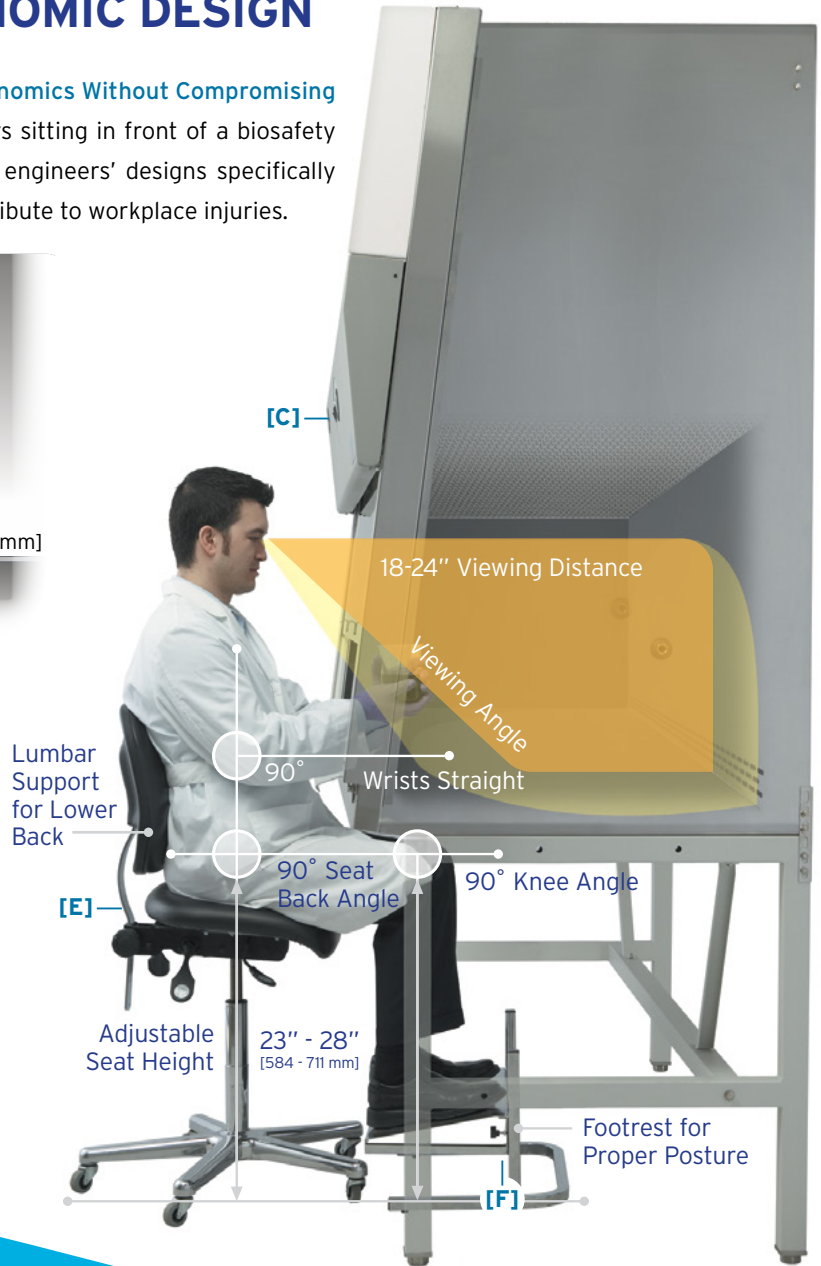

Options & Features

- Increased Knee & Leg Room
- Augmented Cabinet Work Zone
- Adjustable IV Bar w/ Six (6) SST Hooks
- Adjustable Base Stand and Footrest Options
- Movable Elbow Rests w/ Silicone Padding
- Outlets & Staggered Service Valves
- Stainless Steel Turntable Accessories



MAKE IT EASIER ON YOUR SERVICE PERSONNEL

100% of All Service Functions Can be Performed From the Front or Top of the Cabinet. No repositioning necessary! Our NuAire engineers have designed each LabGard® Biosafety Cabinet maintenance to be cheap and easy for service professionals, which reduces machine downtime. Most NuAire biosafety cabinets can also be fitted with our unique Bag-In-Bag-Out option, ensuring that all exhaust filters can be removed quickly and safely.

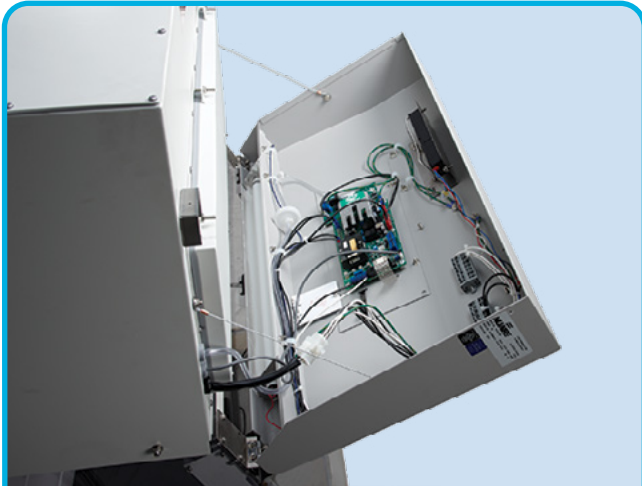

Drop Down Control Panel

Electronic, lighting, and filter components are easily accessible through the hinged front panel.

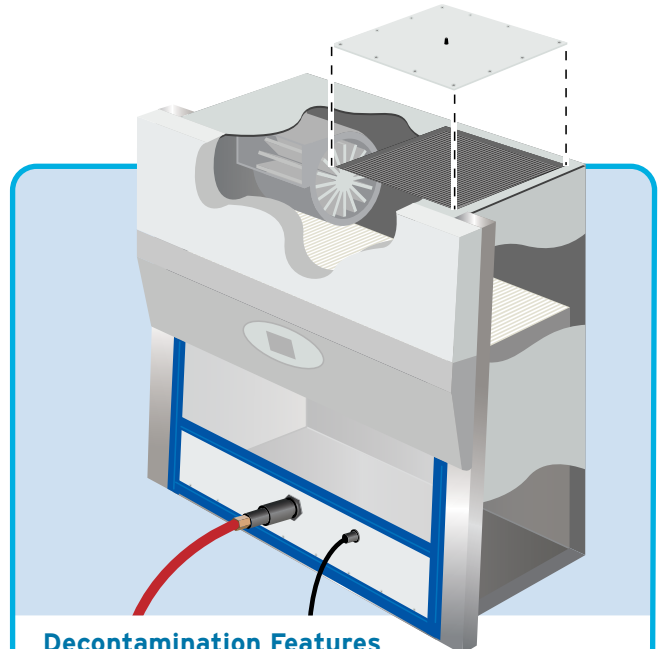

Decontamination Features

Easily connect to a variety of decontamination systems that use formaldehyde, chlorine dioxide, or vapor phase hydrogen peroxide with our **DECON101** system.



Access filters and the blower motor from the front of the cabinet with the easy removal of safety panel.



Easy access to exhaust choke **[F]** for airflow certification.

WHAT CLASS DO YOU NEED?

The U.S. Centers for Disease Control and Prevention (CDC) Classifies All Biosafety Cabinets into Three (3) Classes. Class I biosafety cabinets rely on a minimum inward airflow velocity of 75 fpm [0.38 m/s] to provide personnel and environmental protection. Class II BSCs provide product, personnel, and environmental protection by combining unidirectional downward airflow with inward airflow taken from the room to create a dynamic air barrier. Within Class II, several different types exist, distinguished by inward airflow velocity and how much air from the work zone is exhausted or recirculated. Class III, usually installed in maximum containment laboratories, is specifically designed for Biosafety Level 4 (BSL-4) pathogen protection and maintains a physical barrier between lab personnel and their products.

What Class and Type You Need Will Ultimately Depend on the Type of Work You Plan on Conducting Inside Your BSC. Roughly 90% of all biological safety cabinets installed globally are Class II Type A2, however, there are several fundamental design differences within the A2 types depending on their intended industries. The amount of features and options can seem daunting to most, but many of NuAire's cabinet models are outlined below based on common industry standards. We also employ some of the most well-trained sales and customer service representatives in the industry that can assist you in proper product selection based off your laboratory's biosafety level, certified chemical risk assessment, and/or specific field of work.*

**NuAire and its employees cannot perform risk assessments*

CLASS II TYPE A2 (70% Recirculated / 30% Exhausted)



environmental,
product & personnel
protection

Research/Pharmacy Compounding/Pharmaceutical



NU-540

NU-543

NU-545

Class II Type A2 Biosafety Cabinets Offer the Greatest Degree of Versatility Among All Types When Working within Biosafety Levels 1-3. Type A2s recirculate 70% of the air passing through the work zone. The HEPA filtered air can be optionally exhausted through your facility's HVAC system or back into your laboratory. All BSCs must be fully exhausted when working with volatile or flammable chemicals to avoid any potential safety hazards.

All NuAire Class II Type A2 biosafety cabinets maintain a constant laminar down-flow air velocity of at least 60 fpm [0.30 m/s] and an inflow speed of 100 fpm [0.53 m/s] at the front of the cabinet in order to maintain the dynamic air barrier.

Animal Handling Station



NU-677



NU-640

Cytotoxins



NU-581

Laboratory Automation & Pass-through



NU-125



NU-610

CLASS I (Containment Ventilated Enclosure)



NU-608

NU-813

Class I Biological Safety Cabinets are Generally Designed for Handling and Disposing Low to Moderate Risk Agents while Providing Personnel, but No Product, Protection by pulling ambient air past the operator and through the work zone. This creates an air barrier that prevents work zone contaminants from migrating into your lab. The contaminated air exits through the cabinet's HEPA filtered exhaust system and then recirculates back into the room or continues to be exhausted outside through your facility's HVAC system.

All NuAire Class I biological safety cabinets maintain a minimum inflow velocity of 80 fpm [0.40 m/s] to maintain a strong air barrier between you and your product samples.

CLASS II TYPE B1 (30% Recirculated / 70% Exhausted)



Class II, Type B1 Biological Safety Cabinets Exhaust 70% of Airflow and Must be Connected to a Dedicated HVAC System. The B1 Biosafety Cabinet may be used for work treated with minute quantities of volatile/toxic chemicals and trace amounts of radionuclides required as an adjunct to microbiological studies if allowed by your chemical risk assessment. However, this type of work should be conducted in the directly exhausted portion of the work zone. By recirculating 30% of the air passing through the work zone, the Class II, Type B1 BSC allows greater compatibility with older exhaust systems when compared to its 100% exhausted Type B2 counterparts. Understanding the limitations of your lab's HVAC system is critical to safely operate any exhausted biosafety cabinet.



NU-427

CLASS II TYPE B2 (0% Recirculated / 100% Exhausted)



NU-560

NU-565

Class II Type B2, Often Referred to as Total Exhaust, Biosafety Cabinets Recirculate 0% of the Air Passing Through the Work Zone and must be connected to a dedicated ventilation system. The Type B2 BSC can be optimized to work with volatile/toxic chemicals and radionuclides if allowed by your chemical risk assessment. All NuAire Class II Type B2 models come standard with our TouchLink™ central control center. Scientific professionals working with biosafety level 3 products and in pharmaceutical research often prefer our B2s for their superior level of airflow monitoring and control.

CONTROL PANELS

AEROMAX

The **AeroMax™ Control System** is a simplified control system that monitors and displays airflow status via our single PressureFlow™ sensor - a specialized digital pressure transducer. The control panel also notifies lab workers with both visual and audio alarms if the unit's airflow pressure departs significantly from its set point. The user interface is operated through a series of buttons and LED indicators, which control the unit's single DC ECM motor/blower, UV light, and outlets.

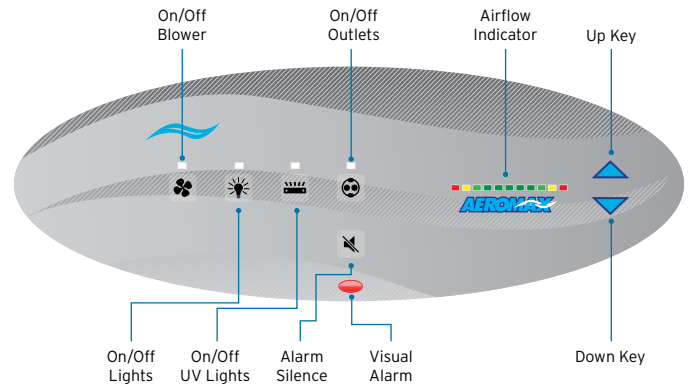

FLOWGARD

The **FlowGard™ Control System** integrates one dual thermistor airflow sensor (IntelliFlow™) to constantly monitor the biosafety cabinet's airflow performance. The FlowGard™ control system also integrates an ultra-high efficiency motor/blower that provides automatic compensation for both filter loading and variances in the line voltage. The user interface is operated through a series of buttons and a small on board screen, which controls the motor blowers, work zone lighting, optional UV lights, unit outlet(s), audio/visual alarms.

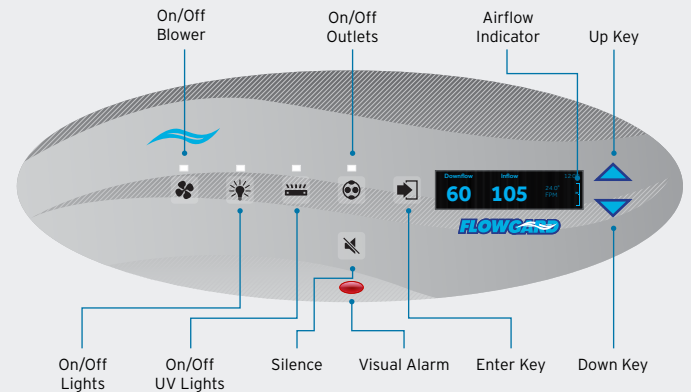

TOUCLINK

The **TouchLink™ LCD Electronic Control System (ECS)** utilizes two dual digital thermistor airflow sensors to monitor and display airflow in real-time in Class II Type A2 cabinets. A single thermistor airflow sensor in the work zone with a digital differential velocity pressure flow grid in the exhaust air stream monitors for exhaust volume and subsequent inflow velocity in Type B1 & B2 cabinets. The control system automatically compensates for variances in filter loading and voltage and other environmental effects. The TouchLink™ ECS also simplifies biosafety cabinet maintenance by recording detailed diagnostics. Step-by-step decontamination procedures can also be controlled via the on-board control center. The TouchLink™ ECS can even warm up the blower motor before you arrive and set all lights on a customizable schedule for optimal efficiency.

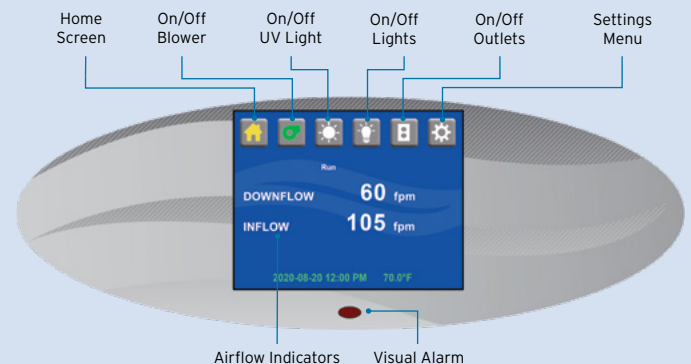



The LabGard[®] ES (Energy Saver) NU-813 is a Class I Bio-safety Cabinet (BSC), which also serves as a Containment Ventilated Enclosure (CVE), which offers personnel protection for the safe handling of hazardous, non-sterile powders and low-risk aerosols or particulate matter. The NU-813 creates an air barrier at the front access opening by pulling ambient air past the operator and through the work zone. The Class I cabinet is ideal for non-sterile drug compounding and disposal within a Containment Segregated Compounding Area (C-SCA) and/or animal necropsy research.

Equipped with a single or (optional) redundant HEPA filtration system, the air flows through the cabinet then exits through the filter(s), which removes any contaminants that could put personnel at risk. This cabinet is equipped with the AeroMax™ electronic control system for easy operation. The NU-813 also comes standard with our ultra-high-efficiency ECM motor, which can help reduce energy consumption and lower your lab's overhead expenses.

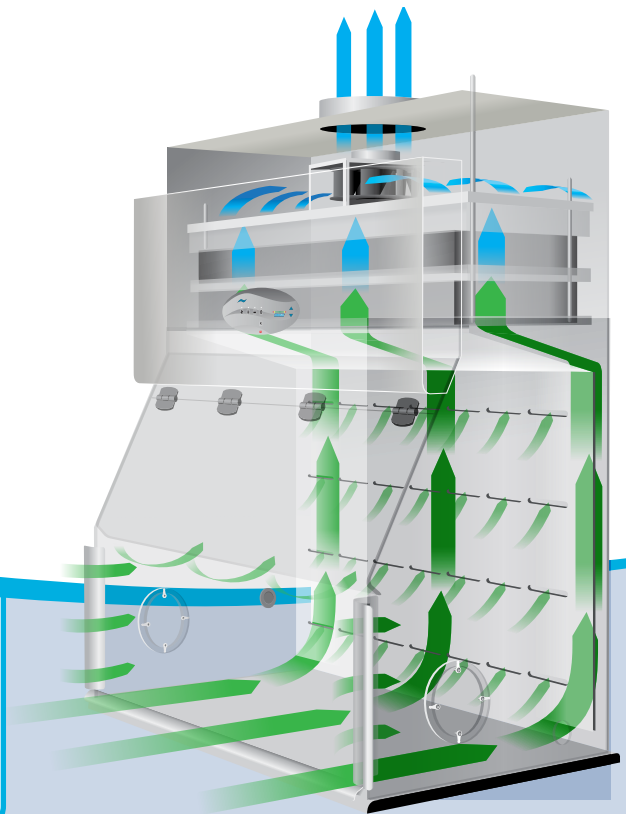

➡ HEPA Filtered Air
 ➡ Contaminated Room Air

The Bag-In-Bag-Out HEPA filter feature is a simplified way to remove your BSC's exhaust HEPA filter(s), limiting the risk of exposing technicians or lab personnel to potentially harmful contaminants.

CLASS I

(Containment Ventilated Enclosure)

The AllerGard® ES NU-608 Class I Animal Bedding Disposal and Containment Cabinet minimizes the risk of exposure to allergens and animal infections when handling low to moderate risk materials. Cleaning out cages and handling infested animal bedding may not be the most glamorous task, but the NU-608 makes it convenient, safe, and efficient. This waste disposal cabinet maintains an active air barrier with a constant 105 FPM [0.53 m/s] inflow air velocity to ensure that all particulates remain inside the disposal station at all times. The stainless steel work surface and side panels are also very easy to clean and sanitize. A stainless steel bang-bar over the trash chute and deodorizing charcoal exhaust filter also come standard with every unit.

ALLERGARD^{ES}

NU-608 CLASS I ANIMAL BEDDING DISPOSAL CABINET

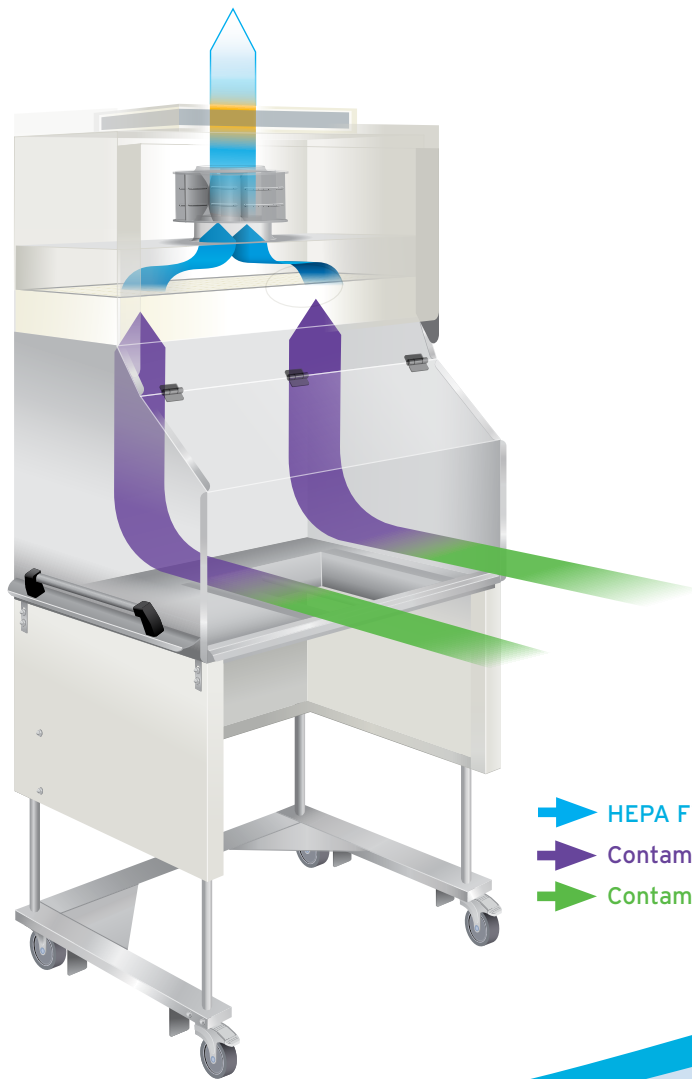

- ▶ HEPA Filtered Air
- ▶ Contaminated Work Zone Air
- ▶ Contaminated Room Air

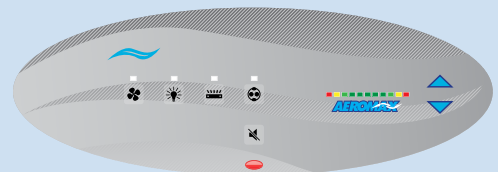

AeroMax™ Electronic Control System

Class I		
Industry	Pharmacy / Compounding	Vivarium
Model #	NU-813	NU-608
Cabinet Style	Bench Top w/ Optional Base Stand	Animal Waste Station (Console)
Nominal Width	3, 4, 6 ft [0.9, 1.2, 1.8 m]	4 ft [1.2 m]
Workspace Dimensions (W x D x H)	(34.3 / 46.3 / 70.3) x 24 x 28 in [(873 / 1178 / 1787) x 610 x 711 mm]	46.25 x 29.75 x 28 in [1174 x 756 x 711 mm]
Exterior Dimensions (W x D x H)	(36 / 48 / 72) x 29 x 54 in [(914 / 1219 / 1829) x 737 x 1372 mm]	52.75 x 33.4 x (84.75 - 96.75) in [1340 x 848 x (2153 - 2457) mm]
Net Weight	300 - 500 lbs [136 - 227 kg]	400 lbs [181 kg]
Certifications	UL listed, ADA Compliant	
Access Opening	8 in [203 mm]	14 in [356 mm]
Electrical Requirements	115 VAC / 60 Hz	
Air Barrier	80 fpm [0.41 m/s] Inflow	105 fpm [0.53 m/s] Inflow
Filter Options	5.875 in [149 mm] Single HEPA 99.995% @ 0.3 micron Efficiency	6 in [152 mm] Single HEPA 99.99% @ 0.3 micron Efficiency
	Double HEPA Exhaust Option	
	Purifil and/or Charcoal Pre-filter Options	
Exhaust Options	Exhaust Collar	C-25 Charcoal Exhaust Filter Module
	Lay-in Charcoal Transition	
	Canopy Exhaust Transition	
	Exhaust Deflector	
Control System	AeroMax™ w/ PressureFlow™ Monitor	
Lighting	Fluorescent	LED
	LED	
Noise Level	Up to 62 dba	Up to 65 dba
Construction Options	Removable Stainless Steel Air Foils	
	Stainless Steel Work Surface Insert Option	Single Rectangular Disposal Chute w/ Stainless Steel Bang-Bar
	White Polycarbonate Back Wall	
	0.5 in [13 mm] Thick Clear Polycarbonate Sidewalls	
	Black Epoxy Work Surface	
	Gasketed Side Ports	
	Service Valves	
	Sidewall Waste Chutes	
Duplex GFCI Outlets (Right or Left Sidewalls)		
Seismic Brackets (Rear / Floor Mount)		
Base Stand Options	Telescoping Base Stand w/ Casters or Leg Levelers	Telescoping Base Stand w/ Casters
	Motorized Base Stand w/ Casters or Leg Levelers	
Popular Accessories	Independent Low Airflow Monitor	
	Stainless Steel Turntable	Not Available
	Stainless Steel Side-Mounted Shelf	
	Ergonomic Adjustable Footrest	

Standard Feature

Optional Feature



**Contact your local NuAire distributor for international warranty details.*



CLASS II TYPE A2

(70% Recirculated / 30% Exhausted)



The LabGard® ES (Energy Saver) Model NU-540 Class II, Type A2 Biosafety Cabinet is a bench/table top model with available base stand options. The NU-540 offers economical operation through the use of a single ultra-high efficiency DC ECM motor to limit energy consumption and maximize filter lifespan. This model offers all the essential functions of a Type A2 BSC at our most affordable price, making this ideal for an academic environment. It can also be easily optimized for pharmacy compounding with the optional IV bar attachment. NuAire's unique monolithic stainless steel construction makes cleaning your workspace quick and easy while also ensuring your cabinet remains strong and robust for its entire lifespan. Traditionally, Type A2 cabinets exhaust HEPA filtered air back into the lab, however, a BSC must be fully exhausted through your facility HVAC system when working with non-flammable/volatile chemicals or trace amounts of radionuclides.

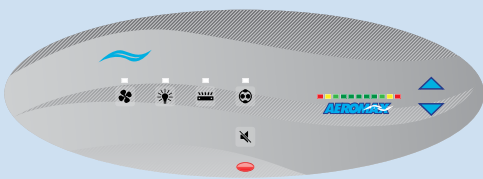
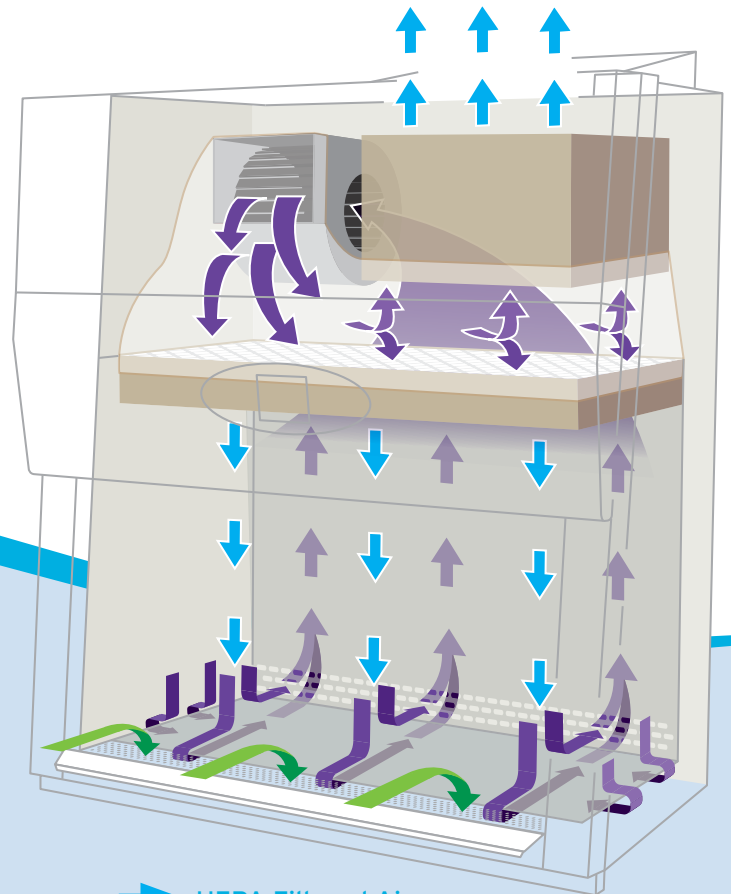

AeroMax™ Electronic Control System



A stainless steel IV bar with three (3) placement options can be added to any NuAire model of BSC. Six (6) IV hooks come standard with any IV bar add-on.

- HEPA Filtered Air
- Contaminated Work Zone Air
- Contaminated Room Air



The LabGuard[®] ES (Energy Saver) AIR Model NU-543 Class II, Type A2 Biosafety Cabinet is a bench/table top model with available base stand options. The NU-543 offers economical operation through the use of our ultra-high efficiency DC ECM motor to limit energy consumption and larger exhaust filters to extend filter load capacity. This LabGuard model also offers the greatest degree of versatility with available accessories and access openings of 8, 10, or 12 inches [203, 254, or 305 mm]. The FlowGard[™] central control system utilizes a single airflow sensor with dual-thermistor IntelliFlow[™] probes to monitor and display the airflow speed in real-time. The NU-543 model is ideal for any laboratory that works with diverse products and within a continually changing environment.



FlowGard[™] Electronic Control System



All GFCI outlets and service valves/couplings can be moved outside the work zone to create a smooth interior for easier cleanability.



The NU-543 optimized for IV and drug compounding workflow featuring a back wall monitor viewing window, IV bar, and additional GFCI outlets.

A fixed exhaust canopy (left) or variable flow canopy transition (right) with a built-in airflow alarm can connect any NuAire Type A2 BSC into your facility's internal exhaust network for added safety and security.

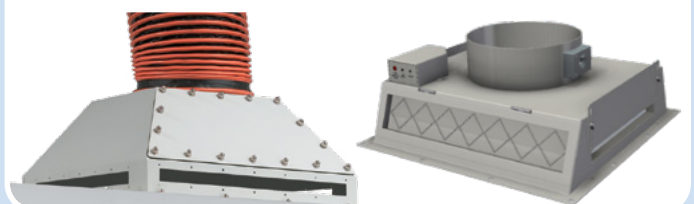

CLASS II TYPE A2

(70% Recirculated / 30% Exhausted)



The LabGard® ES (Energy Saver) AIR Limited Model NU-545 Class II, Type A2 Biosafety Cabinet is a bench/table top model with available base stand options. The Energy Saver DC ECM motor is controlled to airflow set points via the TouchLink™ central control system. The touch-screen control system utilizes two dual digital thermistor airflow sensors that provide automatic compensation for both filter loading and line voltage variances to maintain constant air volume control.



The NU-545 comes standard with interior LED lighting and our Decon101™ technology for easy decontamination. All BSC functions can also be password protected and you can customize the blower schedule, so the cabinet will be ready and warmed up before you even enter the lab.

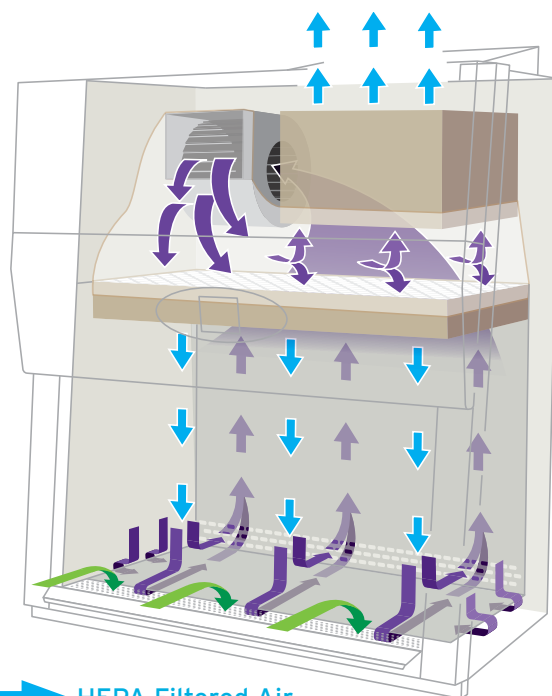

TouchLink™ Electronic Control System

NuAire offers a wide range of exhaust accessories for extra flexibility with any biosafety cabinet. Reduce blower noise and easily connect exhaust transitions to your facility's duct network with our Silicone Connection Sleeve (left). Our Automatic / Manual Butterfly Damper (right) allows additional airflow control to help prevent any risk of environmental contamination while you work. All NuAire exhaust transitions range from 6 to 12 inches [152 to 305 mm] in diameter and quickly connect to any facility's internal HVAC network.



-  HEPA Filtered Air
-  Contaminated Work Zone Air
-  Contaminated Room Air

Class II Type A2			
Model #	NU-540	NU-543	NU-545
Cabinet Style	Bench Top w/ Optional Base Stand		
Nominal Widths	3, 4, 5, 6 ft [0.9, 1.2, 1.5, 1.8 m]		
Workspace Dimensions (W x D x H)	(34.375 / 46.375 / 58.375 / 70.375) x 25.75 x 28.5 in [(873 / 1178 / 1483 / 1788) x 654 x 724 mm]		
Exterior Dimensions (W x D x H)	(42 / 54 / 66 / 78) x 32 x 61 in [(1057 / 1362 / 1669 / 1972) x 799 x 1546 mm]		
Net Weight	400 - 640 lbs [181 - 290 kg]		
Certifications	NSF / ANSI 49, UL listed	NSF / ANSI 49, EN12469, UL listed	
Access Opening	8, 10 in [203, 254 mm]	8, 10, 12 in [203, 254, 305 mm]	8, 10 in [203, 254 mm]
Electrical Requirements	115 VAC / 60 Hz		
Filter Load Capacity	250%		
Air Barrier	105 fpm [0.53 m/s] Dynamic Inflow, 60 fpm [0.30 m/s] True Laminar Down Flow		
	ISO Class 5 Air Protection		
Supply Filter	3 in [76 mm] HEPA 99.99% Efficient @ 0.3 microns		
Exhaust Filter	6 in [152 mm] HEPA 99.99% Efficient @ 0.3 microns	11.5 in [292 mm] HEPA 99.99% Efficient @ 0.3 microns	
Control System	AeroMax™	FlowGard™	TouchLink™
Pressure / Airflow Sensor	PressureFlow™ Pressure Sensor	IntelliFlow™ Airflow Sensor	Dual IntelliFlow™ Airflow Sensors
Lighting	Fluorescent w/ LED Option	LED	
	Ultraviolet (UV) Light Option		
Nitecare™ Compatible	Yes		
Password Protection	Yes		
Decontamination Mode	No	Decon101™	
Customizable Blower Schedule	No		Yes
USB Data Download Port	No		Yes
Noise Level	Up to 63 dba		
Construction Options	Easy-to-Clean Prop-Up Work Tray		
	Two 15 amp Type B Duplex Outlets (Back Wall)	1 GFCI and 1 Type B Duplex Outlets	
	3 Service Couplings and 1 Service Valve (Right/Left Sidewalls Standard or Front Panel Option)		
	Single Cord Pass-Through Port (Right Sidewall; NSF Approved)		
	Removable Stainless Steel Coved Work Tray		
	Coved Interior Corners		
	Frameless Easy-to-Slide Viewing Window		
	Monolithic 16/18 gauge Stainless Steel Welded Pressure Tight Construction		
	Recessed & Removable Front Intake Grill		
	Stainless Steel Spill Trough w/ Drain Valve		
	AttenuMont™ Vibration Control Support System		
	Permanent Positive Pressure Plenum w/ Quick Release Supply Filter Removal		
	Heavy Duty Plastic Armrest w/ Stainless Steel Option	Stainless Steel Front Armrest	
	IV Bar w/ 3 Height Locations, 6 SST Hooks		
	Glass Sidewalls		
	Additional Service Valves, GFCI Duplex Outlets, and/or Pass-Through Ports		
	Seismic Brackets (Rear / Floor Mount)		
	Heated Work Surface (Custom)		
Sinks with Hot/Cold or DI Water Faucets (Custom)			
Base Stand Options	Telescoping Adjustable Base Stand w/ Leg Levelers or Casters		
	Motorized Adjustable Base Stand w/ Leg Levelers or Casters		
Popular Accessories	Adjustable Ergonomic Footrest		
	Silicone Cushioned Movable Elbow Rests		
	Ergotron™ Monitor, Keyboard, and Mouse Mount		
	Storage Pull-Out Trays or Shelves		
Standard Feature		Optional Feature	



*Contact your local NuAire distributor for international warranty details.



CLASS II TYPE A2 (70% Recirculated / 30% Exhausted)



The LabGard® ES (Energy Saver) LP (Low Profile) NU-640 Class II, Type A2 Animal Handling Biosafety Cabinet (BSC) offers the largest access opening with the smallest footprint. The NU-640 is a full console model with a mechanical auto-rising base stand and built-in ergonomic footrest. With an extra large 14 inch [356 mm] hinged access opening and only a 78.25 inch [1988 mm] unit height, this animal handling biological safety cabinet easily handles large rat cages in the smallest of vivarium laboratories. This BSC unit comes standard with heavy-duty reinforced casters and side pull-bars for extra mobility. A flat prop-up work tray allows easy access to the single mesh pre-filter and makes cleaning the work zone a breeze.



AeroMax™ Electronic Control System

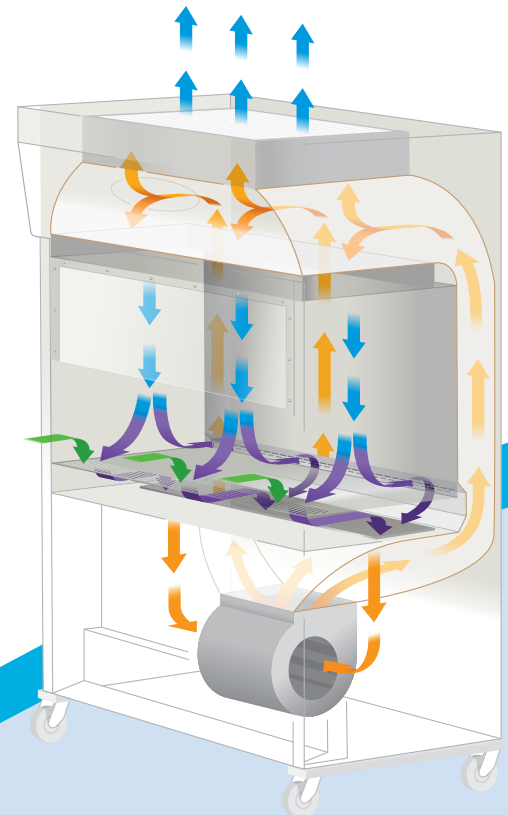

- ➔ HEPA Filtered Air
- ➔ Contaminated Work Zone Air
- ➔ Contaminated Room Air
- ➔ Pre-filtered Work Zone Air

COMPATIBLE WITH LOW CEILINGS

<p>56.375-80.375" [1433-2042 mm] Unit Width (w/ Pull Bars)</p>	<p>33" [838 mm] Unit Depth</p>
<p>78.25-86.25" [1988-2191 mm] Unit Height</p>	
<p>14" [356 mm] Sash Height</p>	
<p>35-43" [889-1092 mm] Work Surface Height</p>	

FITS THROUGH STANDARD DOORWAYS

CLASS II TYPE A2
 (70% Recirculated / 30% Exhausted)



The LabGuard[®] ES (Energy Saver) Model NU-677 Class II Type A2 Biosafety Cabinet/Cage Changing Station is NSF/ANSI listed to provide personnel, product, and environment protection for sensitive animal handling and cage changing procedures. The NU-677 can be exhausted back into the lab or connected to a facility HVAC system. The large 12" [305 mm] access opening accommodates most large mouse and rat cages. The NU-677 comes standard with our mechanical auto-lifting base stand, which allows extra flexibility to help avoid repetitive stress injuries and ensure you stay comfortable throughout your entire work day. The included base stand comes standard with heavy-duty caster wheels to allow for extra mobility within your vivarium.



AeroMax™ Electronic Control System

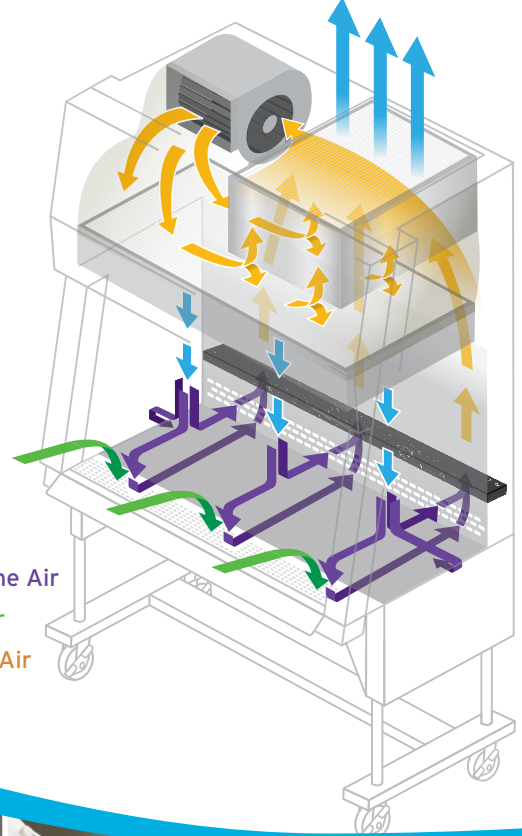

- ➔ HEPA Filtered Air
- ➔ Contaminated Work Zone Air
- ➔ Contaminated Room Air
- ➔ Pre-filtered Work Zone Air



An optional waste bin can be installed into the work surface for safe and convenient disposal.



Deep cage wells can also be optionally installed into the work surface to allow for extra stacking.



Easily access the washable and/or disposable back-wall pre-filter from inside the work zone.

CLASS II TYPE A2

(70% Recirculated / 30% Exhausted)

The LabGuard® ES (Energy Saver) CYTO Model NU-581 Class II, Type A2 Biosafety Cabinet is a full console model featuring a wedge series of HEPA pre-filters mounted under the work surface to remove airborne biological or particulate chemical agents such as cytotoxic API powders from internal airflow before it gets recirculated. The NU-581 comes standard with the telescoping base stand or can be upgraded to the mechanical auto-rising for superior ergonomic comfort. Using a partial Bag-In-Bag-Out feature, the HEPA pre-filters can be replaced easily and safely. NuAire frequently tests this BSC model according to current NSF/ANSI 49 standards. This BSC is also EN12469 and DIN12980 certified. NuAire's Decon101 System makes decontaminating the work zone with liquid formaldehyde and/or ammonia a breeze.



*Optional IV Bar & Mechanical Auto-Rising Base Stand Shown



TouchLink™ Electronic Control System

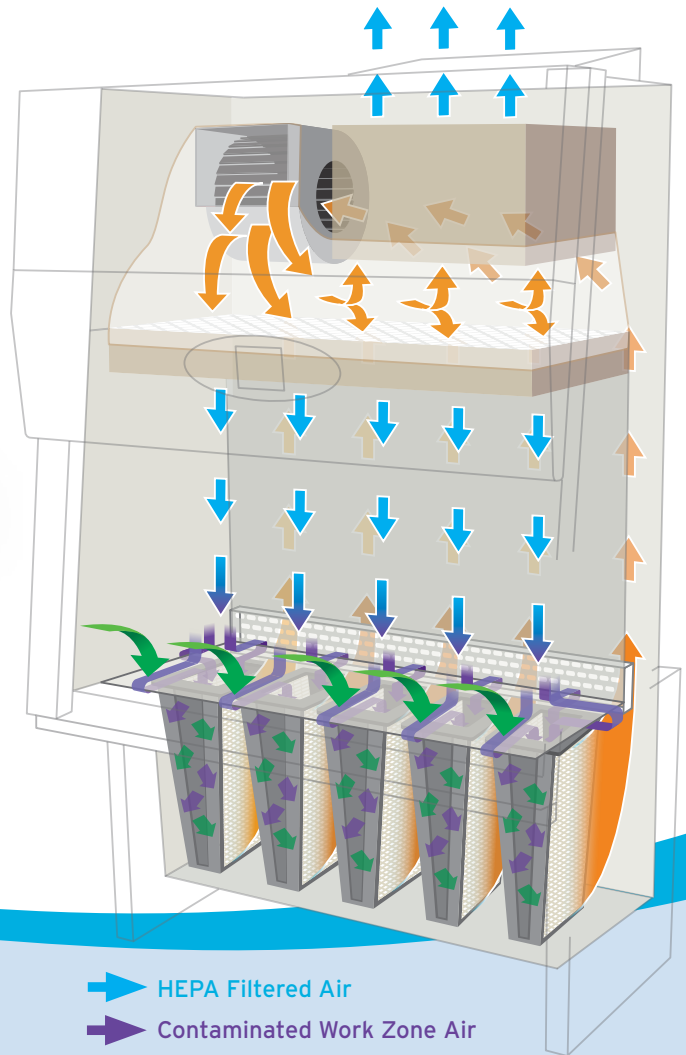

- ➔ HEPA Filtered Air
- ➔ Contaminated Work Zone Air
- ➔ Contaminated Room Air
- ➔ Pre-filtered Work Zone Air

Safely and conveniently remove the wedge series pre-filters just below the work surface using our partial Bag-In-Bag-Out feature.



Class II Type A2			
Industry	Vivarium		Cyto-Toxins
Model #	NU-640	NU-677	NU-581
Cabinet Style	Console	Bench Top w/ Optional Base Stand	Console
Nominal Widths	4, 5, 6 ft [1.2, 1.5, 1.8 m]		
Workspace Dimensions (W x D x H)	(46.5 / 58.5 / 70.5) x 22.75 x 24.6 in [(1181 / 1486 / 1791) x 578 x 626 mm]	(46.3 / 58.3 / 70.3) x 25.5 x 28.5 in [(1178 / 1483 / 1788) x 642 x 724 mm]	(46.3 / 58.3 / 70.3) x 26 x 28.5 in [(1178 / 1483 / 1788) x 660 x 724 mm]
Exterior Dimensions (W x D x H)	(56.4 / 68.4 / 80.4) x 33 x 78.3 in [(1433 / 1737 / 2042) x 838 x 1987 mm]	(53.6 / 65.6 / 77.6) x 32.1 x 79 in [(1358 / 1663 / 1968) x 832 x 2007 mm]	(55 / 67 / 79) x 33 x 86.9 in [(1394 / 1699 / 2003) x 838 x 2207 mm]
Net Weight	560 - 740 lbs [254 - 336 kg]	750 - 880 lbs [340 - 398 kg]	700 - 880 lbs [318 - 400 kg]
Certifications	UL Listed*	NSF / ANSI 49, UL listed	UL listed*
Access Opening	14 in [356 mm]	12 in [305 mm]	8, 10 in [203, 254 mm] Manual Slide
			8 in [203 mm] Auto Slide Access
Electrical Requirements	115 VAC / 60 Hz		
Filter Load Capacity	250%		150%
Air Barrier	105 fpm [0.53 m/s] Dynamic Inflow, 60 fpm [0.30 m/s] True Laminar Down Flow		
	ISO Class 5 Air Protection		
Supply Filter	3 in [76 mm] HEPA 99.99% Efficient @ 0.3 microns		
Pre-Filter Options	Animal Hair / Dander Pre-Filter		Redundant 3 in [76 mm] HEPA 99.99% Efficient @ 0.3 microns Wedge Series
	Deodorizing Charcoal Pre-Filter		
Exhaust Filter	6 in [152 mm] HEPA 99.99% Efficient @ 0.3 microns	11.5 in [292 mm] HEPA 99.99% Efficient @ 0.3 microns	
Control System	AeroMax™		TouchLink™
Pressure / Airflow Sensor	PressureFlow™ Pressure Sensor		Dual IntelliFlow™ Airflow Sensors
Lighting	LED		
	No UV Light Option Available	Ultraviolet (UV) Light Option	
Nitcare™ Compatible	No	Yes	Yes
Password Protection	Yes		
Customizable Blower Schedule	No	Yes	
Decontamination Mode	No	Decon101™	
Noise Level	Up to 67 dba		
Construction Options	Coved Interior Corners		
	Two (2) Duplex Outlets (Back Wall or Front Panel Option)		
	1 and/or 2 Service Couplings (Right/Left Sidewalls)		3 Service Couplings and 1 Service Valve
	Easy-to-Clean Prop-Up Stainless Steel Flat Work Tray	Removable Stainless Steel Covered Work Tray	
		Cord Pass-Through Port (NSF Approved)	
		Easy-to-Clean Prop-Up Work Tray Attachment	
	Frameless Hinged Access Window	Frameless Easy-to-Slide Viewing Window	
	Monolithic 16/18 gauge Stainless Steel Welded Pressure Tight Construction		
	Stainless Steel Spill Trough w/ Drain Valve		
	AttenuMont™ Vibration Control Support System		
	Permanent Positive Pressure Plenum w/ Quick Release Supply Filter Removal		
	Attachable Stainless Steel Armrest	Heavy Duty Plastic Armrest	Stainless Steel Armrest
	Additional Service Valves and/or GFCI Outlets		
	Seismic Brackets (Rear / Floor Mount)		
	Heated Work Surface (Custom)		IV Bar w/ 3 Height Locations, 6 Hooks
Base Stand Options	Motorized Adjustable Base Stand with Built-In Footrest w/ Casters	Motorized Adjustable Base Stand w/ Casters	Telescoping Adjustable Base Stand
			Motorized Adjustable Base Stand
Popular Accessories	Dual or Single Feed Hoppers	Adjustable Ergonomic Footrest	
		Dual or Single Feed Hoppers	Ergotron™ Monitor & Keyboard Mount
	Exhaust Canopy Options		
	Butterfly Exhaust Damper		
Standard Feature		Optional Feature	

*Factory tested to meet NSF/ANSI:49 requirements as a Class II, Type A2 biosafety cabinet.



*Contact your local NuAire distributor for international warranty details.



CLASS II TYPE A2

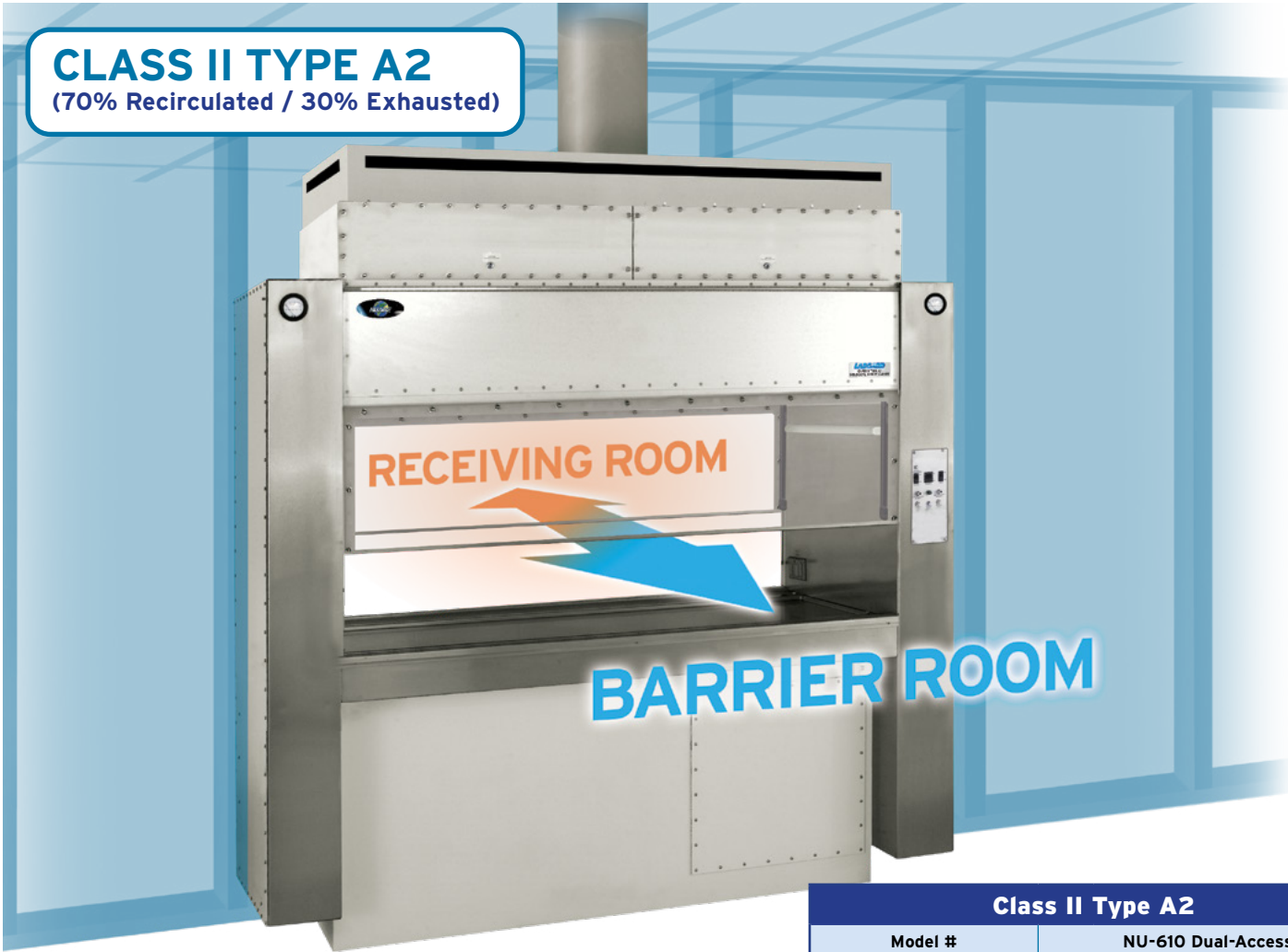

(70% Recirculated / 30% Exhausted)

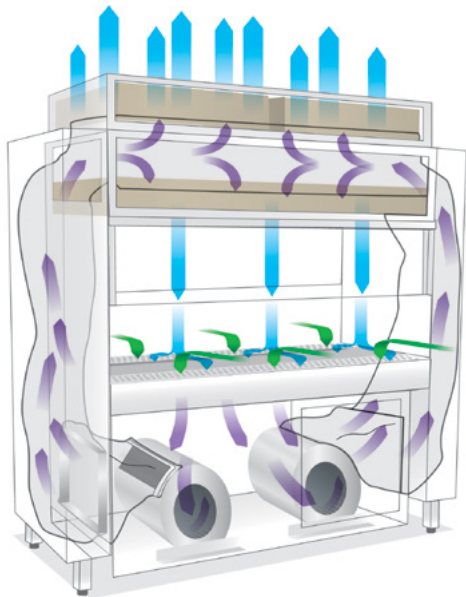

The LabGard® ES (Energy Saver) NU-610 Class II, Type A2 Dual Access Laminar Airflow Biosafety Cabinet is built into the wall of your laboratory, which makes it easy to transfer new animals into a facility or move them between different rooms. NuAire custom builds each NU-610 model to fit your lab's specific needs. The NU-610 uses a Minihelic® pressure gauge to constantly monitor and display airflow pressure within the work zone.



All sizing and feature options are fully customizable to fit your lab's specific needs. The NU-610 is typically built as a Class II Type A2, which normally exhausts back into the room, but this unit is fully capable of connecting directly into your facility's HVAC network. The pass-through system can also be optimized with any NuAire ergonomic options and accessories to ensure your personnel's continued comfort.

-  HEPA Filtered Air
-  Contaminated Work Zone Air
-  Contaminated Room Air

Class II Type A2	
Model #	NU-610 Dual-Access
Certifications	UL listed
Access Opening	12 in [305 mm]
Electrical Requirements	115 VAC / 60 Hz
Filter Load Capacity	150%
Air Barrier	105 fpm [0.53 m/s] Dynamic Air Barrier 60 fpm [0.30 m/s] True Laminar Down Flow ISO Class 5 Air Protection
Supply Filter Options	HEPA 99.99% efficient @ 0.3 microns HEPA H14 99.995% efficient @ MPPS
Pre-Filter Options	Animal Hair / Dander Pre-filter Deodorizing Charcoal Pre-filter
Exhaust Filter Options	HEPA 99.99% efficient @ 0.3 microns HEPA H14 99.995% efficient @ MPPS
Pressure / Airflow Sensor	Minihelic™ Pressure Gauge
Lighting	Fluorescent LED
Noise Level	Up to 67 dba
Construction Options	Removable Stainless Steel Coved Work Tray Easy-to-Clean Prop-Up Work Tray Monolithic Stainless Steel Welded Pressure Tight Attenuum™ Vibration Control Support System Permanent Positive Pressure Plenum w/ Quick Release Supply Filter Removal Additional Service Valves and/or GFCI Outlets Heated Work Surface (Custom)
Popular Accessories	Heavy Duty Plastic Armrest Silicone Cushioned Movable Elbow Rests
	Standard Feature Optional Feature



CLASS II TYPE A2
 (70% Recirculated / 30% Exhausted)

The AutoLabGard® ES (Energy Saver) NU-125 Mini-Room Class II, Type A2 Biosafety Cabinet provides fully customized Class II protection for applications commonly involving robotic automation, cell sorters, ultra-centrifuges, and laboratory equipment requiring Class II protection from harmful aerosols and airborne particles. The NU-125 Mini-Room can fulfill any niche laboratory need that your standard bench top or console BSC cannot meet on its own.

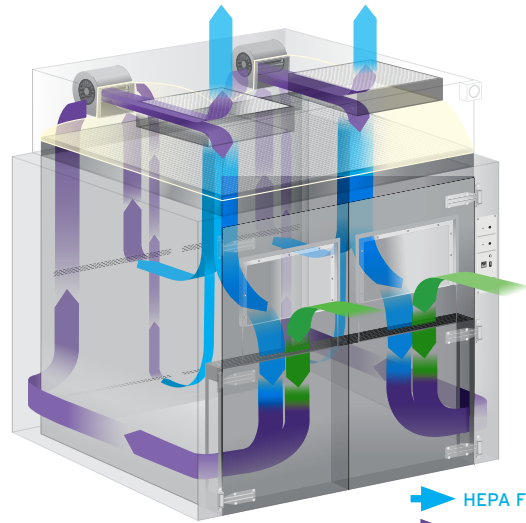

▶ HEPA Filtered Air
▶ Contaminated Work Zone Air
▶ Contaminated Room Air



1 YEAR WARRANTY
 PARTS + LABOR + FILTERS
 United States, Canada



Class II Type A2	
Model #	NU-125 Mini-Room
Certifications	UL listed
Access Opening	10 in [254 mm]
Electrical Requirements	115 VAC / 60 Hz
Filter Load Capacity	150%
Air Barrier	105 fpm [0.53 m/s] Dynamic Air Barrier
	60 fpm [0.30 m/s] True Laminar Down Flow
	ISO Class 5 Air Protection
Supply Filter Options	HEPA 99.99% efficient @ 0.3 microns
	HEPA H14 99.995% efficient @ MPPS
Exhaust Filter Options	HEPA 99.99% efficient @ 0.3 microns
	HEPA H14 99.995% efficient @ MPPS
Pressure / Airflow Sensor	Minihelic™ Pressure Gauge
Lighting	Fluorescent w/ LED Option
	Ultraviolet (UV) Light Option
Noise Level	Up to 70 dba
Construction Options	Coved Interior Corners
	Two (2) Interior Duplex GFCI Outlets
	1 and/or 2 Service Couplings
	Permanent Positive Pressure Plenum w/ Quick Release Supply Filter Removal
	Additional Service Valves and/or GFCI Outlets
Popular Accessories	Sinks with Hot/Cold or DI Water Faucets
	Auto-Rising Heavy-Duty Stainless Steel Work Table w/ Caster Wheels
Standard Feature	Optional Feature

This stainless steel work table can comfortably fit inside the NU-125 work space and comes selectively available with telescoping or auto-rising base options. The work table can be fitted with leg levelers or heavy-duty casters to maximize user comfort and efficiency.



CLASS II TYPE B1

(30% Recirculated / 70% Exhausted)



The LabGuard® ES (Energy Saver) NU-427 Class II, Type B1 Biosafety Cabinet is a bench top model, available with an optional base stand to operate as a console model. Utilizing our single Energy Saver DC ECM motor, the NU-427 greatly increases both energy efficiency and filter load capacity. All NuAire HEPA filters feature an expanded surface area that prolongs their lifespan and lowers operational costs. All HEPA filters are also tested twice during each phase in the manufacturing process. Because Type B1 cabinets recirculate approximately 30% of the air passing through the work zone, the NU-427 can be operated with less energy and exhaust requirements than its Type B2 counterparts. If permissible by your local chemical risk assessment, this unit may also be used for work with minute quantities of volatile chemicals and trace amounts of radionuclides in the directly exhausted portion of the work zone or, as long as it does not interfere with product samples, in the recirculated down flow areas.



- ➡ HEPA Filtered Air
- ➡ Contaminated Work Zone Air
- ➡ Contaminated Room Air

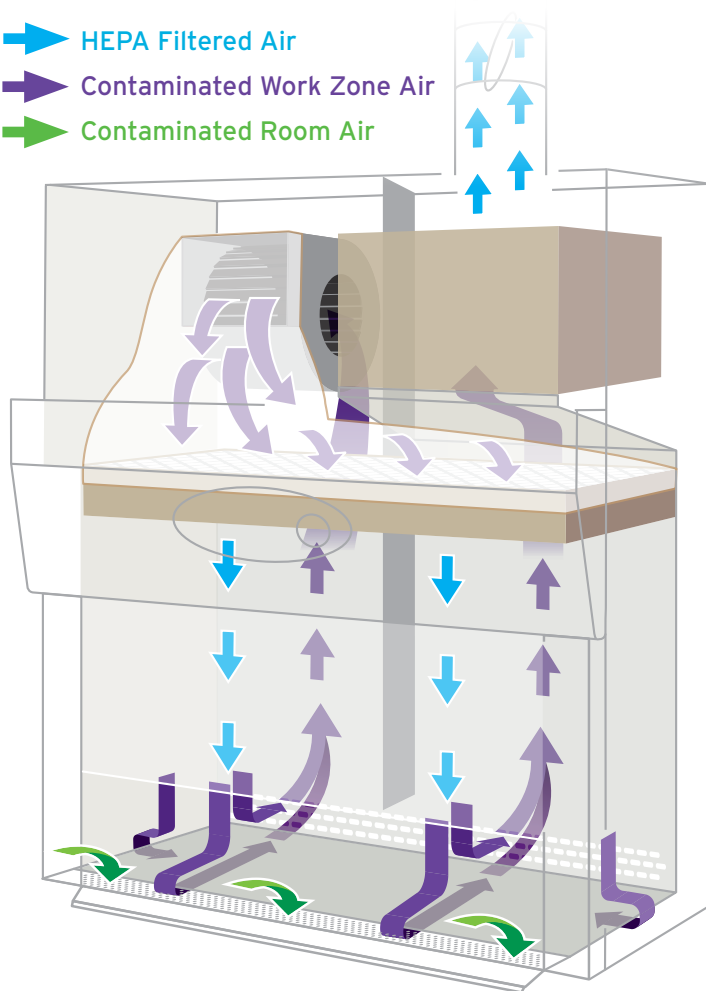



TouchLink™ Electronic Control System

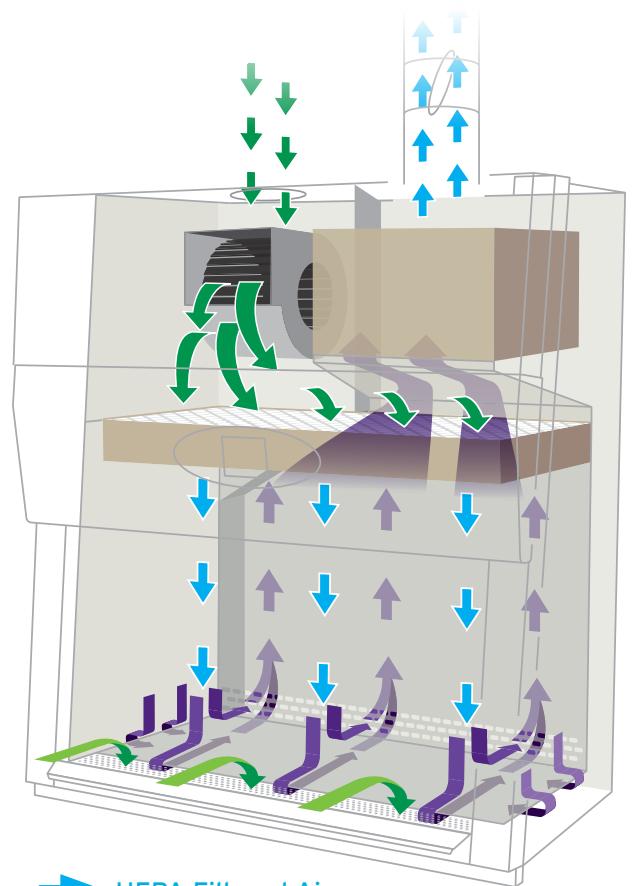

*Optional IV Bar Shown



-  HEPA Filtered Air
-  Contaminated Work Zone Air
-  Contaminated Room Air



TouchLink™ Electronic Control System

The LabGuard[®] ES (Energy Saver) TE (Total Exhaust) NU-560 Class II, Type B2 Biosafety Cabinet is a bench top model, available with several base stand options for operation as a full console model. Since the entire work zone must be 100% exhausted through your facility's internal exhaust network, the NU-560 may be used for work with minute quantities of volatile chemicals and trace amounts of radionuclides. When used with proper technique, the LabGuard[®] NU-560 is an effective primary engineering control. The Type B2 also reduces the risk of product and personnel exposure to airborne biological pathogens or particulate chemical agents in low to moderate risk-hazard environment by creating a dynamic air barrier at the front of the machine.

The NU-560 also features an exhaust interlock system that prevents operation of the BSC unless your facility's HVAC exhaust flow is sufficient enough to provide the necessary inflow velocity to maintain the dynamic air barrier during startup. An externally mounted, energy efficient LED light fixture provides 860 to 1600 LUX on your full work surface and comes standard with every Class II, Type B2 Biosafety Cabinet.

CLASS II TYPE B2 (100% Exhausted)



The LabGard® ES TE (Total Exhaust) NU-565 Class II, Type B2 Biosafety Cabinet and Fume Hood is a bench/table top model, available with an optional base stand for operation as a full console model. This model is designed specifically to meet ASHRAE 110 certification and classified to UL 1805 specifications, so it may be used for work with flammable or volatile chemicals and radionuclides if permitted by chemical risk assessment. Materials located inside or near the work zone are entirely flame resistant; all electronic components are coated in flame retardant and moved to inside the control panel, safely protected from any volatile or corrosive elements. The TouchLink™ electronic control system utilizes a digital thermistor airflow sensor paired with a differential velocity pressure grid that automatically compensate for variances in both filter loading and line voltage to maintain consistent air volume control. As a Class II, Type B2, the NU-565 must be 100% exhausted through your facility's internal exhaust network.



TouchLink™ Electronic Control System

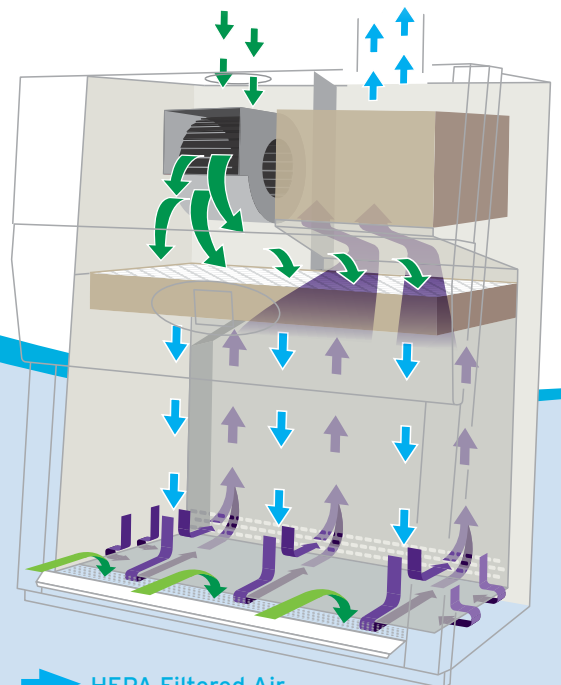

- ➔ HEPA Filtered Air
- ➔ Contaminated Work Zone Air
- ➔ Contaminated Room Air



The Stainless Steel Window Edge Protector helps prevent any chipping or cracking from extended use of your cabinet.



The Ergotron® Arm attaches a keyboard / mouse and computer monitor directly to your cabinet for a more efficient work zone.

Class II Type B1 & B2			
Class, Type	Class II, Type B1		Class II, Type B2
Model #	NU-427	NU-560	NU-565
Cabinet Style	Bench Top w/ Optional Base Stand		
Nominal Widths	4, 6 ft [1.2, 1.8 m]		
Workspace Dimensions (W x D x H)	(46.4 / 70.4) x 23.5 x 25.5 in [(1178 / 1788) x 597 x 648 mm]	(46.4 / 70.4) x 26 x 25.2 in [(1178 / 1786) x 660 x 640 mm]	
Exterior Dimensions (W x D x H)	(53.6 / 77.6) x 32.7 x 62 in [(1362 / 1972) x 830 x 1575 mm]		
Net Weight	427 - 740 lbs [249 - 336 kg]	490 - 680 lbs [222 - 308 kg]	
Certifications	NSF / ANSI 49, UL listed		NSF / ANSI 49, ASHRAE 110, UL 1805
Exhaust Requirements	(282 / 474) CFM @ (0.7 / 0.9) in wg [(479 / 805) CMH @ (18 / 23) mm wg]	(815 / 1385) CFM @ (1.7 / 1.8) in wg [(1275 / 2166) CMH @ (43 / 46) mm wg]	
Access Opening	8 in [203 mm]		
Electrical Requirements	115 VAC / 60 Hz		
Supply Filter Load Capacity	250%		
Air Barrier	105 fpm [0.53 m/s] Dynamic Air Barrier, 60 fpm [0.30 m/s] True Laminar Down Flow, ISO Class 5 Air Protection		
Supply Filter	3 in [76 mm] HEPA 99.99% Efficient @ 0.3 microns		
Exhaust Filter Options	11.5 in [292 mm] HEPA 99.99% Efficient @ 0.3 microns		
	Bag-In/Bag-Out Front Access Module		
Control System / Airflow Sensor	TouchLink™ w/ IntelliFlow™ Airflow Sensor & Digital Differential Velocity Pressure Flow Grid		
Lighting	Fluorescent w/ LED Option	LED	
	Ultraviolet (UV) Light Option		No UV Light Option Available
Nitecare™ Compatible	Yes		
Password Protection	Yes		
Customizable Blower Schedule	Yes		
Decontamination Mode	Decon101™		
Noise Level	Up to 63 dba		
Construction Options	1 Duplex Outlet (Front Panel)		
	3 Service Couplings and 1 Service Valve (Right/Left Sidewalls or Front Panel)		
	Cord Pass-Through Port (Left Sidewall; NSF Approved)		
	Prop-Up Stainless Steel Covered Work Tray	Prop-Up Stainless Steel Covered Work Tray	
		Coved Interior Corners	
	Frameless Easy-to-Slide Viewing Window		
	Monolithic 16/18 gauge Stainless Steel Welded Pressure Tight Construction		
	Recessed & Removable Front Intake Grill		
	Stainless Steel Spill Trough w/ Drain Valve		
	AttenuMont™ Vibration Control Support System		
	Permanent Positive Pressure Plenum w/ Quick Release Supply Filter Removal		
	Heavy Duty Plastic Armrest w/ Stainless Steel Option		
	IV Bar w/ 3 Height Locations + 6 SST Hooks		
	Built-In Plumbing (Right/Left Sidewalls)		
	Additional Service Valves, Couplings, and/or GFCI Outlet		
	Base Stand Options	Seismic Brackets (Rear / Floor Mount)	
Stainless Steel Viewing Window Edge Protector			
Telescoping Adjustable Base Stand w/ Leg Levelers or Casters			
Motorized Adjustable Base Stand w/ Leg Levelers or Casters			
Popular Accessories		Adjustable Ergonomic Footrest	
	Silicone Cushioned Movable Elbow Rests		
	Ergotron™ Monitor, Keyboard, and Mouse Mount		
	Storage Pull-Out Trays or Shelves		
	12 in [305 mm] Flex Duct Kit		
	12 in [305 mm] Airtight Butterfly Valve		
	Standard Feature		Optional Feature



*Contact your local NuAire distributor for international warranty details.



CUSTOM SOLUTIONS

Engineered to Your Lab's Specific Needs

In every NuAire product you'll find brilliant yet practical design with keen attention to detail in every phase of the fabrication and assembly process; you'll always receive thoroughly tested equipment at outstanding value, and with dependable customer service guaranteed. These are the fundamentals for NuAire's international reputation and the reasoning behind our universal recognition as the world's finest. Despite our engineers' finely honed genius, your lab may require something that has never been done before. Luckily, our custom sales department has nearly half a century's worth of experience in crafting all sorts of new and innovative lab equipment to meet your specific

needs. We routinely reshape our cabinet's inner and outer dimensions to neatly fit within any space inside your lab. We often add computer arms, monitors, and microscope windows into our standard cabinets, as well. Another common customization involves installing an IV bar and smooth interiors for efficient and ergonomic pharmacy compounding. Regardless of what type of modification your lab and research may require, NuAire is capable of meeting any esoteric laboratory need and provide you with excellent troubleshooting support for years to come, ensuring your custom equipment continues to perform at peak levels for the entirety of its lifespan.

If your lab requires a unique solution, give us a call; we love a challenge.



This Class I BSC was created at a nominal width of 8' [2.4 m], with clear polypropylene sidewalls, and a custom mounted IV bar.



This LabGuard BSC was fitted with a microscope viewing window to accommodate workflow specializing in human cell tissue research.



A custom model NU-240 was designed to offer a broader and taller work zone to accommodate a single workflow process involving microscopes. A customized isolation table was added to eliminate vibration in the work surface. The extended work surface allows a technician to perform several protocols without having to leave the work zone.

INDUSTRY APPLICATIONS

Equipment to Fit Any Field of Research & Development

For decades, NuAire technology has inspired professionals in life science, drug discovery, pharmacy, microbiology, and across many other disciplines. NuAire products are also ideal for many sub-specialties within larger areas of expertise. If you are unsure of exactly what products are best suited for your needs, please contact our customer support line for more information at any time.



LabGard NU-813

Class I / Containment Ventilated Enclosure
Protection: Personnel
Exhaust: Optional with Transition
Controls: AeroMax
Access Opening: 8 in [203 mm]

Research / Pharmacy Applications



LabGard NU-540

Class II Type A2 Biosafety Cabinet
Protection: Personnel, Product, Environmental
Airflow: 70% Recirculated / 30% Exhausted
Exhaust: Optional with Transition
Controls: AeroMax
Access Opening: 8, 10 in [203, 254 mm]



LabGard NU-543

Class II Type A2 Biosafety Cabinet
Protection: Personnel, Product, Environmental
Airflow: 70% Recirculated / 30% Exhausted
Exhaust: Optional with Transition
Controls: FlowGard
Access Opening: 8, 10, 12 in [203, 254, 305 mm]



LabGard NU-545

Class II Type A2 Biosafety Cabinet
Protection: Personnel, Product, Environmental
Airflow: 70% Recirculated / 30% Exhausted
Exhaust: Optional with Transition
Controls: TouchLink
Access Opening: 8, 10 [203, 254 mm]



LabGard NU-427

Class II Type B1 Biosafety Cabinet
Protection: Personnel, Product, Environmental
Airflow: 30% Recirculated / 70% Exhausted
Exhaust: Hard Duct
Controls: TouchLink
Access Opening: 8 in [203 mm]



LabGard NU-560

Class II Type B2 Biosafety Cabinet
Protection: Personnel, Product, Environmental
Airflow: 0% Recirculated / 100% Exhausted
Exhaust: Hard Connection
Controls: TouchLink
Access Opening: 8 in [203 mm]



LabGard NU-565

Class II Type B2 Biosafety Cabinet
Protection: Personnel, Product, Environmental
Airflow: 0% Recirculated / 100% Exhausted
Exhaust: Hard Connection
Controls: TouchLink
Access Opening: 8 in [203 mm]

Animal Handling



LabGard NU-640

Class II Type A2 Biosafety Cabinet
Protection: Personnel, Product, Environmental
Airflow: 70% Recirculated / 30% Exhausted
Exhaust: Optional with Transition
Controls: AeroMax
Access Opening: 14 in [356 mm]



LabGard NU-677

Class II Type A2 Biosafety Cabinet
Protection: Personnel, Product, Environmental
Airflow: 70% Recirculated / 30% Exhausted
Exhaust: Optional with Transition
Controls: AeroMax
Access Opening: 12 in [305 mm]



AllerGard NU-608

Class I / Containment Ventilated Enclosure
Protection: Personnel
Airflow: 100% Exhausted
Exhaust: Optional with Transition
Access Opening: 14.4 in [366 mm]

Cytotoxic / Hazardous Powders



LabGard NU-581

Class II Type A2 Biosafety Cabinet
Protection: Personnel, Product, Environmental
Airflow: 70% Recirculated / 30% Exhausted
Exhaust: Optional with Transition
Controls: TouchLink
Access Opening: 8, 10 in [203, 254 mm]

Robotics / Large Equipment



LabGard NU-125

Class II Type A2 Biosafety Cabinet
Protection: Personnel, Product, Environmental
Airflow: 70% Recirculated / 30% Exhausted
Exhaust: Optional with Transition
Access Opening: Customizable

POPULAR ACCESSORIES

Add and Extend Your Lab's Capabilities

Personalize Your NuAire Laboratory Equipment for Extra Comfort and Versatility. Any NuAire biosafety cabinet can be customized for any scientific application while preserving user comfort and safety for the entire day.

BSC Base Stands Options

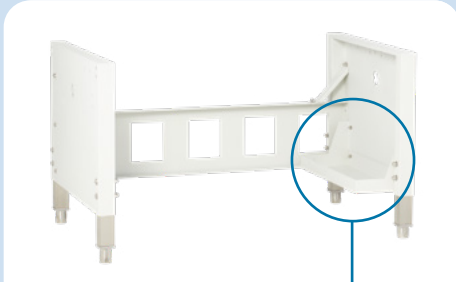

Telescoping Base Stand
w/ Leg Levelers or Casters
Optional Shelf Attachment
8 or 12 in [203 or 305 mm]



Motorized Base Stand
w/ Leg Levelers or Casters
(No Available Shelf Attachments)

Ergonomics & Workflow



Ergotron™ Arm

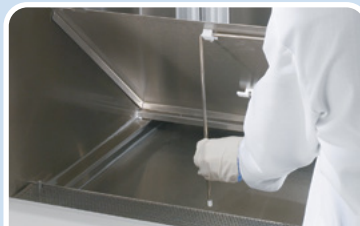

Work Tray Prop-up Bar



Forearm Armrest Pad



Stainless Steel Turntable

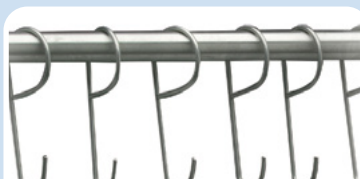

IV Bar w/ 6 Hooks
Three (3) Bar Height Options



Microscope Viewing Window



Adjustable Foot Rest

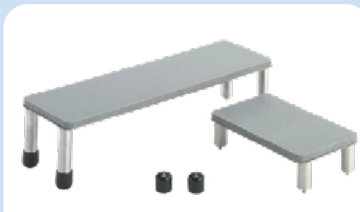

Padded Elbow Rests
5 or 10 in [127 or 254 mm]



Independent Airflow Alarm

Construction Options

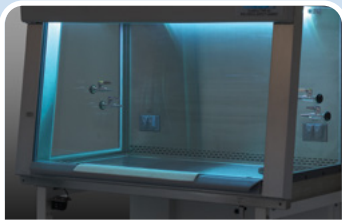

Ultraviolet (UV) Light



Cord Pass-thru
(NSF Approved)



Interior LED Lighting
(Replaces Fluorescent Lighting)



Service Valves/Couplings



Duplex/GFCI Outlets

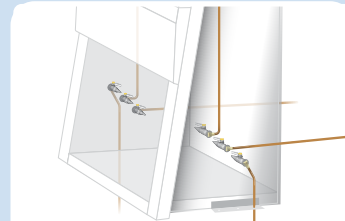

Pre-piped Plumbing



Animal Feed Hopper

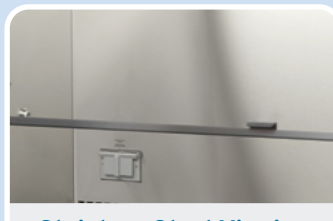

**Stainless Steel Viewing
Window Edge Protector**

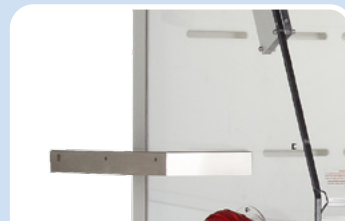

Side-Mounted Shelf

Exhausting & Transitions

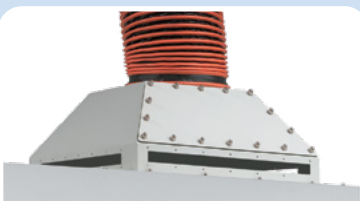

**Fixed Exhaust
Canopy Transition**



**Manual / Automatic
Butterfly Valves**

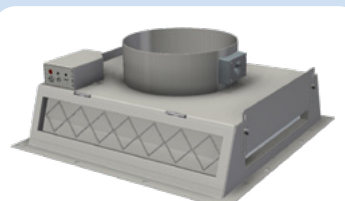

**Variable Flow Canopy (VFC)
Exhaust Transition w/ Alarm**



Round Transition Duct
8 - 10 in [204 - 254 mm]



Flex Duct
6 - 12 in [152 - 305 mm]



**Silicone Sleeve
Connection Kit**

COMPLETE YOUR LABORATORY

Add and Extend Your Lab's Capabilities

NuAire manufactures scientific laboratory equipment and compounding pharmacy airflow products, which provide personnel, product, and environmental protection in critical research facilities throughout the world. Continue your journey with the NuAire family by completing your laboratory with the full suite of NuAire quality products.



NUWIND
Centrifuges



LABGARD
Biosafety Cabinets



IN-VITROCELL
CO₂ Incubators



AIREGARD
Laminar Airflow Workstations



ALLERGARD
Animal Handling Stations



BLIZZARD
Ultralow Freezers



PHARMAGARD
Compounding Isolators



Polypropylene Fume Hoods
and Casework



Custom Solutions



Fernbrook
& Niagara
Locations



NuAire, Inc. | 2100 Fernbrook Lane | Plymouth, MN 55447 | U.S.A. | www.nuaire.com

LABGUARD®

BIOSAFETY CABINETS



The Safer Choice

For more information please visit:

www.nuaire.com or call **1.800.328.3352**



Your Local NuAire Partner:



ISO 13485:2016 Fernbrook
ISO 9001:2015 & Niagara
CERTIFIED Locations



Learn More or
Request a Quote Online
www.nuaire.com