

REV	LOG	DESCRIPTION	DATE	BY	CHKD
B	13441	UPDATED	7/7/2017	TH	BP

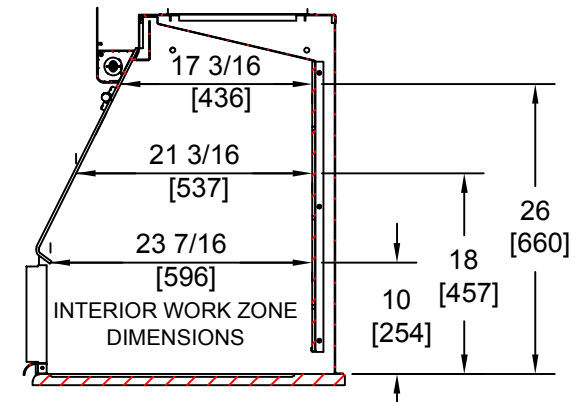
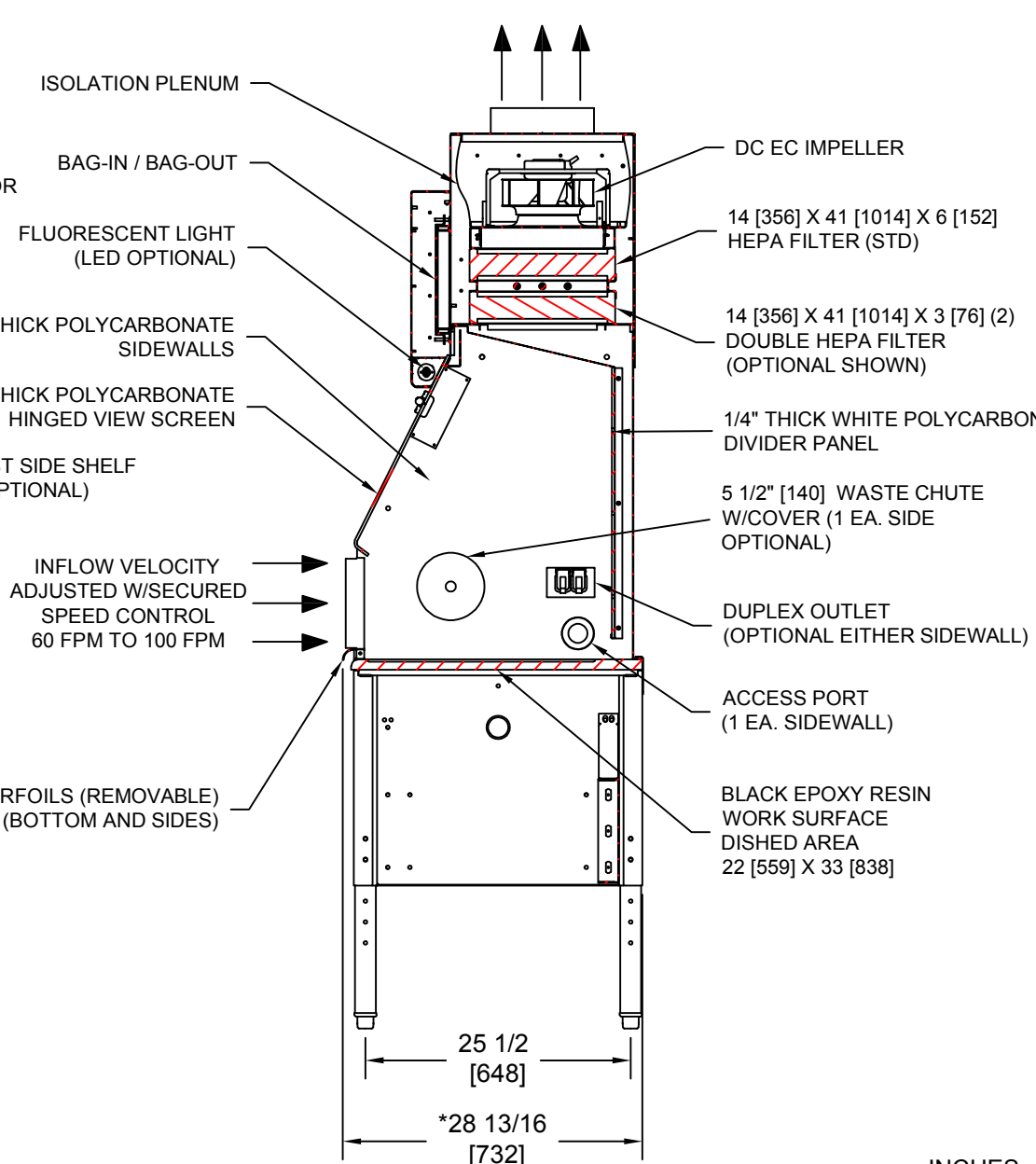
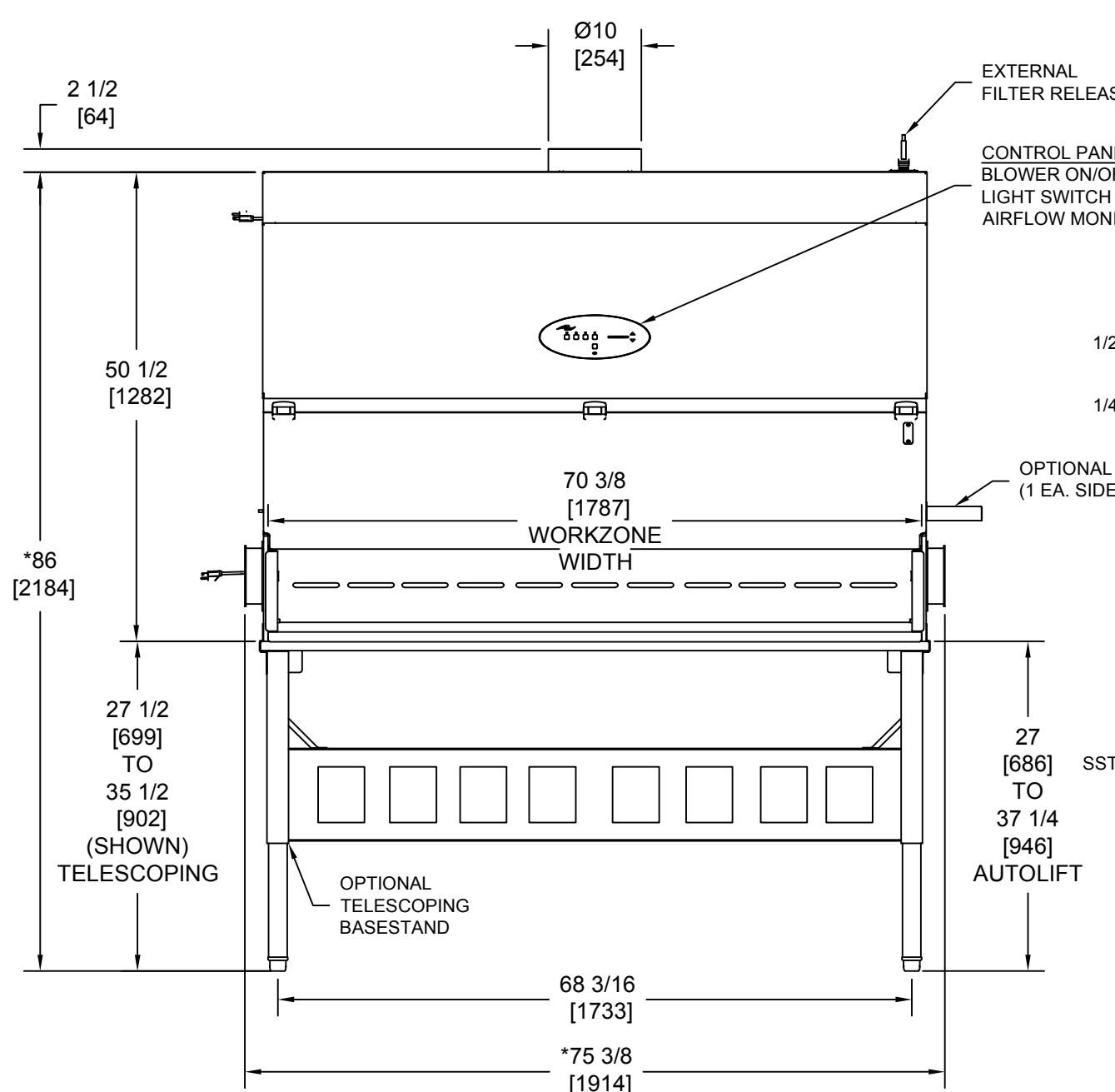
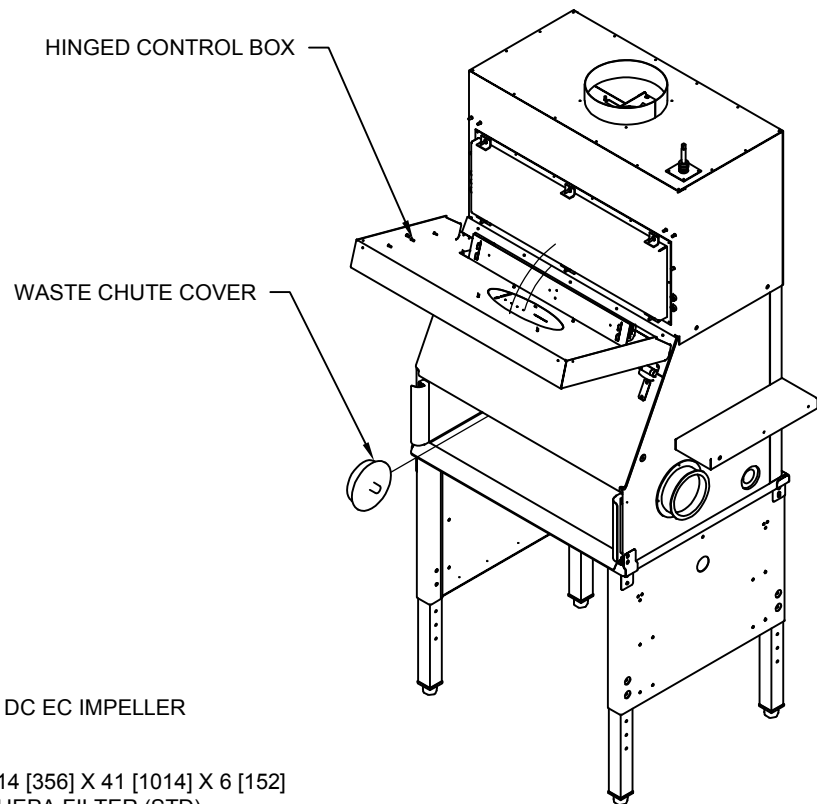
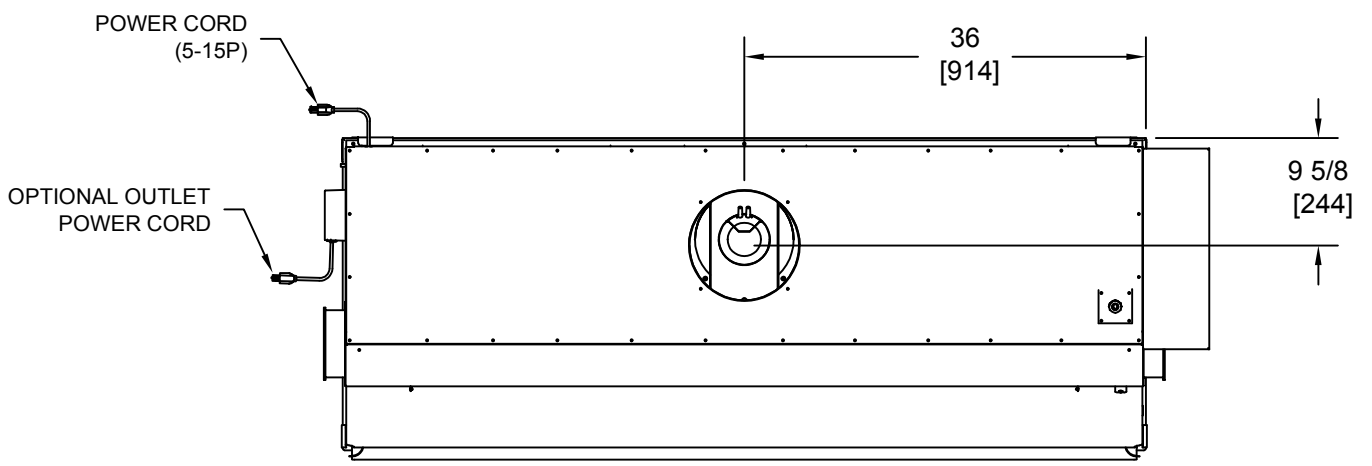

NOTES:
 1. * OVERALL DIMENSIONAL TOLERANCE ±1/4[6.35]
 ALL OTHER DIMENSIONS ±1/8[3.17].
 2. ALL ITEMS STANDARD UNLESS OTHERWISE SPECIFIED AS OPTIONAL.

NU-813-600 SERIES 32 CONTAINMENT VENTILATED ENCLOSURE					
DFTM	LS	11/16/16	CHKD	MSS	SHEET 1 OF 1
DRAWING NUMBER		BCD-18731			B

INCHES
MILLIMETER