

**LabGard® ES Energy Saver Class II,
Type B2 Laminar Flow
Biosafety Fume Hood/Cabinet**

**Models
NU-565-400/600
Bench/Console**

Operation & Maintenance Manual

**(Series C)
Revision 2
November 2021**



Manufactured By:
Nuaire, Inc.
2100 Fernbrook Lane
Plymouth, MN 55447
Toll-Free: 1-800-328-3352
In Minnesota: (763)-553-1270
Fax: (763)-553-0459

Congratulations!

You have just purchased one of the finest Laminar Flow Biosafety Fume Hood/Cabinets available. With proper care, maintenance (certification), and laboratory procedure, this cabinet will give you years of product and personnel protection from particulate contaminants as prescribed in NSF/ANSI 49. Please read this manual carefully to familiarize you with proper installation, maintenance and operation of the cabinet. Other reference and guideline materials are available through the following web sites.

www.hc-sc.gc.ca

www.cdc.gov/od/ohs/

www.absa.org

www.absa-canada.org

www.ebsa.be

www.inspection.gc.ca

www.who.int

www.biosafety.be

www.hse.gov.uk

www.nsf.org

www.cetainternational.org

www.osha.gov/dts/osta/

www.Nuaire.com

ABOUT THIS OPERATION & MAINTENANCE MANUAL

The information contained in this manual is intended to reflect our current production standard configuration model along with the more frequently purchased options. Any unique additions/modifications/shop drawings are appended in the back flap of this manual, along with any modifications and/or additions to procedures as outlined in this manual. A copy of the original factory test report is also appended to this manual. In case this manual and/or test report is lost or misplaced, Nuairé retains a copy in our files. A replacement copy can be obtained by calling or writing Nuairé, Inc. stating the model number and serial number and a brief description of the information desired.

LabGard® ES Energy Saver Class II, Type B2 Laminar Flow Biosafety Fume Hood/Cabinet
Models NU-565-400/600 Operation & Maintenance Manual

TABLE OF CONTENTS

Section No. 1 General Information
Section No. 2 Models & Features
Section No. 3 Warranty
Section No. 4 Shipments
Section No. 5 Installation Instructions
 5.1 Location
 5.2 Set-up Instructions
 5.3 Exhaust/Supply Air Checks
 5.4 Certification Testing Methods and Equipment
Section No. 6 Operating the NU-565
 6.1 Biosafety Fume Hood/Cabinet Control
 6.2 Operating Guidelines
 6.3 Operating Sequence
 6.4 Ergonomics
 6.5 Cleaning Procedures
 6.6 Hazardous Drug Decontamination Procedure
Section No. 7 General Maintenance
 7.1 Decontamination
 7.2 Fluorescent Lamp Bulb Replacement
 7.3 HEPA Filter/Motor Replacement
 7.4 Sliding Window Replacement & Adjustment
 7.5 Airflow Control System Setup & Calibration
 7.6 HEPA Filter Leak Test
 7.7 Airflow Smoke Pattern Test
 7.8 Site Installation Assessment Tests
 7.9 Cleanliness Classification Test for Pharmacy Application
 7.10 Main Control Board Description & Replacement
 7.11 Digital Airflow Sensor Description & Replacement
Section No. 8 Error Indicators, Troubleshooting, Option-Diagnostics &
 Airflow Sensor Performance Verification
Section No. 9 Remote Contacts
Section No. 10 Optional Equipment
 10.1 Ultraviolet Light
Section No. 11 Electrical/Environmental Requirements
Section No. 12 Disposal and Recycle

MANUAL DRAWINGS

ACD-19028 NU-565 Airflow Schematic
BCD-20051 NU-565-400 Class II Type B2 Biosafety Fume Hood
BCD-20052 NU-560-600 Class II Type B2 Biosafety Fume Hood
BCD-16300 Drain Valve Installation
BCD-05572 Butterfly Valve Installation
BCD-05660 Bag In/Bag Out Procedure

ASSEMBLY DRAWINGS

BCD-16633 Base Stand Assembly
BCD-19031 Control Center & Front Decorative Panel Assembly
BCD-16376 Sliding Window Assembly & Adjustment
BCD-19032 Base Cabinet Assembly

ELECTRICAL SCHEMATICS

CD-000046 (sheets 1-3) NU-565-400/600 Electrical Schematic

**LabGard® ES Energy Saver Class II,
Type B2 Laminar Flow
Biosafety Fume Hood/Cabinet
Models
NU-565-400/600
MANUFACTURED BY:
Nuair, Inc. - Plymouth, Minnesota, U.S.A.**

1.0 General Information

1.1 Description

The LABGARD® ES Model NU-565 Laminar Flow Biosafety Fume Hood/Cabinet (LFBSC) is a bench/table top model, optionally available with a base support stand, for operation as a console model. The LABGARD® ES model NU-565 utilizes an Energy Saver DC ECM motor optimally determined forward curved fan for each model size/width to maximize both energy efficiency and filter loading capacity. The Energy Saver ECM motor is controlled to airflow setpoints via a solid-state DC motor controller with digital dual thermistor airflow sensors that provide an automatic compensation (constant volume control) for both filter loading and line voltage variances.

The Laminar Flow Biosafety Fume Hood/Cabinet, (LFBSC) is a product resulting from the development of the "laminar flow" principle and the application of environmental controls as required in the field of biological research or chemical containment. The LFBSC, when used with proper technique, is an effective laboratory aid in obtaining the optimum control over product quality while reducing the potential for exposure of both product and personnel to airborne biological or particulate chemical agents in low to moderate risk-hazard research and drug preparation or product operations, as prescribed by the Center for Disease Control (CDC) Atlanta, Georgia.

The NU-565 Bench LFBSC meets the requirements of a Class II, Type B2 since the cabinet conforms to the following requirements:

- Maintain a minimum average inflow velocity of 100 fpm (0.51m/s) through the work access opening;
- Have HEPA filtered downflow air drawn from the laboratory or the outside air (i.e. downflow air is not re-circulated from the cabinet exhaust air);
- Exhaust all inflow and downflow air to the atmosphere through a hard connection to the facility exhaust system after filtration through a HEPA filter without recirculation in the cabinet or return to the laboratory;
- Have all contaminated ducts and plenums under negative pressure or surrounded by directly exhausted (non-re-circulated through the work area) negative pressure ducts and plenums.

Type B2 Biosafety Fume Hood/Cabinet classified to UL 1805 may be used for work with flammable or volatile chemicals and radionuclides required if permitted by chemical risk assessment.

1.2 Safety Instructions

These safety instructions describe the safety features of the LABGARD® ES Model NU-565 LFBSC.

The biosafety fume hood/cabinet has been manufactured using the latest technological developments and has been thoroughly tested before delivery. **However, the cabinet may present potential hazards if it is not installed and used as instructed for its intended purpose or outside of operating parameters.** Therefore, the following procedures must always be observed:

- The biosafety fume hood/cabinet must be operated only by trained and authorized personnel.
- For any operation of this cabinet, the operator must prepare clear and concise written instructions for operating and cleaning, utilizing applicable safety data sheets, plant hygiene guidelines, and technical regulations, in particular.
 - Which decontamination measures are to be applied for the cabinet and accessories?
 - Which protective measures apply while specific agents are used?
 - Which measures are to be taken in the case of an accident?
- Repairs to the device must be carried out only by trained and authorized expert personnel.
- Keep these operating instructions close to the cabinet so that safety instructions and important information are always accessible.
- Should you encounter problems that are not detailed adequately in the operating instructions, please contact your Nuair Representative of Nuair technical Services.

1.3 Explanation of Symbols



Safety alert symbol indicates a potentially hazardous situation which, if not avoided, could result in death of serious injury.

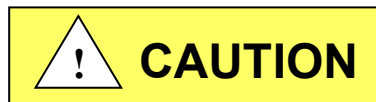

Safety alert symbol indicates a potentially hazardous situation which, if not avoided, may result in minor or moderate injury.

CAUTION

CAUTION used without the safety alert symbol indicates a potentially hazardous situation which, if not avoided, may result in property damage.



Potential electrical hazard, only qualified person to access.

 NOTE:

Used for important information.



Biohazard



Flammable Hazard



Ground, Earth



Hazardous Gases! Personal Protection Equipment Required.



Lead Free



Chemical Hazard

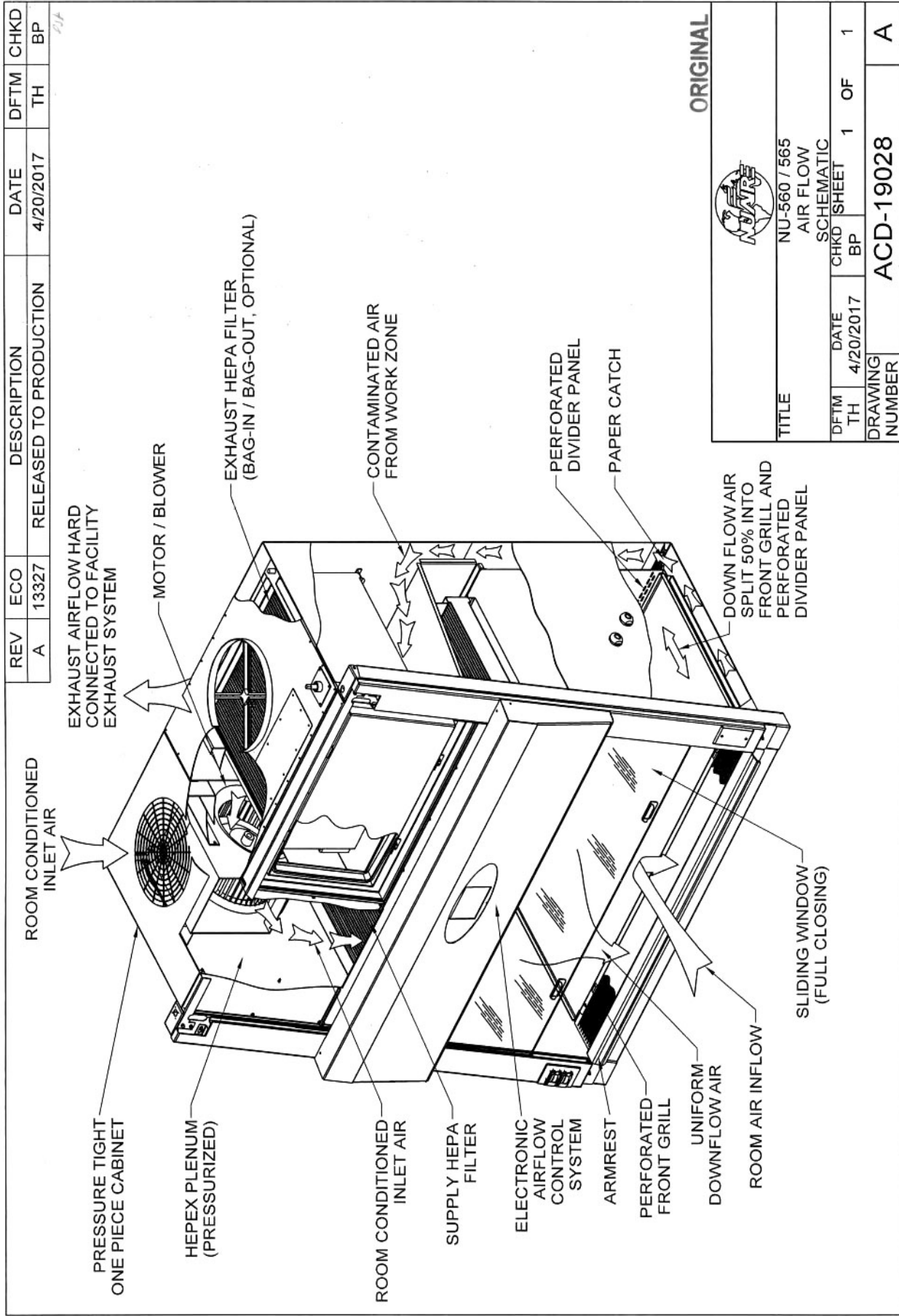

ORIGINAL

		NU-560 / 565 AIR FLOW SCHEMATIC	
TITLE	DATE	CHKD	SHEET
	4/20/2017	BP	1 OF 1
DFTM	TH	DRAWING NUMBER	A
		ACD-19028	

2.0 Models & Features

The model NU-565, LABGARD® ES Class II, Type B2 Laminar Flow Biosafety Fume Hood/Cabinet is manufactured in two sizes: 4 ft. (1.2m) and 6 ft. (1.8m).

REV	CO	DESCRIPTION	DATE	DFTM	CHKD
B	000147	UPDATED	10/7/2019	TH	DSH

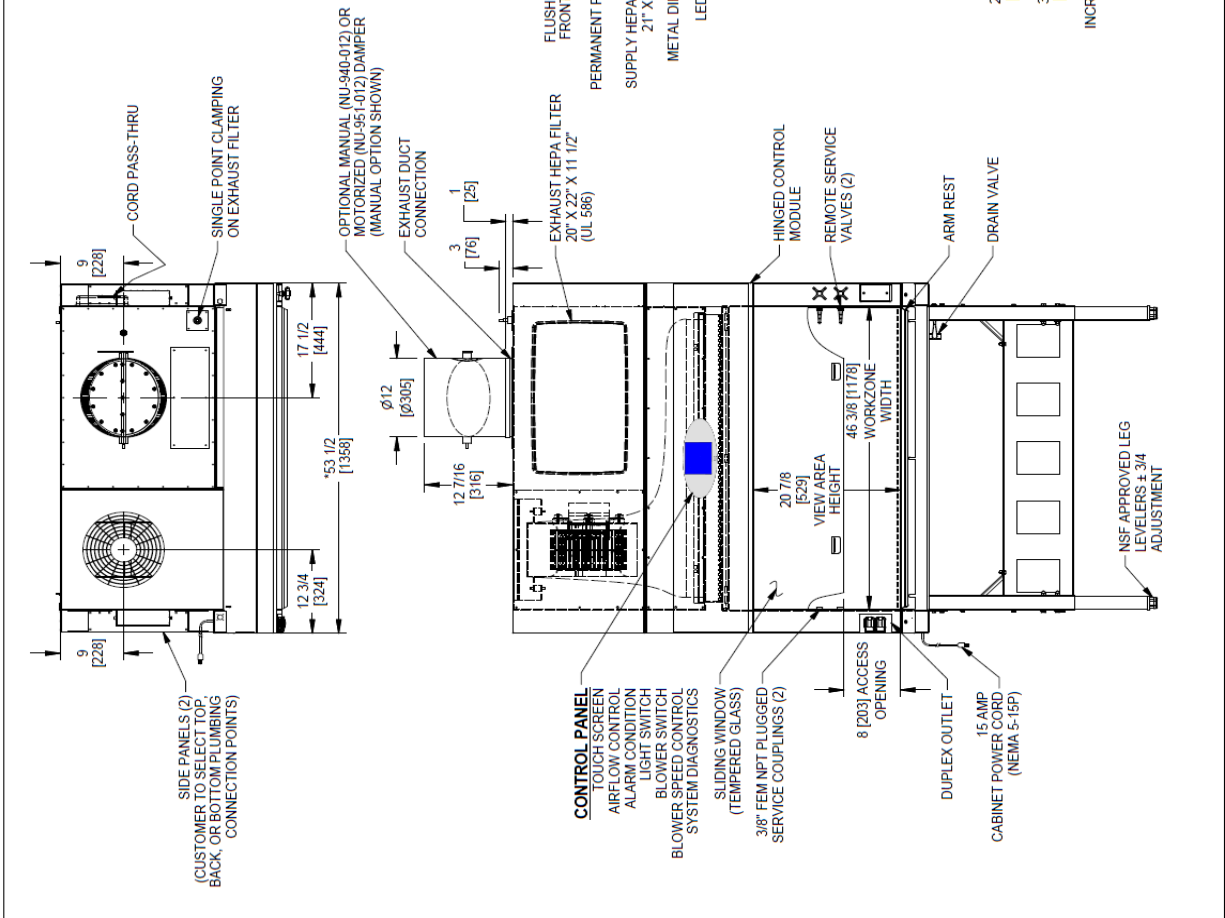

* OVERALL DIMENSIONAL TOLERANCE ±1/4 [6.35]
ALL OTHER DIMENSIONS ±1/16 [3.17]



TITLE				NU-565-400 Class II Type B2 Biosafety Fume Hood		
DFTM	DATE	CHKD	SHEET	1	OF	1
LS	5/21/2018	BP	DRAWING NUMBER			BCD-20051
					INCH	B
					MILLIMETER	

REV	CO	DESCRIPTION	DATE	DFTM	CHKD
B	000147	UPDATED	10/7/2019	TH	DSH

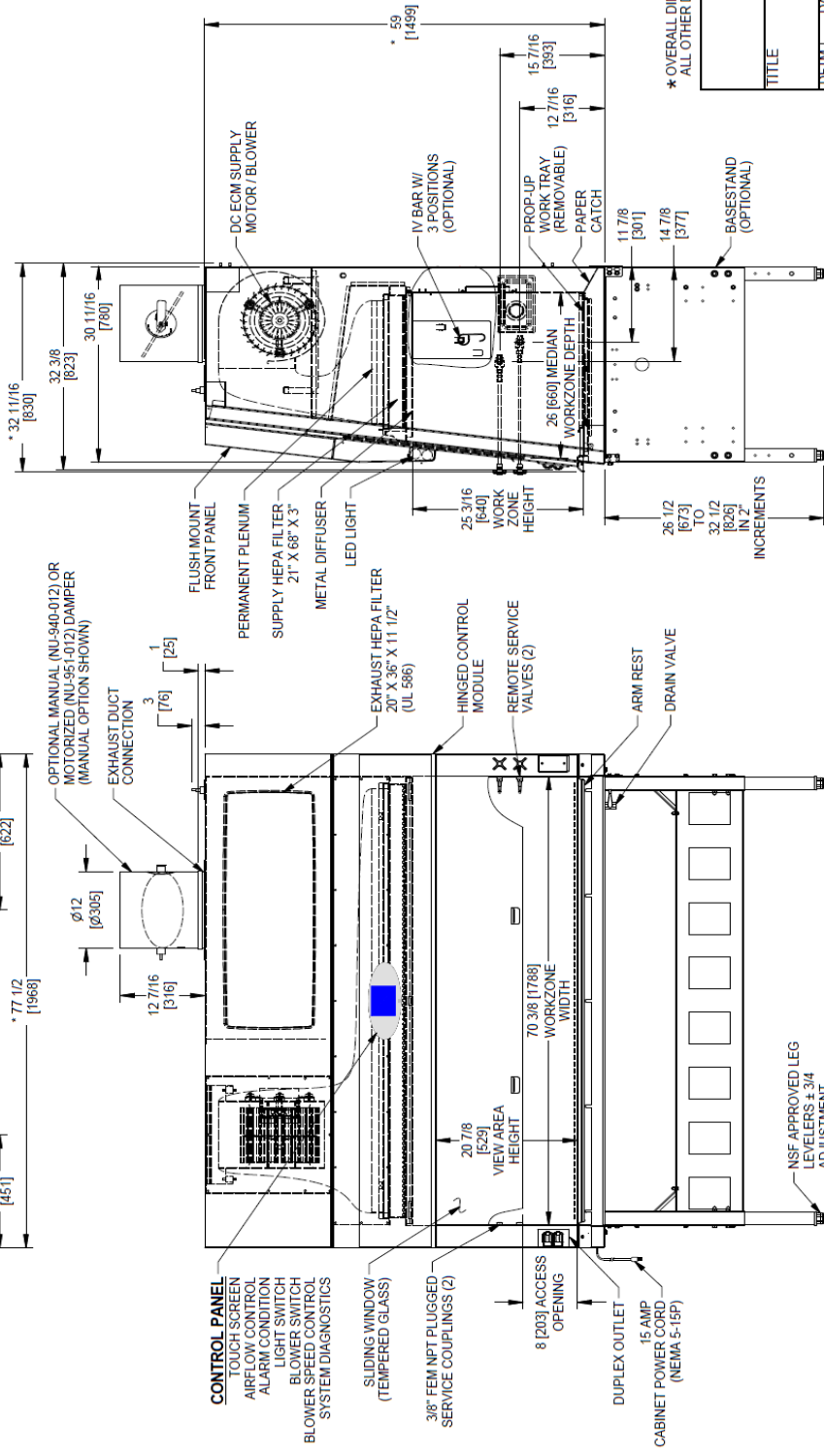
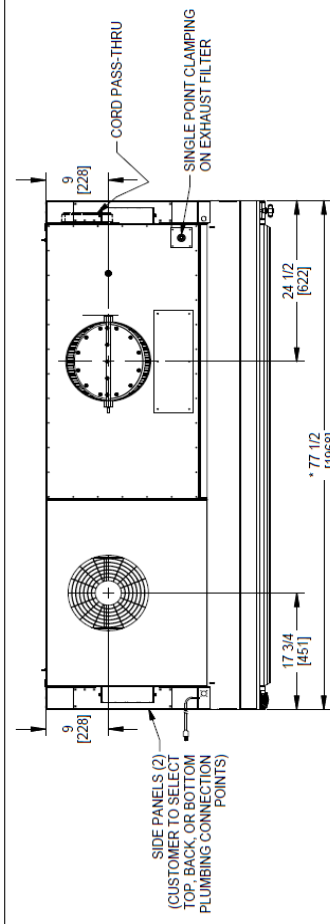

* OVERALL DIMENSIONAL TOLERANCE ± 1/4 [6.35]
 ALL OTHER DIMENSIONS ± 1/8 [3.17]

TITLE		NU-560-600 Class II Type B2 Biosafety Fume Hood	
DFTM	DATE	CHKD	SHEET 1 OF 1
LS	5/21/2018	BP	
DRAWING NUMBER		BCD-20052	
INCH		MILLIMETER	
		B	

3.0 Warranty

Details regarding product warranties can be found in the published warranty data separate from this manual and included within the data packet sent with the unit.

4.0 Shipments

Nuaire takes every reasonable precaution to assure that your LABGARD® ES cabinet arrives without damage. Motor carriers are carefully selected and shipping cartons have been specially designed to insure your purchase. However, damage can occur in any shipment and the following outlines the steps you should take on receipt of a Nuaire LABGARD® ES cabinet to be sure that if damage has occurred, the proper claims and actions are taken immediately.

4.1 Damaged Shipments

- 4.1.1 Terms are factory, unless stated otherwise. Therefore, it is important to check each shipment before acceptance.
- 4.1.2 If there is visible damage, the material can be accepted after the driver makes a notation on the consignee's copy of the freight bill. Then an inspection must be made to verify the claim against the carrier. This inspection is the basis of your filing the claim against the carrier.
- 4.1.3 If concealed damage is found it is absolutely necessary to NOTIFY THE FREIGHT AGENT AT ONCE and request an inspection. Without this inspection, the transportation company may not accept a claim for loss or damage. If the carrier will not perform the inspection, an affidavit must be prepared stating that he was contacted on a certain date and that he failed to comply with the request. This along with other papers in the customer's possession will support the claim.

5.0 Installation Instructions

5.1 Location

Within the laboratory, pharmacy, etc., the ideal location of the Biosafety Fume Hood/Cabinet is away from personnel traffic lanes, air vents (in or out), doors and/or any other source of disruptive air currents.

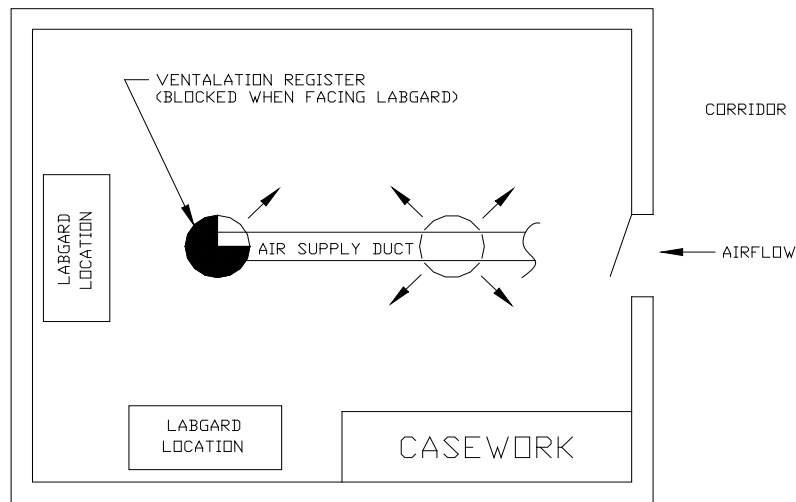

If drafts or other disruptive air currents exceed the inflow velocity of the cabinet through the access opening, the *potential* exists for contaminated air to exit or enter the work zone area of the cabinet. It depends on the severity of the air current. **REMEMBER: A BIOSAFETY FUME HOOD/CABINET IS NO SUBSTITUTE FOR GOOD LABORATORY TECHNIQUE.**

Where space permits, a clear 6 inch (152mm) area should be permitted on each side of the cabinet for maintenance purposes. The electrical outlet into which the cabinet is connected should be readily accessible for maintenance purposes. **Do not position the cabinet to prevent access to the power cord.** The power cord plug serves as the disconnect and should remain readily accessible. If the outlet is inaccessible, such as a conduit (hardwired) connection, then an appropriate warning label should be applied near the cabinet's on/off switch, to indicate the circuit breaker on the power distribution panel to be used.

More than any other Biosafety Fume Hood/Cabinet, the NU-565 requires careful site-planning and preparation, due to the total exhaust nature of the cabinet. Proper sizing of the exhaust and make up supply systems are critical to the successful installation of the cabinet. In addition, the cabinet provides for the choice of make-up air for the supply (downflow) air. The following are airflow requirements based on concurrent balance values*.

<u>Air Volume (CFM/CMH)</u>	<u>Supply Air</u>	<u>Inflow</u>	<u>Exhaust Air**</u>
NU-565-400	544 / 924	271 / 461	815 / 1385
NU-565-600	865 / 1470	410 / 697	1275 / 2166

***Concurrent Balance Value** is determined by a duct traverse measurement method as specified in ASHRAE Standard 111 at its nominal setpoint calibrated using the primary DIM method and capture hood removed. These values shall be used for design and balance exhaust/supply HVAC requirements.

**Exhaust air volume at negative 1.7 inches (43mm) w.g. for NU-565-400
1.8 inches (46mm) w.g. for NU-565-600

5.2 Set-Up Instructions

Remove outer shipping protection (carton or crating). The cabinet is fastened to the base skid and it is usually the best procedure to leave the skid in place until the cabinet is located in its approximate position to facilitate ease in handling. It can then be removed from the skid by removing the banding holding the cabinet to the skid. It may be necessary to remove the Control Center in order to gain passage through a doorway. It may easily be removed by following the instructions on drawing BCD-19031.



It is recommended that no less than two people are present using a lifting system for placement of the cabinet onto the base stand. It is not recommended to manually lift the cabinet onto the base stand.

5.2.1 Base Stand Assembly

The base stand is shipped knocked down in a separate carton and is assembled per drawing BCD-16633 if accompanied with the cabinet. Remove the banding holding the cabinet to the base skid. Lift the cabinet from the base skid and place on the floor. Now lift the cabinet on top of the base and bolt the base stand to the cabinet using two 3/8" - 16 x 3/4" bolts and washers provided for the front base stand tabs and two 1/4" acorn nuts for the rear weld studs. Place the cabinet in its desired location.

The base stand storage cabinets will usually be shipped according to customer requirements. If it is shipped unassembled, it can be assembled per drawing BCD-16633. It is recommended that the upper and lower base stand braces be installed first, then the rear and bottom panels (the end panels are always prefastened). Once assembled, fasten the cabinet per the above instructions.

Remove the cap protecting the drain valve threads and install the drain valve, on the bottom right front of the cabinet using Loctite 242 furnished to the threads and rotate the valve body until it is secure (See BCD-16300).

5.2.2 Leveling

Using a level placed on the work tray, adjust the leg levelers, first, end-to-end then front to back. The NSF approved leg levelers provide a $\pm 3/4"$ (20mm) adjustment.

5.2.3 Bench Installation (BCD-16300)

Place the cabinet on the bench with approximately a 2" (51mm) overhang clearance for installation of the drain valve. If the drain valve is not desired, cap with 3/8" NPT fitting and place the cabinet in its desired location and using RTV caulk, seal all around the base of the cabinet and the bench. This provides a tight seal to prevent bench spills from migrating under the cabinet.

If a drain valve is desired, **(NOTE, CHECK WITH YOUR SAFETY PERSONNEL FOR REGULATORY REQUIREMENTS (i.e. LOCKING TYPE) OF DRAIN VALVE INSTALLATION)** remove the handle from the valve stem to gain clearance for valve body rotation. Add Loctite 242 (furnished) to the threads and rotate valve body until secure, with the valve stem (for handle) on the left side. Re-install handle to valve stem. Adjust the cabinet on bench to provide a 1-1/2" (38mm) overhang and seal the interface of the bench and cabinet, using RTV caulk as above.

5.2.4 Gas Service

Nuair doesn't recommend the use of natural gas within the LFBSC, but if gas service is determined to be necessary for the application, appropriate safety measures must take place. All Nuair LFBSC's have precautionary warning labels that say the following:

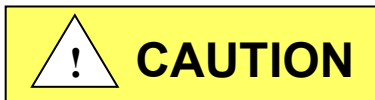

Use of explosive or flammable substances in this cabinet should be evaluated by your appropriate safety personnel.

Once the appropriate safety personnel have made the determination, the application of natural gas must be performed in accordance to national, state and local codes. **IT IS ALSO STRONGLY RECOMMENDED THAT AN EMERGENCY GAS SHUTOFF VALVE BE PLACED JUST OUTSIDE THE LFBSC ON THE GAS SUPPLY LINE.**

All Nuair LFBSC's meet the safety requirements of UL and CSA for Laboratory Equipment. To comply with these safety requirements, Nuair uses only certified gas valves. In addition, if external piping is required, only black pipe is used for this application.

As previously stated Nuair doesn't recommend the use of natural gas within the LFBSC and **ASSUMES NO RESPONSIBILITY FOR ITS USE. USE AT YOUR OWN RISK.** The Bunsen burner flame within the LFBSC not only contributes to heat build-up; is also disrupts the laminar air stream, which must be maintained for maximum efficiency. **IF THE PROCEDURE DEMANDS USE OF A FLAME, A BUNSEN BURNER WITH ON DEMAND IGNITION IS STRONGLY RECOMMENDED. DO NOT USE CONSTANT FLAME GAS BURNERS.** During use, the Bunsen burner should be placed to the rear of the workspace where resulting air turbulence will have a minimal effect.

5.2.5 Plumbing Services

Service ball valves with the type of service specified by the removable button on the handle are located in the work zone. The service ball valves are not recommended for pressure over 75 p.s.i. (5.2 BAR). Reducing valves should be installed external to the cabinet if necessary. Service ball valves should never be used for flammable gasses or oxygen service. A special needle valve for oxygen service or certified valve is required and available upon request.

External connection is to 3/8 inch NPT coupling in the inner sidewalls. Connection to plant utilities should be made with proper materials for the individual service and according to National and/or Local codes. Observe all labels pertaining to the type of service and operating pressure.

Remote controlled needle-valve plumbing fixtures can be optionally provided within the interior sidewalls. Control handles are located externally on the vertical airfoil. Service outlets within the interior have serrated tapered fittings designed for hose connections with the remote controlled needle valve plumbing fixtures. Nuair provides for rear, bottom, or top connections of plumbing services to plant utilities. Connection from the needle valve assembly to the welded exit coupling is accomplished with the supplied 3/8 inch soft copper tubing as standard (alternative materials to meet local codes are available upon request). The needle valves are not recommended for working pressure in excess of 125 p.s.i. (8.6 BAR).

5.2.6 Electrical Services

The NU-565 series Biosafety Fume Hood/Cabinets may be "hardwired" (optional) or plugged into an outlet with protective earthing connection with the standard power cord. The cabinet requires 115VAC, 60Hz single phase (correct rating varies per cabinet size, reference Electrical/Environmental Requirements). It is recommended that power to the cabinet, whether hardwired or plug connected, be on its own branch circuit, protected with a circuit breaker at the distribution panel near the cabinet. **A surge protector is strongly recommended** if you are experiencing power related faults.

PLEASE NOTE THIS CABINET CONTAINS ELECTRONIC BALLASTS FOR THE FLUORESCENT LIGHTING. ELECTRONIC BALLASTS OPERATE WITH HIGH INRUSH CURRENT. IT IS NOT RECOMMENDED TO USE THIS PRODUCT WITH GROUND FAULT CIRCUIT INTERRUPTERS (GFCI'S) BECAUSE THE BALLASTS MAY CAUSE THE GFCI TO TRIP.

If a "hardwired" (conduit) connection is desired, an electrical junction box is provided on the top of the workstation with a removable cover. All wiring connections to the junction box should be done according to the National Electrical Code as well as stated items below per the UL 61010-1 and/or local codes by a qualified electrician.

Items required for the "hardwired" connection:

- 1) A switch or circuit breaker must be included in the installation;
- 2) It must be suitably location and easily reached;
- 3) It must be marked as the disconnecting device for the unit.

5.2.7 Exhaust/Supply Duct Installation Guidelines

The exhaust/supply systems must provide conditions similar to that under which the cabinet was certified to meet its stated performance. The following guidelines should be observed when installing exhaust/supply air ductwork for either existing plant exhaust systems, or a new exhaust system.

1. Adequate room make-up air inflow to replace exhausted air. Air diffusion rate is not to exceed velocity of 100 LFPM (.51 m/s) to minimize disruptive air currents. If laboratory is to be pressurized, follow guidelines in ANSI/AIHA Z9.5 Laboratory Ventilation.

Room Make-Up Air Requirements (CFM/CMH) Utilizing Concurrent Balance Values

Model	Room make-up air volume
NU-565-400	815 / 1385
NU-565-600	1275 / 2166

2. Adequate plant exhaust system capability. The exhaust system is usually adequate if it can provide the rated exhaust flow and static pressure.
3. All duct losses must be considered and added to the cabinet loss in selecting the exhaust blower, for a new exhaust system (i.e. duct diameter, length and number of elbows, etc.).
4. Adequate supply air capability (if used). The supply air system is usually adequate if it can provide the rated supply air at 0.0 inches water gauge positive.
5. The supply air must be interlocked with the operation of the cabinet's internal downflow blower in order to prevent downflow air from being forced out of the front of the cabinet when powered off or during night setback conditions. Nuair provides fan relay contacts for this purpose.
6. All ductwork should be securely anchored to the building construction in manner to be free from vibration and swaying under all conditions of operations.
7. Sheet metal gauges and seams should be in accordance with the current edition of the ASHRAE guide. A minimum of 20 gauge for round duct is required to prevent duct collapse due to high static pressure conditions (square duct will require heavier gauge material).
8. All ductwork should be maintained at a negative pressure within the building (i.e. externally located exhaust blower).
9. The exhaust blower and duct work should be a sealed system that can hold 2.0 inches (51mm) w.g. pressure for 30 minutes with no more than a 10% drop in pressure and be properly vented to the atmosphere to disperse exhausted air.
10. A local manual exhaust flow damper (Nuair Model NU-940) should be readily accessible (either directly mounted on the LFBSC exhaust collar or just above the LFBSC) for the maintenance technician/certifier to allow the LFBSC to be sealed for decontamination purposes. If a Constant Air Volume (CAV) valve is located above the LFBSC, any exhaust flow adjustments should be made to the CAV valve leaving the manual exhaust damper in a full open position.
11. It is recommended that the cabinet operation be interlocked with the exhaust blower. Fan relay contacts are provided for this purpose. However, it is also recommended to have a manual exhaust override switch near the cabinet for certification and service. For multi-ganged systems, this switch could be used to interface with a Building Automated System (BAS).
12. It is recommended that when using the NU-951-012 automatic butterfly valve, the system air volume must remain within ten percent of the given nominal setpoint volume to optimize the measurement and control performance.
13. It is not recommended to hard connect (i.e. weld) the exhaust connection to the cabinet. This may damage the exhaust filter and/or the butterfly valve (if present). A silicon sleeve (Nuair Part No. NU-940-001), banded between the cabinet's exhaust duct and the plant exhaust duct is recommended, with no more than a two-inch gap between the ducts, for a 1/8 inch (3mm) thick silicone sleeve. If Nuair damper valves are present, see Drawing BCD-05572 for installation.

THE NUAIRE BIOLOGICAL SAFETY CABINET HAS A DRAIN PAN BELOW THE WORK TRAY DESIGNED TO SUBSTANTIALLY DRAIN SPILLS THAT ACCIDENTALLY OCCUR IN THE WORK ZONE. A 3/8" BALL DRAIN VALVE IS LOCATED ON THE FRONT OF THE CABINET FOR CONVENIENCE. THE CABINET BASE MEETS THE NSF OBJECTIVE WITH THE CAPABILITY OF BEING SEALED TO THE BENCH UPON WHICH IT RESTS.

FIGURE - 1

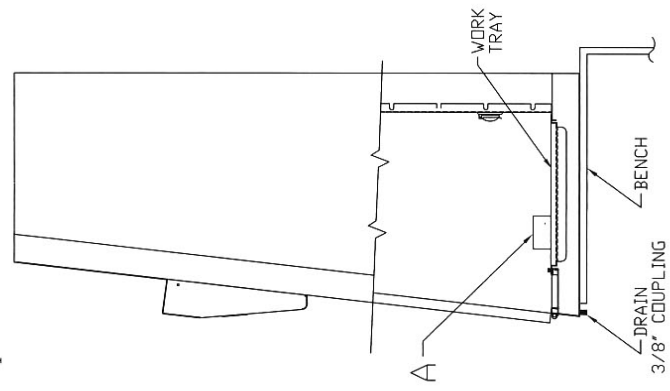

- 1.) PLACE THE CABINET ON A BENCH WITH APPROXIMATELY 2 (51mm) INCHES OVERHANG CLEARANCE FOR INSTALLATION OF DRAIN VALVE.
- 2.) REMOVE CARTON - A AND CONTENTS FROM WORK AREA, AND INSTALL THE DRAIN VALVE AS SHOWN IN FIGURE 2.

REV	ECO	DESCRIPTION	DATE	DRFT	CHKD
B	13327	ADDED NU-550/560/565	4/14/2017	TH	BP

FIGURE - 2

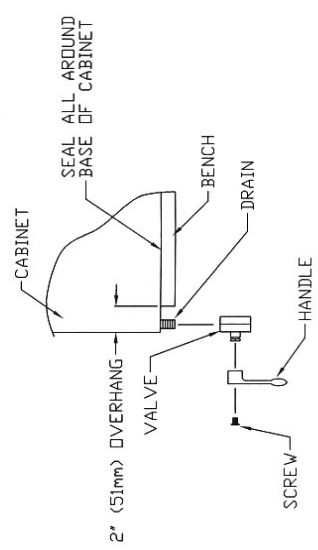

- 3.) REMOVE HANDLE FROM VALVE STEM TO GAIN CLEARANCE FOR VALVE BODY ROTATION FOR INSTALLATION OF DRAIN VALVE.
- 4.) ADD LOCTITE 242 FURNISHED TO THREADS AND ROTATE VALVE BODY UNTIL SECURE WITH VALVE STEM ON LEFT SIDE AS SHOWN.
- 5.) RE-INSTALL HANDLE TO VALVE STEM.
- 6.) ADJUST THE CABINET ON THE BENCH, WITH A 2" (51mm) OVERHANG AND SEAL INTERFACE WITH BENCH TOP, USING RTV SILICON SEALANT.

FIGURE - 3

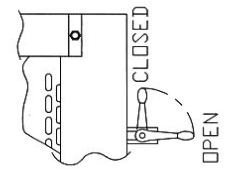

		ORIGINAL
NU-540 / 543 / 545 / 546 / 550 / 560 / 565	DRAIN VALVE INSTALLATION	
DFTM/LS	9/12/13	CHKD/BP
DRAWING NUMBER	BCD-16300	
		B

REV	ECD	DESCRIPTION	DATE	DPTH	CHKD
D	7766	UPDATE TO SILICON MAT'L COMPONENTS	11/12/99	LS	BP

- INSTRUCTIONS:
- 1.) CLEAN INSIDE RING OF BUTTERFLY VALVE ASSEMBLY AND OUTSIDE RING OF CABINET WITH ALCOHOL OR ACETONE.
 - 2.) APPLY 1/4 INCH (6mm) BEAD OF SILICONE (DDV CORNING 732) RTV AROUND INSIDE EDGE OF BUTTERFLY VALVE ASSEMBLY.
 - 3.) PRESS FIT BUTTERFLY VALVE ASSEMBLY ONTO CABINET RING NOTING POSITION OF HANDLE OR ACTUATOR. TAPPING DOWN BUTTERFLY VALVE ASSEMBLY WITH RUBBER Mallet WILL ASSURE A TIGHT FIT. ADDITIONAL USE OF DUCT TAPE MAY BE REQUIRED DEPENDING UPON INSTALLATION.
 - 4.) CONNECT EXISTING DUCTWORK TO BUTTERFLY VALVE USING A SILICONE SLEEVE. WRAP THE SLEEVE AROUND THE VALVE AND DUCT EXTENDING THE SLEEVE A MINIMUM OF 1 in (25mm). OVERLAP THE SLEEVE A MINIMUM OF 1 in (25mm) AND REMOVE REMAINING SLEEVE MATERIAL. GLUE THE OVERLAPPED SEAM WITH SILICON SEALANT PROVIDED, RESULTING IN A GAS-TIGHT SEAL. USING THE BAND CLAMPS, CLAMP SLEEVE INTO PLACE TO ASSURE A TIGHT SEAL.

CAUTION
DO NOT DRILL OR USE MECHANICAL FASTENERS THAT WILL DROP METAL PARTICLES ONTO THE HEPA FILTER JUST BELOW THE ATTACHMENT AREA OR CAUSE CONFLICT WITH OPERATION OF BUTTERFLY VALVE ASSEMBLY.

NOTE
POSITION OF VALVE ASSEMBLY WITH IN BIO-SAFETY LEVEL THREE FACILITIES MAY BE ALTERED TO ACHIEVE MAXIMUM CONTAINMENT FOR THE INDIVIDUAL DESIGN REQUIREMENTS.

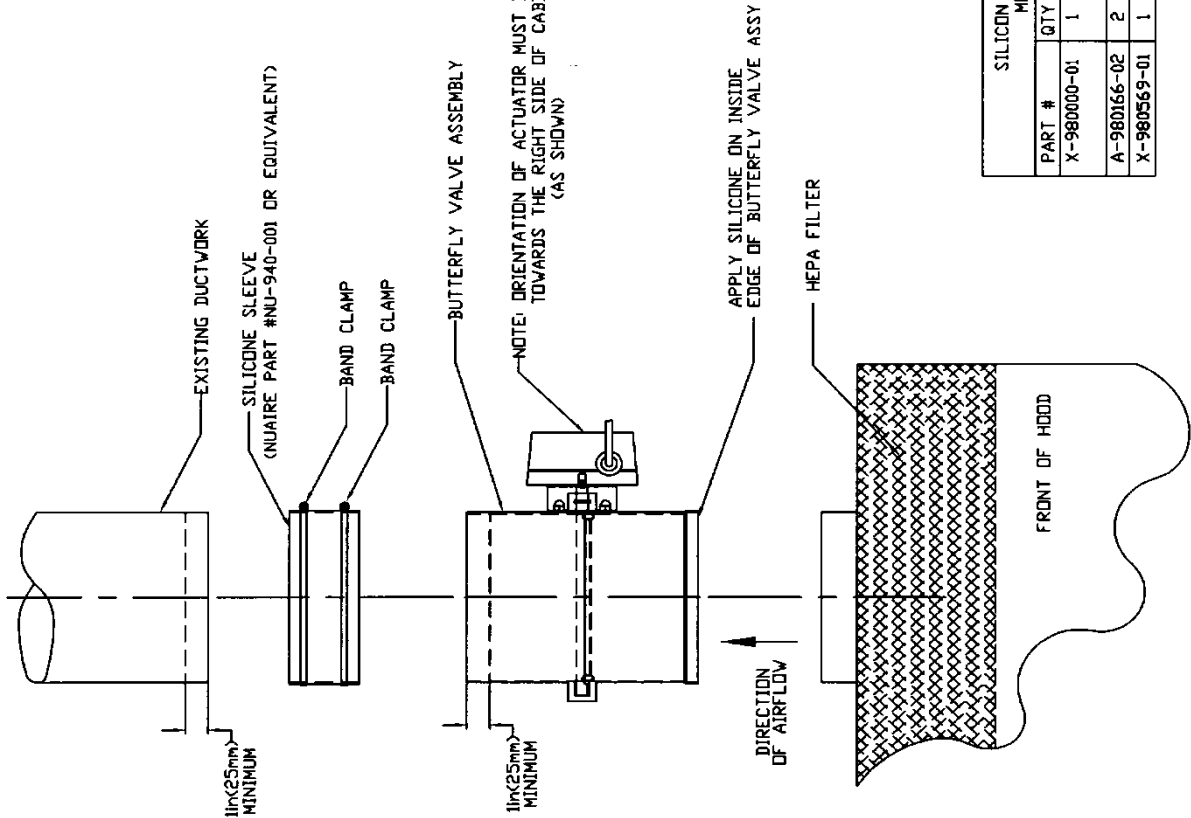

SILICON CONNECTION SLEEVE KIT	
MODEL # NU-940-001	
PART #	QTY
X-980000-01	1
SILICON SLEEVE (6x60 IN)(152x1524mm)	
A-980166-02	2
STAINLESS STEEL BAND CLAMPS	
X-980569-01	1
SILICON SEALANT	

	PROPRIETARY THE INFORMATION CONTAINED HEREIN IS THE EXCLUSIVE PROPERTY OF MVA, INC. AND IS NOT TO BE DIVULGED OR USED IN ANY MANNER WITHOUT THE EXPRESS WRITTEN PERMISSION OF MVA, INC.
	DATE 9/12/95 DPTH TW CHKD LS UNLESS OTHERWISE SPECIFIED IN DRAWING, ALL DIMENSIONS ARE IN INCHES. -TOLERANCES- DECIMALS .002 ANGLES .42
TITLE	RECOMMENDED GAS-TIGHT BUTTERFLY VALVE INSTALLATION
MATERIAL	AS NOTED
NUMBER	BCD-05572
DO NOT SCALE DRAWING SHEET 1 OF 1	

5.2.8 Final Assembly

Remove the protective cardboard cover over the supply and exhaust connections on top of the cabinet. The exterior surface and viewing glass are easily cleaned with any mild household detergent cleaner using a soft cloth. Harsh chemicals, solvent-type cleaners and abrasive cleaners should not be used.

Do not attempt to clean the HEPA filter media. Cabinet interior walls or work surface are easily cleaned with any mild household detergent cleaner using a soft cloth. Turn the cabinet on and let it operate for 60 minutes before using it as a LFBSC.

5.3 Exhaust/Supply Air Checks

 **NOTE: THE INTERNAL SUPPLY BLOWER IS INTERLOCKED WITH THE EXHAUST SENSOR, TO PREVENT OPERATION UNLESS ADEQUATE EXHAUST FLOW IS PRESENT.**

5.3.1 Exhaust Volume / Inflow Velocity

The exhaust volume and corresponding inflow velocity is displayed on the front panel. Preset lower and upper alarm limits are factory set but can be field verified at any time. To ensure that adequate exhaust is available for a dirty exhaust HEPA filter, condition, the nominal exhaust readings should be attainable with the butterfly valve or damper set at 60 percent open, with all other dampers in the system (duct) open.

5.3.2 Supply Velocity

The supply volume is controlled by the BSCC airflow control system. The BSCC system uses a dual thermistor airflow sensor in the downflow air stream to monitor and control airflow to setpoint. The control system automatically compensates for filter loading, voltage variances and other environmental effects. However, excessive variances caused by remote butterfly valves or dampers, insufficient supply air and dirty prefilters may cause an airflow alarm condition to occur.

 **NOTE: THE SUPPLY AIR, IF INTEGRALLY DESIGNED, MUST BE INTERLOCKED WITH THE INTERNAL FAN RELAY TO ASSURE PROPER OPERATION.**

5.4 Certification Testing Methods and Equipment

After installation and prior to use, Nuaire recommends that the cabinet be certified or commissioned to factory standards. As a part of certification, the certifier should go through the following initial checklist to assure all aspects of the LFBSC installation are complete and ready for certification.

- Review product installation
 - Exhaust connection
 - Damper valve installed correctly with label toward front
 - LFBSC base stand level
- Verify airflow sensor shroud is in place
 - Downflow
- Verify configuration type selection for specific model * (see section 7.5.2)
- Verify setpoints and alarm limits for specific model * (see section 7.5.2)
- Perform BCS certification
 - At a minimum, the following tests should be performed:
 - HEPA filter leak test
 - Downflow velocity test
 - Inflow velocity test
 - Airflow smoke patterns
 - Site installation assessment tests
- Perform Site Assessment Tests
 - The NU-565 requires verification of the supply fan interlock and back-up pressure switch operation utilizing independent exhaust volume measurement instrument (DIM). Per NSF/ANSI 49, a 20% loss of exhaust volume must produce an airflow alarm within 15 seconds.

The testing methods and equipment required are specified on the factory inspection report included with this manual. (See insert in back cover)

 **NOTE: IT IS RECOMMENDED THAT THESE TESTS BE PERFORMED BY A QUALIFIED TECHNICIAN WHO IS FAMILIAR WITH THE METHODS AND PROCEDURES FOR CERTIFYING BIOSAFETY FUME HOOD/CABINETS (SEE INSERT)**

 **NOTE: AFTER THE INITIAL CERTIFICATION, NUAIRE RECOMMENDS THAT THE CABINET BE RECERTIFIED (AT A MINIMUM) ON AN ANNUAL BASIS AND AFTER EVERY FILTER CHANGE OR MAINTENANCE ACTION OR ANY TIME THE OPERATOR FEELS IT IS NECESSARY.**

Note that the LABGARD® ES cabinets, filters, and seals provide premium performance. Quality Control in both design and manufacturing assure superior reliability. However, protection to both product and operator is so vital that certification to the performance requirements should be accomplished as stated to ensure Biosafety established by the factory standards.

* If the specific model is a special product with non-standard setpoints and alarm limits, the new values will be located on the factory Inspection Report.

**LabGard® ES Energy Saver Class II, Type B2 Laminar Flow Biosafety Fume Hood/Cabinet
Models NU-565-400/600**

Catalog Number	Catalog		Number	
	NU-565-400 Nominal 4 foot (1.2m)		NU-565-600 Nominal 6 foot (1.8m)	
Performance Specifications 1. Personal Protection 2. Product Protection	NSF/ANSI 49 UL 1805	NSF/ANSI 49 UL 1805	NSF/ANSI 49 UL 1805	NSF/ANSI 49 UL 1805
NSF/ANSI 49	Class II, Type B2	Class II, Type B2	Class II, Type B2	Class II, Type B2
Style of Cabinet	Bench Top/Console w/Base Stand/ Storage Cabinet	Bench Top/Console w/Base Stand/ Storage Cabinet	Bench Top/Console w/Base Stand/ Storage Cabinet	Bench Top/Console w/Base Stand/ Storage Cabinet
Cabinet Construction	All welded stainless steel 16/18GA, Type 304 pressure tight design	All welded stainless steel 16/18GA, Type 304 pressure tight design	All welded stainless steel 16/18GA, Type 304 pressure tight design	All welded stainless steel 16/18GA, Type 304 pressure tight design
Diffuser for Air Supply (Metal)	Non-Flammable	Non-Flammable	Non-Flammable	Non-Flammable
HEPA Filter Seal Type: Supply Filter-99.99% Eff. on 0.3 Microns Exhaust Filter-99.99% Eff. on 0.3 Microns (UL 586)	HEPEX Seal Neoprene, Spring loaded	HEPEX Seal Neoprene, Spring loaded	HEPEX Seal Neoprene, Spring loaded	HEPEX Seal Neoprene, Spring loaded
Fumigation per NIH/NSF Procedure	Yes	Yes	Yes	Yes
Standard Services: Service Coupling (3/8 inch NPT) Remote controlled service valves (3/8 inch NPT) Duplex Outlet	Two: Left middle, bottom Two: Right bottom, middle sidewall One, Left Front Faring	Two: Left middle, bottom One, Right bottom, middle sidewall One, Left Front Faring	Two: Left middle, bottom One, Right bottom, middle sidewall One, Left Front Faring	Two: Left middle, bottom One, Right bottom, middle sidewall One, Left Front Faring
Optional Services: Remote Controlled Valves	Up to 3 ea. Sidewall	Up to 3 ea. Sidewall	Up to 3 ea. Sidewall	Up to 3 ea. Sidewall
Cabinet Size Inches (mm): Height (Fully Assembled) (Incl. Exh Filter Fastener) Height (Minimum for Transport) Width Depth (with Armrest removed)	62 (1575) 62 (1575) 53 5/8 (1362) 32 3/8 (823)	62 (1575) 62 (1575) 53 5/8 (1362) 32 3/8 (823)	62 (1575) 62 (1575) 77 5/8 (1972) 32 3/8 (823)	62 (1575) 62 (1575) 77 5/8 (1972) 32 3/8 (823)
Work Access Opening Inches (mm): Standard Opening Height Standard Inflow Velocity	8 (203) 105 FPM (.53 m/s)	8 (203) 105 FPM (.53 m/s)	8 (203) 105 FPM (.53 m/s)	8 (203) 105 FPM (.53 m/s)
Work Zone Inches (mm): Height Width Depth measured at 8 inches (203mm)	25 3/16 (640) 46 3/8 (1178) 26 (660)	25 3/16 (640) 46 3/8 (1178) 26 (660)	25 3/16 (640) 70 3/8 (1788) 26 (660)	25 3/16 (640) 70 3/8 (1788) 26 (660)
Viewing Window Inches (mm): Standard is Tempered Sliding Glass Hinged Tempered Glass (optional)	0.375 (10 mm) Closed 18 1/2 (470) Open 8 (203) Access Opening	0.375 (10 mm) Closed 18 1/2 (470) Open 8 (203) Access Opening	0.375 (10 mm) Closed 18 1/2 (470) Open 8 (203) Access Opening	0.375 (10 mm) Closed 18 1/2 (470) Open 8 (203) Access Opening
Certification Exhaust Value CFM/CMH Concurrent Balance Value CFM/CMH +	740/1257 815/1385	740/1257 815/1385	1122/1906 1275/2166	1122/1906 1275/2166
Plant Duct Static Pressure Eng./Metric	1.7 w.g./43mm w.g.	1.7 w.g./43mm w.g.	1.8 w.g./46mm w.g.	1.8 w.g./46mm w.g.
Heat Rejected, BTU, Per Hour	474	474	584	584
Electrical: 115V Volts, AC (Hz) ++Amps: Blower/Lights Amps: Outlet Rated Amps: 12 ft. Power Cord (one)	U.L./UL-C, US Listed, Classified 115, 60 2.1 3 8 14 GA - 3 Wire, 15A	U.L./UL-C, US Listed, Classified 115, 60 2.1 3 8 14 GA - 3 Wire, 15A	U.L./UL-C, US Listed, Classified 115, 60 2.6 3 10 14 GA-3 Wire, 15A	U.L./UL-C, US Listed, Classified 115, 60 2.6 3 10 14 GA-3 Wire, 15A
Crated Shipping Weight: Net Weight	540 lbs. /245 kg. 490 lbs. /222 kg.	540 lbs. /245 kg. 490 lbs. /222 kg.	730 lbs. /331 kg. 680 lbs. /308 kg.	730 lbs. /331 kg. 680 lbs. /308 kg.

**Remote controlled valve handles project through front fairing. Decorative side panels are available to cover plumbing.

+Concurrent Balance Value shall be used for design and balance exhaust/supply HVAC requirements. Values provided are nominal. Design tolerances should be added for measurement and system differences.

++ Based on cabinet with new filters running at 115 VAC.

6.0 Operating the NU-565

6.1 Biosafety Fume Hood/Cabinet Control

6.1.1 Overview

The Biosafety Fume Hood/Cabinet Control (BSCC) system is designed to service the control requirements of the NU-565 Biosafety Fume Hood/Cabinet. The control system is a self-contained microprocessor driven module that will perform the following functions:

- Easy use interface via **TOUCHLINK** color LCD.
- Control blower DC ECM Motor via solid-state DC Motor Controller that provides automatic compensation (constant volume control) for both filter loading and line voltage variances.
- Intelliflow™ - Fast, accurate, reliable dual thermistor, airflow sensors and digital differential velocity pressure flow grid powered by TSI to control and monitor cabinet airflows to setpoints.
- Control lights via solid state switch.
- Control outlets via solid state switch.
- Display date/time w/battery backup.
- Display blower and optional UV light run timers.
- Display alarm setpoints high/low for error conditions (downflow/inflow).
- Display complete calibration, option menu and diagnostic functions.

The NU-565 BSCC system offers the latest digital microprocessor design technology for improved cabinet performance and safety. The control system uses a digital dual thermistor airflow sensor in the downflow stream to monitor and control airflow to setpoints. The control system automatically compensates for filter loading, voltage variances and other environmental effects. A digital differential velocity pressure glow grid in the exhaust airstream monitors for exhaust volume and subsequent inflow velocity. Downflow velocity, exhaust volume and inflow velocity are displayed on the **TOUCHLINK** LCD screen. The control system also monitors the sliding window position with a micro switch for both window height and window closed positions.

The control system through the use of the front panel controls the on/off function of the fluorescent and ultraviolet lights (optional), outlets and DC ECM motor/blower. The control system also allows contact closure outputs for interaction with HVAC systems to optimize environmental performance.

User interface to the BSCC system is accomplished via the **TOUCHLINK** LCD. Basic use of the LFBSC is accomplished via the icons located along the top of the screen as shown below. Touch an icon to turn on/off functions as indicated. Each icon will illuminate with color to indicate when the function is turned on. The menu icon will always prompt a menu screen to display. Selecting a menu item will continue the prompts until the desired parameter is achieved. To return to the main menu, press the MENU icon repeatedly to reverse out of the parameter menus.

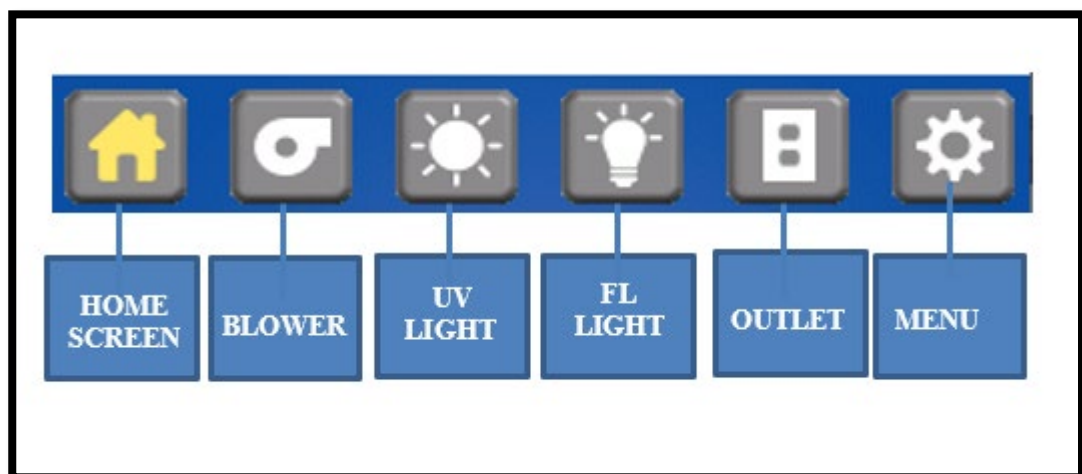

6.1.2 Standby Mode

When the BSC is not in use, the **TOUCHLINK** LCD screen will display Standby, the icons along the top and the time and date at the bottom as shown below. Any of the function icons, except the blower, that initiates Run Mode, may be turned on and off in standby mode. The menu icon may also be accessed for additional user menus.

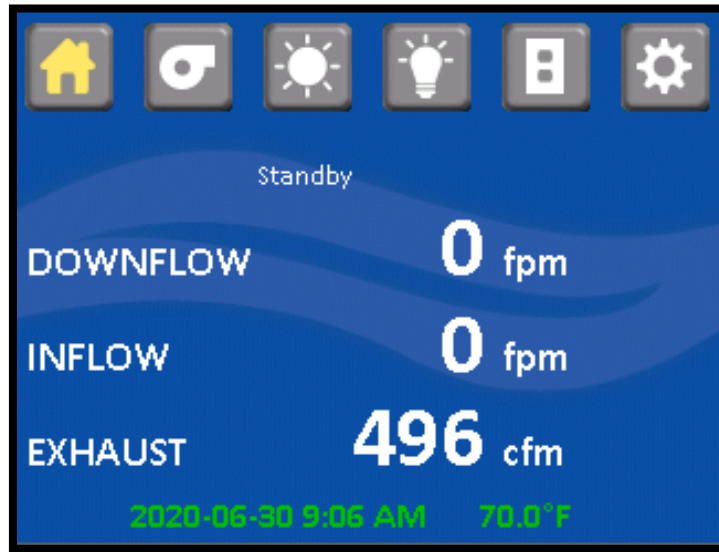

6.1.3 Run Mode

Anytime the blower icon is selected the Run Mode screen will appear. The Run Mode screen will display set points and the countdown of a 2 minute warm-up period. During the warm-up period the aseptic cleaning process may begin. If the sliding window is raised an audible and visual alarm will occur, but may be silenced by pressing the alarm silence icon that appears. Once the warm-up period is complete, airflow readings and all system functions will operate and be displayed.



6.1.4 Standby/Run Mode Alarms

If present, standby/run mode alarms will be both visual and audible, the Red LED oval under the TOUCHLINK LCD display will turn on, and the TOUCHLINK LCD screen will also display a description of the alarm along with alarm silence icon. Audible alarms can be silenced or will produce an alarm tone for 10 seconds, then into a ring back cycle of once every 2 seconds. Pressing the alarm silence icon will silence the audible alarm for 15 minutes, then into a ring back cycle at of once every 2 seconds.

Alarm Types

The middle of the display just below the icons is the message area that will indicate alarms, errors or other notable conditions. Since the message area is limited to one line of text, only the highest priority message will be indicated. However, for alarm conditions, also displayed is a caution symbol and pressing it will display all present alarm conditions. The list below represents the highest to lowest priority.

- Runtime Failure
- Power Loss Alert
- Downflow Sensor Error
- Inflow Sensor Error
- Exhaust Sensor Error
- Downflow Sensor Communication
- Inflow Sensor Communication
- Exhaust Sensor Communication
- Downflow Low Limit
- Downflow High Limit
- Inflow Low Limit
- Inflow High Limit
- Exhaust Low Limit
- Exhaust High Limit
- Cabinet Pressure Low
- Window High
- Window Low
- Replace Filter
- Replace UV Lamp
- Recertification Past Due
- Recertification Due In (x) Week(s)

6.1.5 Menu Icon

The menu icon, when pressed will provide a list of menu items for various TouchLink functions.

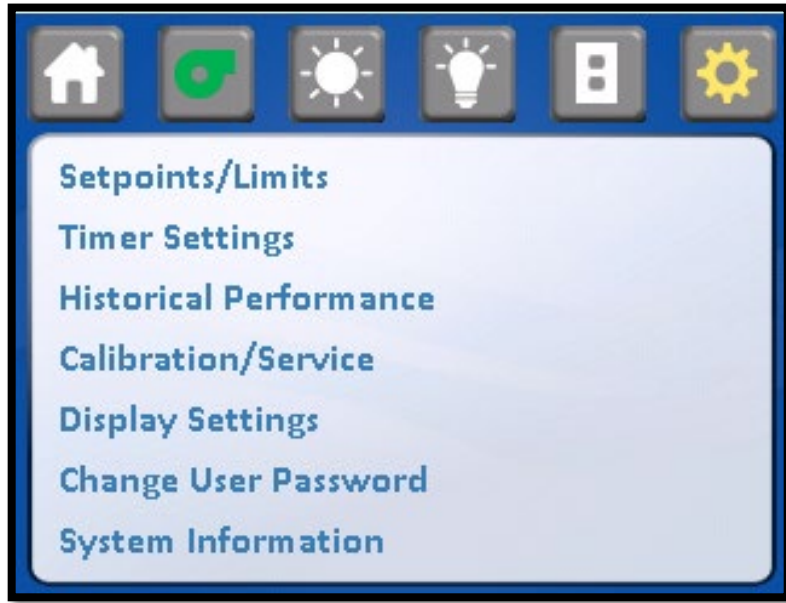

6.1.5.1 Setpoint / Limits:

This menu screen will indicate the Biosafety Fume Hood/Cabinet airflow control setpoints, Access is restricted to service personnel requiring a service password to change values.

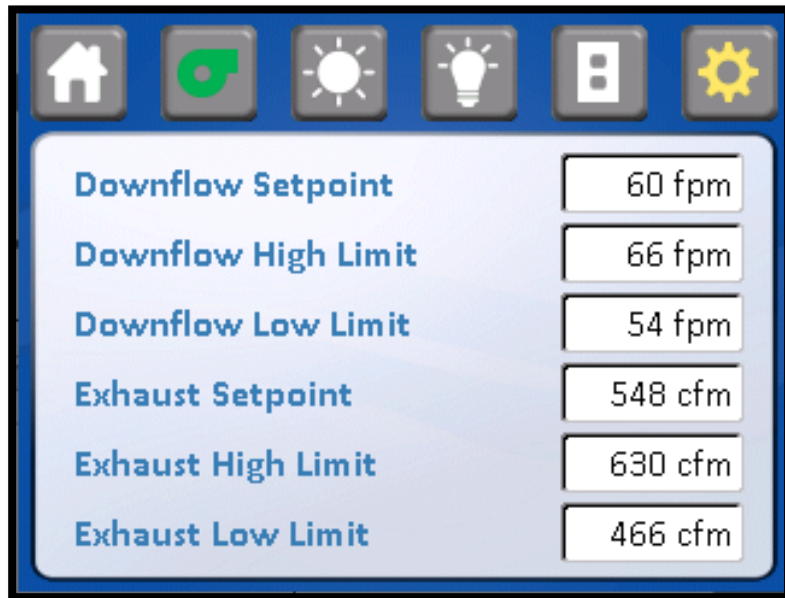

6.1.5.2 Timer Settings:

When pressed timer setting text will provide a list of time functions available for use below is a description of each timer function.



Timer Functions

- **Purge Timer:** This timer controls how long the blower will run to purge the cabinet after the blower icon has been pressed to turn OFF the blower.

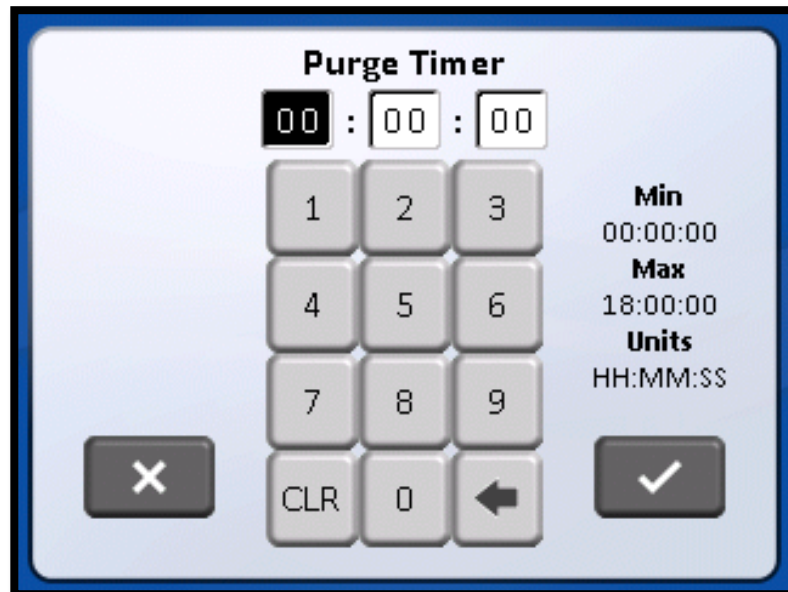

Outlet Timer: This timer controls how long the outlet remains on after the outlet icon has been: pressed to turn on the outlet. If timer is zero, the outlet will stay on until turned OFF.

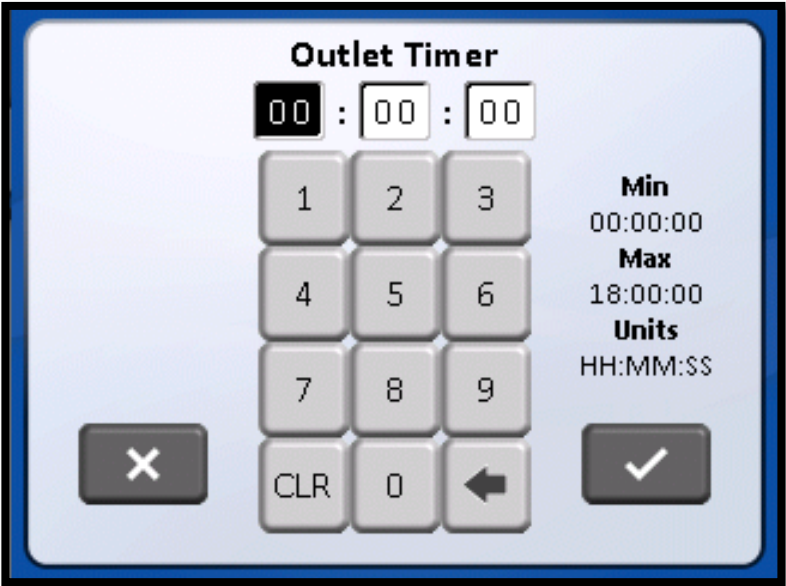

- **UV Light Timer:** This timer controls how long the UV light will remain on after the UV light icon has been pressed to turn on the UV light. If timer is zero, UV light will stay on until manually turned OFF or window is opened breaking the safety interlock

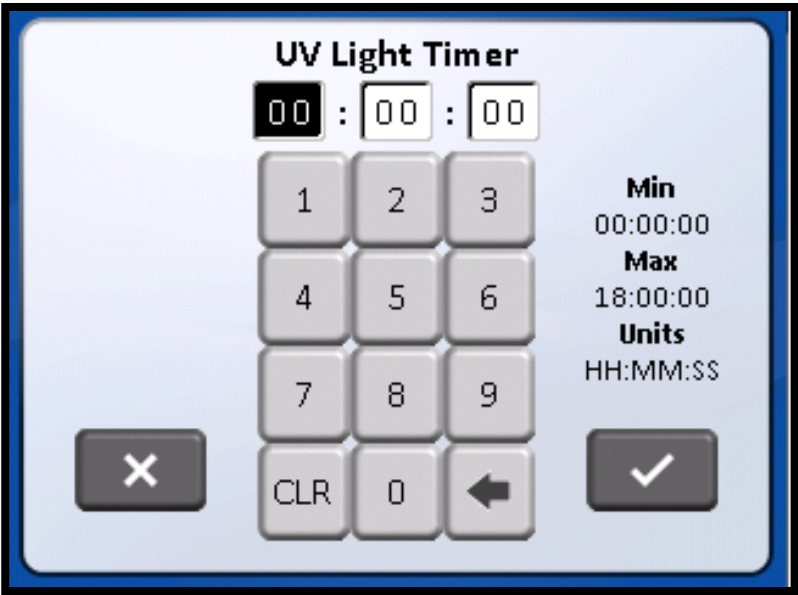

- **Auto Run Timers:** This timer provides the ability to program on a daily basis the start and stop time of the cabinet. To start and stop the cabinets menus that both the blower and LED lights will automatically turn on and off together on a programmed schedule. Once into the auto timer menu, select the desired day for the auto timer to function. If multiple days are desired, each day will be required to be set individually.

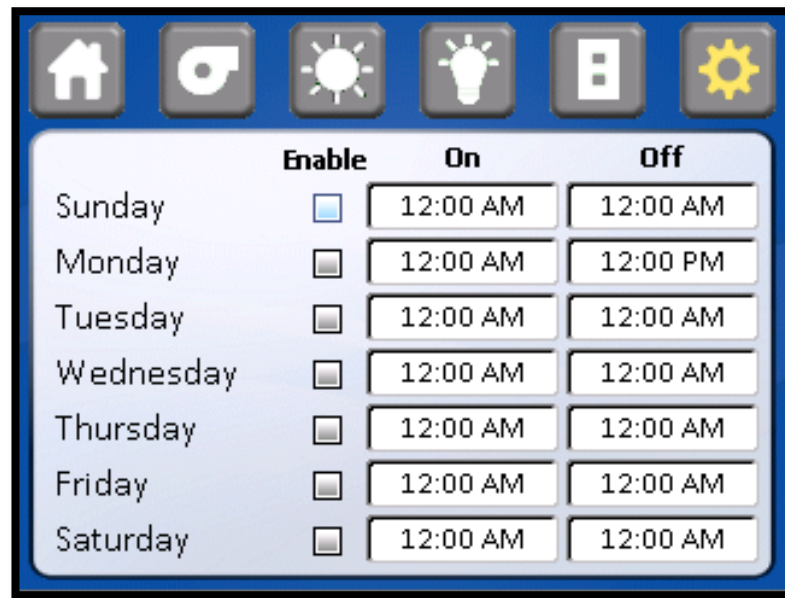

Once into the selected day, press on window to enter the on/off times. Use the keypad to enter hours or minutes. Press menu icon SAVE after each time entry. Repeat auto timer function for each day as desired.

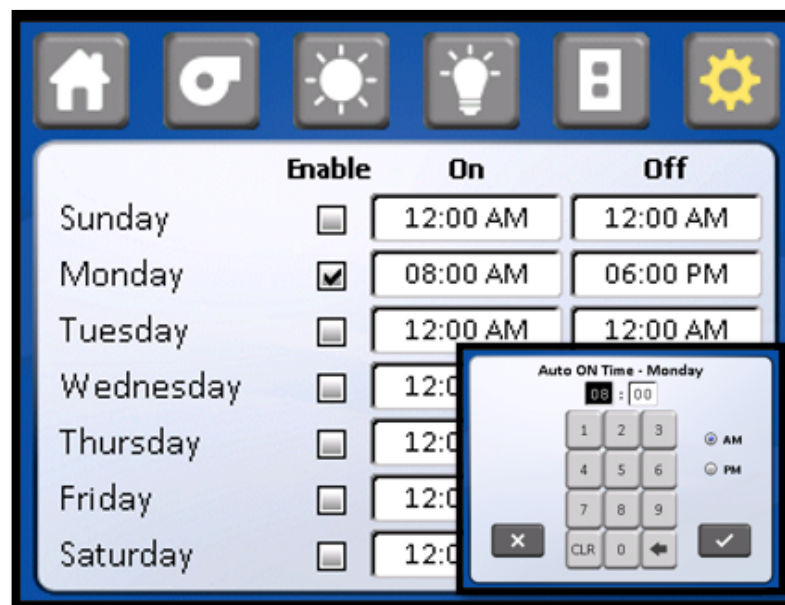

6.1.5.3 Historical Performance:

When press a historical performance text, the system displays downflow and inflow history



- **Downflow History:** press downflow history, the system displays the week log data in graphical form of downflow versus days.

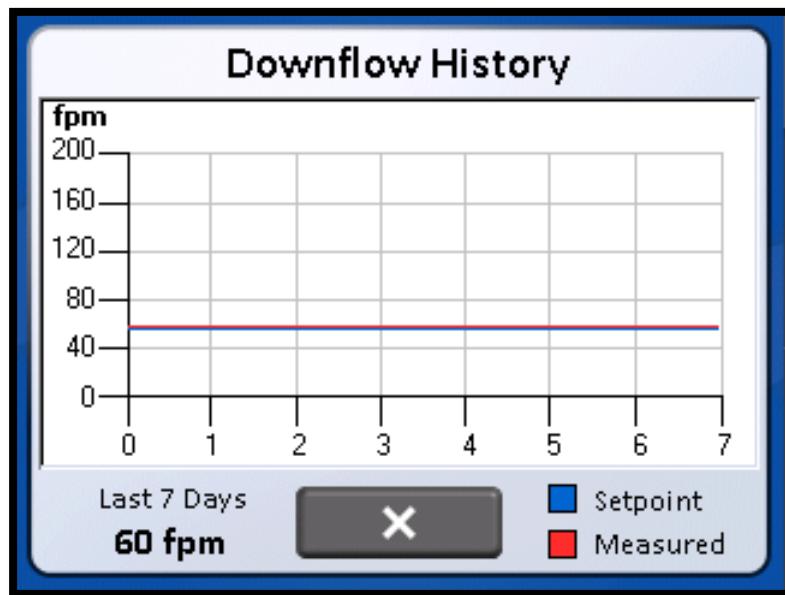

- **Inflow History:** press downflow history, the system displays the week log data in graphical form of Inflow versus days

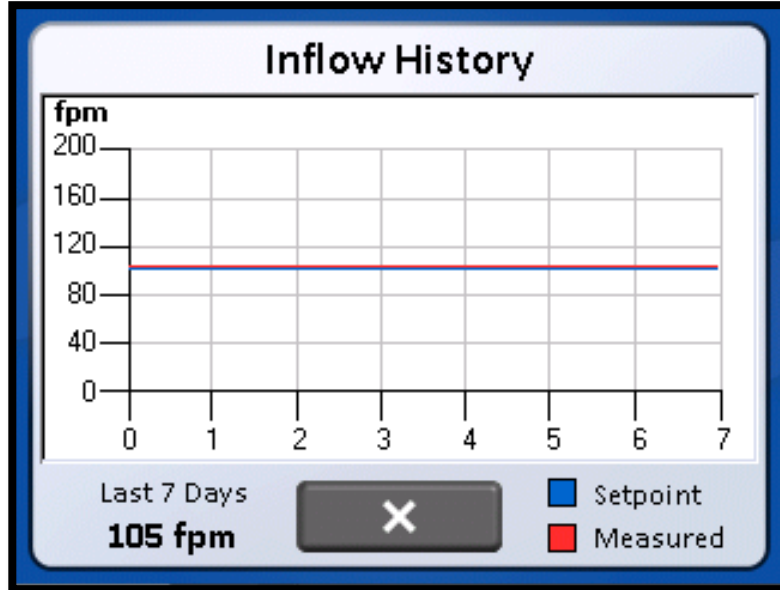

- **Exhaust History:** press Exhaust history, the system displays the week log data in graphical form of exhaust versus days

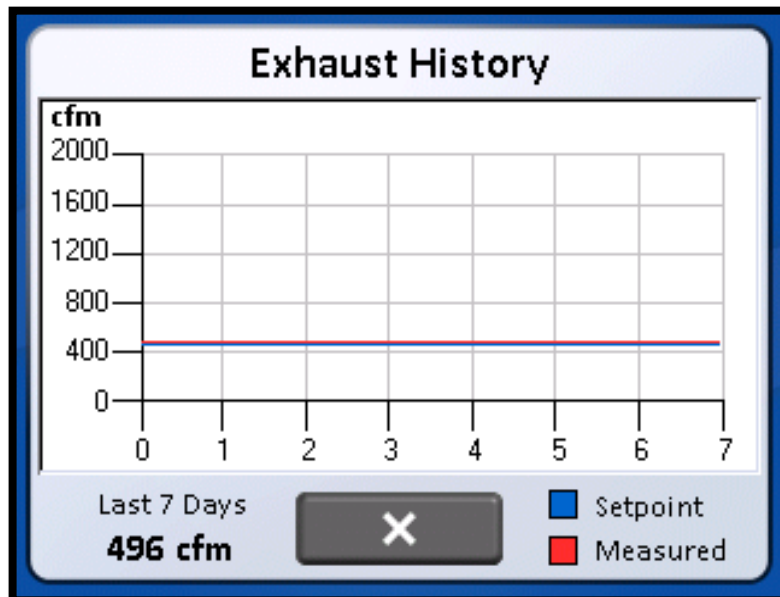

6.1.5.4 Calibration/Service

A password protected area used by certification or service personnel to set up and calibrate the cabinet for certification or commissioning.



6.1.5.5 Display Setting

This menu item provides the ability to alter LCD screen display background contrast and audible touch screen, the strings on this screen will be translated to the language configured on the unit

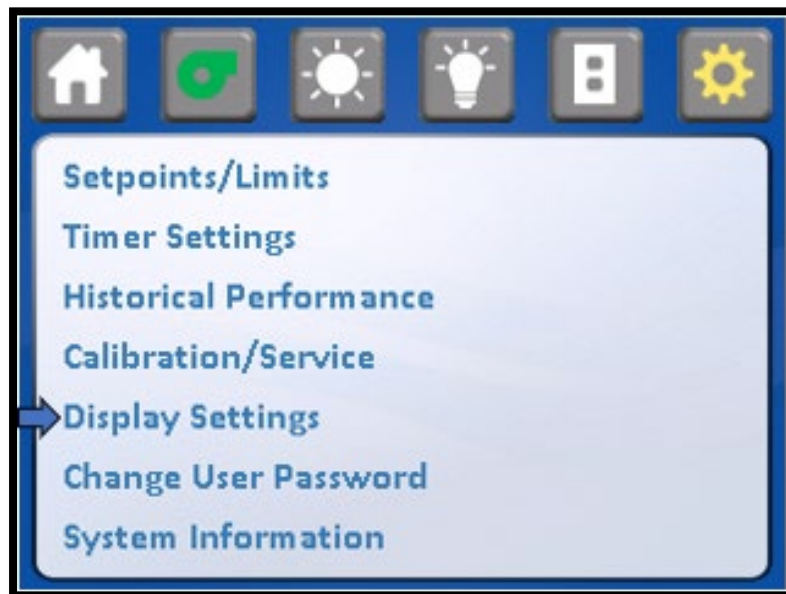

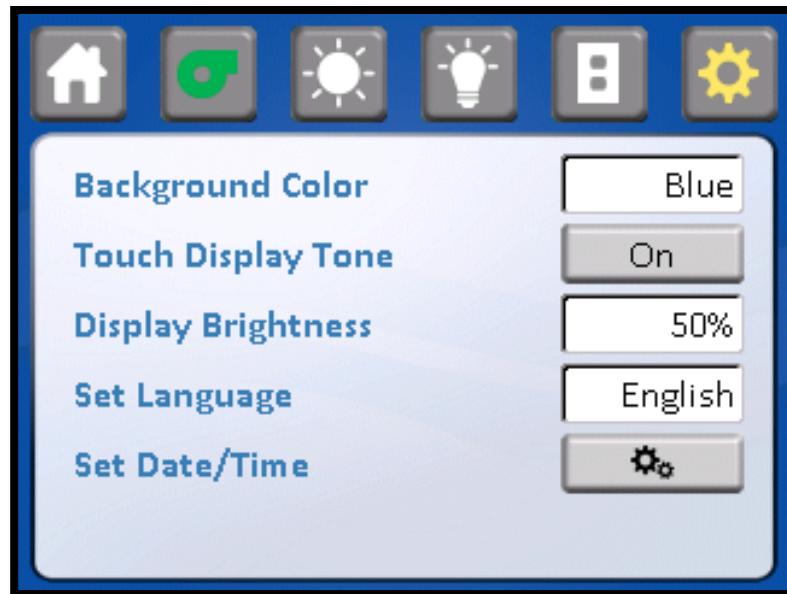

This menu item provides the ability to alter display features and set date/time. Display Background colors of White, Green, Blue and Gray can be selected. Touch display tone audible feedback can turn on/off. Display brightness can be adjusted. Languages may be selected of English, Spanish, French and German

- **Time/Date:** This menu item provides the ability to set the time and date displayed on the LCD screen. Time displayed is real time and will not automatically adjust for day light saving time.

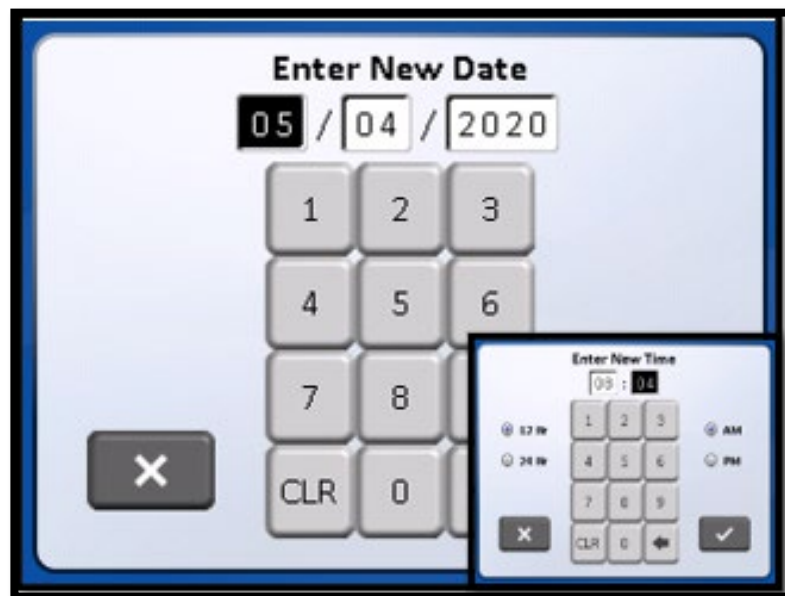

6.1.5.6 Change User Password:

This menu item provides the ability to change the user password from the default value of 1234.

- Set Password: Enter Old Password

Current Password

XXXX

1 2 3

4 5 6

7 8 9

CLR 0 ←

X ✓

- Set New Password

Create Password

Enter a new 4 digit password.

XXXX

1 2 3

4 5 6

7 8 9

CLR 0 ←

X ✓

- Retype New Password



6.1.5.7 System Information

This menu item provides the cabinet model number, serial number, and software revision.

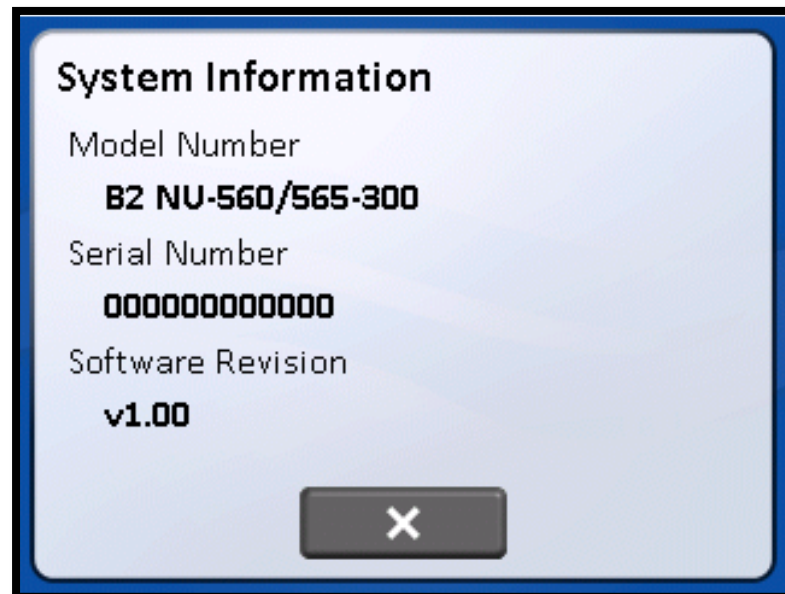

6.1.6 Night Setback (Optional)

The optional night setback feature is used to reduce the exhaust air volume during non-usage periods resulting in conditioned air energy savings. For the night setback to operate, a control valve must be installed (i.e. NU-951-012 motorized air tight butterfly valve) to provide the means for reduction of exhaust airflow.

The night setback is initiated by either closing the contacts on the main control board or enabling the night setback icon on the display. If both are used, the contacts on the main control board have priority over the display icon. Once the contact is closed or icon is pressed the internal blower and fluorescent lights will be turned off and remain inoperable. The exhaust valve will be closed to a percentage of the original setpoint typically to maintain a minimum of 100 fpm (.51 m/s) and the display will indicate night setback active. The sliding window can be closed and the UV light turned on if installed.



NOTE: If night setback exhaust airflow is reduced by the Building Automation System (BAS) and not by the Nuair Model NU-951-012 valve, it would still be recommended to use the contacts on the main control board to initiate the night setback option to display night setback active, inhibit exhaust alarms, light and internal blower.

6.1.7 Remote Override (Optional)

The optional remote override feature is used to remotely control the operation of the cabinet. A typical application would be in a Bio Safety Level three facility that had a room exhaust system failure.

The failure mode could signal the remote override contacts to close and not allow any usage of the cabinet. Once the remote override contacts are closed, the internal blower and fluorescent lights will be turned off and remain inoperable. If an exhaust motorized airtight butterfly valve (NU-951-012) is present the valve will close to seal or optionally fully open the exhaust system.

The display will indicate "Remote Override ". Once the remote override contacts are broken, normal operation will resume.

6.2 Operating Guidelines

The intent herein is to present general operational guidelines that will aid in the use of the Laminar Flow Biosafety Fume Hood/Cabinet (LFBSC) to control airborne contaminants of low to moderate risk as stated in Technical Report No. FPS 5650000001 prepared by Dow Chemical U.S.A. for the National Cancer Institute, May 1, 1972.

Procedure protocols defined in terms of the barrier or control concepts unique to LFBSC must be developed in order to obtain a maximum potential for safety and protection. The pre-planning necessary to develop these protocols is based on several fundamental considerations, each of which will contribute to optimum benefits from the equipment:

- a. Know your "Safe Work Area"
- b. Minimize disruption of "air curtain"
- c. Minimize room activity
- d. Utilize unidirectional airflow
- e. Employ aseptic techniques

6.2.1 Know Your "Safe Working Area"

The LFBSC safe working area is basically the worktray or depressed area. All work should be performed on or above the worktray. The area on or above the front grill is a non-safe working area.

 **NOTE:** It is important to maintain an air gap on both sides of the worktray before fastening in place. The work tray as being part of the cabinet has been designed to load up to 100 lbs. (45.4 kg.) of work materials. Any additional loading should be evaluated by appropriate safety personnel.

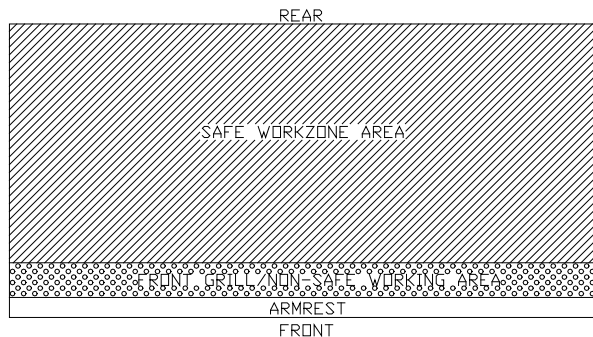

6.2.2 Minimize Penetration of "Air Curtain"

The minimum number of items necessary should be placed into the cabinet to prevent overloading, but the work should also be planned to minimize the number of times an operator's hands and arms must enter and leave the air curtain at the open face. The ideal situation is to have everything needed for the complete procedure placed in the hood before starting, so that nothing need pass in or out through the air barrier at the face until the procedure is completed. This is especially important in working with moderate risk agents.

Unnecessary rising of the hands inside the cabinet above the level of the work opening should be avoided. This presents an inclined plane from hands to elbows along which the downflow of air may run to, and possibly out, the open face.

 **NOTE:** When working with agents of lower risk, it is not as important for all materials to be placed in the cabinet before starting, or for the procedure to be completely finished before materials are removed. Also, the time period for a cabinet may be continued over a more extended period during which entries and withdrawals from the cabinet may be made.

6.2.3 Minimize Room Activity

Activity in the room itself should be held to a minimum. Unnecessary activity may create disruptive air currents as well as interfere with the work of the operator. A person walking past the front of a cabinet can cause draft velocities up to 175 fpm (.89 m/s), which are sufficient to disrupt the air balance of the laminar flow cabinet.

6.2.4 Utilize Unidirectional Airflow

The operator must keep two important facts in mind: (1) The air as supplied to the work area through filters from the top, is contaminant free and (2) Airborne contamination generated in the work area is controlled by the unidirectional flow of parallel air streams in a top-to-bottom direction.

A solid object placed in a laminar air stream will disrupt the parallel flow and consequently, the capability of controlling lateral movement of airborne particulates. A cone of turbulence extends below the object and laminarity of the air stream is not regained until a point is reached downstream, approximately equal to three to six times the diameter of the object. Within the parameters of this cone, particles may be carried laterally by multidirectional eddy currents.

Transfer of viable materials and manipulations, which may generate aerosols, should not be performed above sterile or uninoculated materials. Items should be localized on the work surface in "clean" and "dirty" groups.

6.2.5 Employ Aseptic Technique

The operator must not assume an attitude of "let the cabinet do it" when performing procedures within a LFBSC. Properly balanced and properly used cabinets will do an excellent job of controlling airborne contamination and containing viable agents, but the cabinet will not eliminate contact transmission of contamination. Normal laboratory contamination control procedures and basic aseptic techniques are necessary to obtain maximum benefit from the cabinet. For examples, open bottle, tube or flask mounts should be kept as parallel as possible to the downflow to minimize capture of chance particulates. This precaution is merely an extension of good aseptic technique as practiced on open bench tops. The good laboratory practices designed to minimize creation and/or release of aerosols to the environment should not be discontinued.

Items of equipment in direct contact with the etiologic agent must remain in the cabinet until enclosed or until surface-decontaminated. Trays of discard pipettes must be covered before removal from the cabinet (aluminum foil may substitute for fabricated covers).

If an accident occurs which spills or splatters suspensions of etiologic agent around the work area, all surfaces and items in the cabinet must be surface-decontaminated before being removed.

Applying a burner flame to flask and tube necks when mating surfaces of sterile assemblies is a conventional method of minimizing chance contamination. However, the efficiency of this operation is usually related to the removal of airborne contamination occurring while the item is uncovered. If the manipulation is carried out in an environment free of airborne particulates, then the need for the flaming operation is essentially removed. This is one of the additional advantages of the LFBSC - use of the gas burner is seldom necessary.

The gas burner flame in one of these cabinets not only contributes significantly to the heat build-up; it also disrupts the laminar air streams, which must be maintained for maximum efficiency. **IF THE PROCEDURE DEMANDS USE OF A FLAME, A BUNSEN BURNER WITH ON DEMAND IGNITION IS RECOMMENDED. DO NOT USE CONSTANT FLAME GAS BURNERS.** It should also be only used from the center of the work surface to the right rear where resulting air turbulence will have a minimal effect. **DO NOT USE GAS BURNER ON THE LEFT OF THE WORK SURFACE DUE TO ITS INFLUENCE ON THE ELECTRONIC AIRFLOW CONTROL SYSTEM.** If cabinet air is inadvertently turned off, the flame could damage the HEPA filters.

6.3 Operating Sequence

6.3.1 Start Up

Turn on cabinet blower and lights, check air intake and exhaust portals of the cabinet to make sure they are unobstructed. The electronic airflow control system will automatically control airflows to specified setpoints.

 **NOTE:** Some cabinets are equipped with ultraviolet (UV) lights. Good procedure includes the decontamination or wipe down of cabinet surfaces with chemical disinfectant before work commences. This practice eliminates the need for UV lights, whose primary utility in this application is inactivation of surface contamination since the filters effectively remove all airborne contaminants. UV lights, therefore, are not recommended in the LFBSC.

Allow blowers to operate for a minimum of 15 minutes before aseptic manipulations are begun in the cabinet. If the filtered air exhausted from the cabinet is discharged into the room, as in some installations, an additional advantage is obtained from purification (filtration) of the room air circulated through the equipment. Because of this characteristic contributing to the quality of the laboratory environment, some owners of LFBSC's leave them in operation beyond the time of actual use.

6.3.2 Wipe down

The interior surfaces of the workspace should next be disinfected (see cleaning procedures) by wiping them thoroughly with 70% alcohol or similar non-corrosive anti-microbial agents. **USE OF CHLORINATED OR HALOGEN MATERIALS IN THE CABINET MAY DAMAGE STAINLESS STEEL.**

6.3.3 Materials & Equipment

The apparatus and materials should next be placed into the cabinet. Care must be exercised that no items are placed over the front intake grills. Materials should be arranged so that, clean, dirty, (used), and virus materials are well separated. Passage of contaminated materials over uninoculated cultures or clean glassware should be avoided and transfer of viable materials should be performed as deeply into the cabinet (away from open face) as possible.

6.3.4 Air Purge

Additional purging of the workspace without user activity should be allowed for 2-3 minutes after materials and apparatuses have been placed in it. This will rid the area of all "loose" contamination that may have been introduced with the items.

6.3.5 Perform Work

The work can now be performed. The technician performing the work is encouraged to wear a long-sleeved gown with knit cuffs and rubber gloves. This will minimize the shedding of skin flora into the work area and concurrently protect the hands and arms from viable agent contamination. At a minimum, the hands and arms should be washed well with germicidal soap before and after work in the cabinet. For the preparation of antineoplastic drugs, the following procedures summarize those contained in OSHA's guidelines to Controlling Occupational Exposure to Hazardous Drugs. The OSHA document should be thoroughly studied and reviewed prior to drug preparation in the cabinet. It may be found at this website:

https://www.osha.gov/SLTC/hazardousdrugs/controlling_occex_hazardousdrugs.html

- a. A sterile plastic-backed absorbent drape should be placed on the work surface during mixing procedures. The drape should be exchanged whenever significant spillage occurs, or at the end of each production sequence.
- b. Vials should be vented with a filter needle to eliminate internal pressure or vacuum.
- c. Before opening ampoules, care should be taken to insure that no liquid remains in the tip of the ampoule. A sterile gauze sponge should be wrapped around the neck of the ampoule while opening.
- d. Final drug measurement should be performed prior to removing the needle from the stopper of the vial.
- e. A non-splash collection vessel should be available in the Biosafety Fume Hood/Cabinet to discard excess drug solutions.

6.3.6 Terminal Purging & Wipe down

Following completion of work, allow the cabinet to run for a 2-3 minute period without personnel activity to purge the cabinet. The decontamination of the interior surfaces should be repeated after removal of all materials, cultures, apparatuses, etc. A careful check of grills and diffuser grids should be made for spilled or splashed nutrients, which may support fungus growth, and resulting spore liberation that contaminates the protected work environment.

6.3.7 Paper Catch/Prefilter

A permanent paper catch is installed behind the rear divider panel of the work zone. This area forms the return air path to the motor/blower; and if the airflow is blocked, it could seriously affect the performance of the cabinet. Therefore, **THE PAPER CATCH SHOULD BE CHECKED AND CLEANED NO LESS THAN A WEEKLY BASIS; DAILY** basis if procedures dictate the use of paper products. Any paper removed must be properly disposed of as *Contaminated Hazardous Waste*. The above procedures also apply to all cabinets configured with a prefilter.

6.3.8 Shut Down

Turn off blowers and lights. Do not use cabinet as a depository for excess lab equipment during periods of non-operation. If Antineoplastic agents are being prepared in the cabinet, it is recommended to let the cabinet run 24 hours per day. This lessens the possibility that contaminants may escape.

6.4 Ergonomics

Ergonomics, the study or accommodation of work practices is extremely important for proper cabinet usage and user health and safety. An evaluation of normal work practices should be performed with each user when working in a cabinet. Evaluation criteria should be at a minimum:

- a. Proper user posture
- b. Effective workzone layout for work practice
- c. Vision or sightlines

For each of the above evaluation criterion, several aids may be supplied to accommodate the user.

- Ergonomic chair - A six-way articulating seat and back control for personalized adjustment to assure proper user posture. Be sure feet are resting on the floor, chair foot support or foot rest. Also be sure back is fully supported with proper chair adjustments
- Forearm/armrest support - The cabinet is provided with a forearm support on the work access opening
- Periodic mini-breaks during work practice should be taken resting forearm to avoid stress and fatigue
- Effective workzone layout - Always prepare your work procedure to minimize reach to avoid neck and shoulder stress and fatigue. Rotating tables are optional to maximum workzone and minimize reach
- Vision and sightline - Always prepare your work procedure to eliminate glare and bright reflections on the window. Keep your window clean and sightlines clear to your effect workzone

6.5 Cleaning Procedures

6.5.1 General

Cleaning laboratory equipment is important in terms of both functionality and general good housekeeping. The information provided below is intended to aid the development of facility Standard Operating Procedures (SOP's) for cleaning the equipment. It is strongly recommended that all cleaning materials used be tested and verified in terms of both effectiveness and material compatibility before they are written into the cleaning SOP documentation.

- a. The airflow blower should be operating during the cleaning process to maintain sterility and/or containment during the cleaning process.
- b. Raise window to gain additional access if desired.
- c. Apply appropriate cleaning material or surface disinfectant to surfaces. Most surface disinfectants require a specific contact time depending the materials used within the work zone. **CONSULT APPROPRIATE DISINFECTANT DOCUMENTATION FOR PROPER APPLICATION AND SAFETY PRECAUTIONS.**
 - c-1. Stainless steel (type 304) has noted material compatibility concerns with Acids, Chlorides and Halogens. **IF THESE MATERIALS ARE USED AND ALLOWED TO BE LEFT ON THE STAINLESS STEEL SURFACE, OXIDATION AND DEGRADATION WILL OCCUR.** Only by re-wiping surfaces with either sterile water or 70% IPA will remove harmful materials from the stainless steel surface.

Further information is available at the following: http://www.parrinst.com/wp-content/uploads/downloads/2011/07/Parr_Stainless-Steels-Corrosion-Info.pdf

NOTE: Nuair does not offer any product warranty with respect to cleaning material compatibility. **USE AT YOUR OWN RISK!** The information provided above is from raw material suppliers and known general source documents for use to develop application cleaning SOP's.

- ☞ NOTE: When cleaning the work area for the first several times, the new metal surfaces may produce some dark discoloration on the white cleaning wipes. Repeated cleaning will continuously reduce the amount of the discoloration material on the cleaning wipes over time.

6.6 Hazardous Drug Decontamination Procedures

This procedure is intended to provide guidance following a spillage and/or periodic maintenance, testing or relocation of the cabinet. Additional guidance can be provided by the CETA document CAG-005-2007 found at the CETA website: www.CETAinternational.org.

6.6.1 Preparation

Prior to beginning decontamination activity, personnel should wear proper personnel protection equipment (PPE) i.e. Tyvek¹ isolation gown, 2 pair of Nitrile gloves and a full-faced HEPA filtered respirator. All protective garments should be contained in 4 mil plastic bags and labeled for disposal as chemotherapy waste after completion of the procedure. For the purpose of this procedure, detailed procedures for cleaning a Class II LFBSC can be found in the 2006 ASHP Technical Assistance Bulletin ASHP Guidelines on Handling Hazardous Drugs².

6.6.2 Procedure

- a. Make sure that the cabinet remains in operational mode with internal blower on.
- b. Open the hinged or sliding view screen and secure in the full open position.



With the view screen in the full open position, personnel protection is compromised and a full faced HEPA filtered respirator must be worn.

- c. Clean all readily accessible surfaces of the cabinet.
- d. Remove perforated metal diffuser screen from the underside of the supply HEPA filter and place on the cabinet work tray.

- ☞ **NOTE:** Depending on the model, the diffuser screen is secured to the cabinet by #8-32 screws or 1/4" - 20 acorn nuts, 3 places. It is purposely a tight fit and is secured to the back wall with projecting thread-less studs.

- e. Clean both sides of the perforated metal diffuser screen and remove it from the cabinet.
- f. Lift the cabinet work tray, clean both sides and remove it from the cabinet.
- g. Remove the front perforated grill, place on the cabinet floor and clean both sides. Remove from cabinet.
- h. Clean work tray supports.
- i. Working from top to bottom, clean all inside surfaces of the cabinet. Take care **not** to wet the HEPA filter. If liquid has collected in the plenum drain, aspirate it using IV tubing into an evacuated container. Label the evacuated container for disposal as chemotherapy waste.
- j. Clean the plenum drain area and wipe dry.
- k. If the cabinet requires maintenance and/or replacement of the HEPA filters, the operation should be halted at this point to allow trained personnel to complete replacement of the HEPA and/or maintenance action required.

6.6.3 Assembly

- a. Replace front (if removed) grill.
- b. Replace the work tray and carefully tighten the thumbscrews.
- c. Replace perforated metal diffuser screen over the underside of the supply HEPA filter.
- d. Wipe down all exposed surfaces of the work area with 70% isopropyl alcohol.
- e. Prepare for aseptic operation.

¹ Available from Lab Safety Supply, Janesville, WI 53547-1368, or other laboratory, industrial, or hospital supply distributors.

² American Society of Hospital Pharmacists. 2006. ASHP Guidelines on Handling Hazardous Drugs *Am. J. Hosp. Pharm.* 63:1172-1193.

7.0 General Maintenance

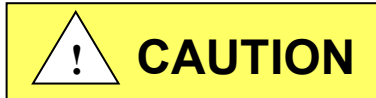

All maintenance actions on this equipment must be performed by a qualified technician who is familiar with the proper maintenance procedures required for this equipment. This includes both certification as well as repair.

7.1 Decontamination

No maintenance should be performed on the interior of the LABGARD® ES cabinet (area behind access panels) unless the cabinet has been microbiologically decontaminated, is known to be biologically clean, or known to be chemically inert. Surface disinfection is performed as specified in the cleaning procedures.



Hazardous Gases! Personal Protection Equipment Required.



A disinfection using formaldehyde must be performed in accordance with the specifications of NSF/ANSI 49, Annex G.

This procedure presents considerable risks and must be performed only by specially trained and authorized service personnel in accordance with applicable safety regulations.

The formaldehyde is vaporized within the tightly sealed sample chamber. The quantity of the applied formaldehyde depends on the volume of the sample chamber in the safety cabinet that is to be disinfected. The formaldehyde evaporates immediately after reaching its boiling point; the minimum reaction time is 6 hours. Therefore, the formaldehyde should be neutralized after the specified reaction time by vaporizing ammonium bicarbonate.

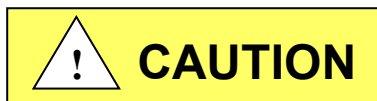

Flammable Hazard!



Paraformaldehyde is flammable. The auto-ignition temperature of paraformaldehyde is 300° C (572° F).

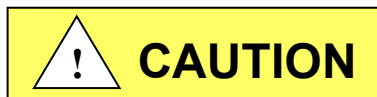

Chemical Hazard!



Paraformaldehyde in reaction with hydrogen chloride will form BCME which is a hazardous chemical. When using paraformaldehyde, all residues of hydrogen chloride in the work chamber of the cabinet must be removed.

If microbiological decontamination is necessary, use the following procedure:

1. Remove screws at each upper side of the control center and allow the control center to rotate down, resting on the safety straps. Remove control center by disconnecting safety straps and moving control center off the slip hinges.
2. Remove the front decorative panel via top/front fasteners.
3. Remove left and right window faring's via fasteners.
4. Remove armrest via fasteners.
5. Prepare decontamination equipment. Reference decontamination procedure, per NSF/ANSI 49, Annex G, using the following chart to calculate chemical requirements.

Cabinet Size	400	600
Cabinet Dimensions	58 7/8 x 28 x 46-3/8 (1.5 x .711 x 1.18 m)	58 7/8 x 28 x 70-3/8 (1.5 x .711 x 1.8 m)
Cabinet Volume	44.24 cu. ft. (1.25 cu. m)	67.14 cu. ft. (1.90 cu. m)

 **NOTE:** The outlets in the work area are energized as long as the cabinet is plugged in and switched on the front panel. Unplug the cabinet before decontamination equipment is plugged into these outlets or run the decontamination power cords under the front seal area.

- Use duct tape and plastic to seal the front and exhaust area.

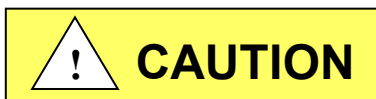

BE SURE CABINET IS TOTALLY SEALED TO PREVENT ANY LABORATORY EXPOSURE TO DECONTAMINATION GAS. VAPOR OR MIST.

- Perform decontamination procedure per NSF/ANSI 49, Annex G.

If the cabinet has been used to prepare hazardous drugs, (chemotherapy), or other toxic chemicals, decontamination of the cabinet **cannot** be accomplished by the above procedure. (See section 6.6 for guidelines)

Please consult with Nuaire, Inc. about any unique contamination problems.

Normally, no preventive maintenance is required on the interior of the cabinet (i.e., the area behind the access panel containing the HEPA filters and motor (blower assembly). All required adjustments in order to maintain proper cabinet airflows are external to the cabinet interior. The motor is lubricated for life and is thermally protected with automatic reset.

7.2 LED Lamp Replacement

The two (T8) LED lamps are cool white, rapid start and placed external to the cabinet to aid maintenance and minimize heat build-up within the cabinet. The B70 life rating of the lamp is 50,000 hours based on 80,000 switching cycles.

To replace a bulb, it is necessary to remove the lamp assembly.

- Switch Cabinet Light Switch off.
- Remove the screws at each upper side of the Control Center and allow the Control Center to rotate down, resting on the safety straps.
- The lamp is now directly exposed for replacement.
- The lamp is removed by displacing the bulb to one side against the compressible lamp holder and lifting out the lamp.
- Reverse the procedure to reinstall the lamp assembly being careful not to pinch the safety straps, cable or tubing during closure of the control center.

Description:	Supply HEPA Filter	Exhaust HEPA Filter (UL 586)
Efficiency:	99.99% @ 0.3 Micron	99.99% @ 0.3 Micron
Airflow Rating:	100 fpm @ .55 ± .05" w.g. per sq. ft.	250 fpm @ .45 ± .05" w.g. per sq. ft.
Frame Type:	Metal	Metal
<u>NU-565-400</u>		
Nuaire Part Number:	A-980979-01	A-980845-03
Filter Size:	21" (533mm) x 44" (1118mm) x 3" (76mm)	20" (508mm) x 22" (559mm) x 11 1/2" (292mm)
Filter Manufacturer:	Camfil Farr/FG/AAF	Camfil Farr/FG/AAF
<u>NU-565-600</u>		
Nuaire Part Number:	A-980979-03	A-980845-04
Filter Size:	21" (533mm) x 68" (1727mm) x 3" (76mm)	20" (508mm) x 36" (914mm) x 11 1/2" (292mm)
Filter Manufacturer:	Camfil Farr/FG/AAF	Camfil Farr/FG/AAF

When installing new filters, **USE ONLY NUAIRE SPECIFIED FILTERS FOR REPLACEMENT.**

7.3 HEPA Filter/Motor Replacement

The HEPA Filters under normal usage and barring an accident (a puncture), do not need replacement until the exhaust volume cannot be maintained or the access inflow velocity cannot be maintained at 100 LFPM (min.) .51 m/s). This may permit the average downflow velocity to be as low as 55 LFPM (.28 m/s) as long as no point falls below 20 percent of the average downflow velocity.

The HEPA Filters should not be replaced until the entire cabinet has been decontaminated or known to be biologically "clean". Constant pressure spring-type clamps are used to hold the exhaust filter tightly in place to counteract seal relaxation, while the supply filter employs Nuaire's HEPEX pressure plenum. **USE ONLY REPLACEMENT FILTERS OF THE SAME RATED FLOW AND SIZE AS ORIGINALLY INSTALLED, TO INSURE PROPER AIRFLOW BALANCE CAN BE ACHIEVED.**

It is not always necessary to replace both the supply and exhaust filters at the same time. In fact, it is highly likely that the exhaust filter will need replacement far more often than the supply filter, due to (1) the larger volume of air passing through it, (2) it's much smaller size, and (3) the capability of the exhaust system.

7.3.1 Supply Filter Replacement (see Drawing BCD-19032)



Disconnect electrical power from the cabinet before attempting any maintenance action.

Step 1: Remove screws at each upper side of the control center and allow the control center to rotate down, resting on the safety straps. Second, remove the front decorative panel, which is held into position by (3) screws on the top edge.

Step 2: Place sliding window into lowest position and remove front filter panel, which is held into position by Phillips pan head screws. Once the screws are removed, remove the panel.

 **NOTE: Screws are used in lieu of acorn nuts, and lock washers. The screws have O-rings and should be replaced if damaged or badly deformed.**

Step 3: Remove filter access panel, which is held into position by screws. Remove screws and the panel.

The interior of the cabinet is now fully exposed for replacement of the filter.

Step 4: To remove the supply filter:

- a. Remove plenum screws in front of supply HEPA filter.
- b. Lift the permanent plenum and hold up with wire strap.
- c. Carefully remove the supply filter.



DIRECT EXPOSURE SHOULD BE AVOIDED, EVEN THOUGH THE FILTER IS IN AN UNCONTAMINATED PLENUM.

Step 5: To install the supply filter, simply reverse the procedure outlined in the steps above.



7.3.2 Exhaust Filter Replacement

Step 1: Remove exhaust filter access panel, which is held into position by screws. Remove the screws and panel.

Step 2: Locate the external single point release bolt on the top right hand side of the cabinet.
Use a 5/16-inch (8mm) wrench to release the exhaust filter rotating counter clockwise.

Step 3: Carefully remove the exhaust filter.

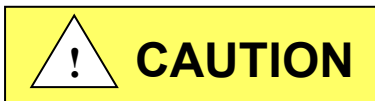

Dispense of spent HEPA filters properly.

Avoid direct contact to "dirty side" of the filters.

Place in sealed bag and label waste containers/cartons based on the type of hazard. Follow all Local, State and Federal guidelines for disposal of HEPA filter solid waste.

When installing the new filter, apply a thin layer of silicone grease to the gasket of the filter and carefully insert into exhaust chamber. Tighten HEPA seal frame (clockwise) until the gasket is visually depressed by 1/8 inch (3mm). The procedure for replacing the exhaust filter with the Bag-in/Bag-out option is shown on Drawing BCD-05660.

7.3.3 Motor/Blower Assembly Removal

- a. It is recommended that the motor/blower to be removed as a single unit. To remove, disconnect electrical connections to the motor, remove the HEPEX pressure plenum and unbolt the motor/blower assembly from the roof of the cabinet (4 places). Always inspect the rubber isolation motor mounts and replace those that are cracked or visibly show stress.
- b. Replace the motor exactly as originally installed in the blower housing, paying particular attention to the correct electrical connections (see Electrical Schematic).
- c. Re-install the new motor/blower assembly.

7.4 Sliding Window Replacement and Manual Adjustment

The sliding window replacement is accomplished by removing the front decorative panel, control center, and window glide assemblies. The sliding window adjustment may be required due to everyday use over the life of the cabinet. Both window glides are adjustable by a set screw and tension screw method. When adjusting the sliding window, be sure to verify proper micro switch operation. If the sliding window is too loose, it will not properly activate the micro switches, thus causing potential operational malfunctions to occur.

REV ECD	DESCRIPTION	DATE	INL	INL
A	4900 RELEASED TO PRODUCTION	11/28/95	TV	

STEP 1. REMOVE THE FRONT COVER AND THE EXHAUST FILTER COVER. NEXT, LOOSEN THE EXHAUST FILTER PRESSURE FRAME USING THE LEAD SCREW TO DO SO. USE ENCLOSED TOOL TO PRY AND LOOSEN FILTER. REMOVE SHELF SUPPORTS FROM INNER FRONT COVER AND ATTACH TO COVER MOUNTING STUDS AT FILTER END. PULL THE OLD FILTER INTO THE BAG OUTSIDE THE CABINET ONTO A SUPPORT SHELF. NOTE: BE SURE BAG IS SECURELY ON FRAME. IF NEEDED USE DUCT TAPE TO SECURE.

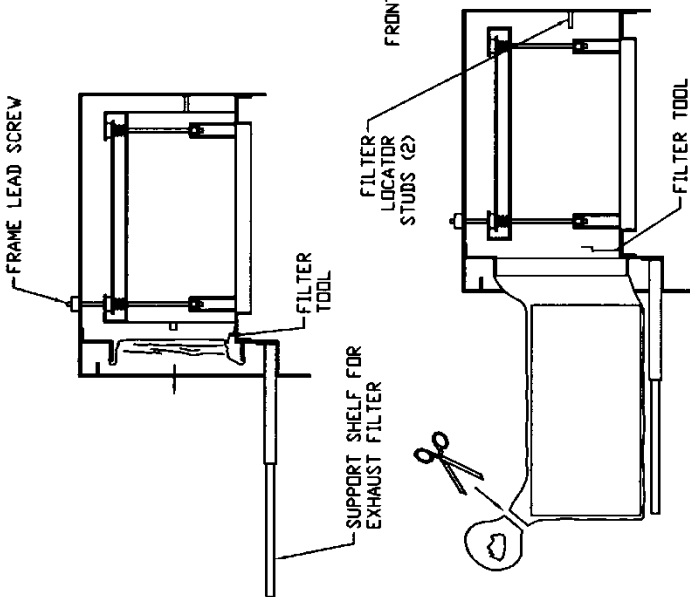

STEP 2. HEAT SEAL AT A POINT BETWEEN THE OLD FILTER AND THE BAG-IN/BAG-OUT FLANGE. HEAT SEALED AREA SHOULD BE WIDE ENOUGH SO THAT WHEN THE BAG IS CUT WITH THE SCISSORS, THE SEAL REMAINS INTACT ON BOTH SIDES OF THE CUT. OR HEAT SEAL TWO SEAMS AND CUT BETWEEN THE TWO. DISPOSE OF THE CONTAMINATED FILTER. RETAIN FILTER TOOL NEAR BAG-IN/BAG-OUT FRAME.

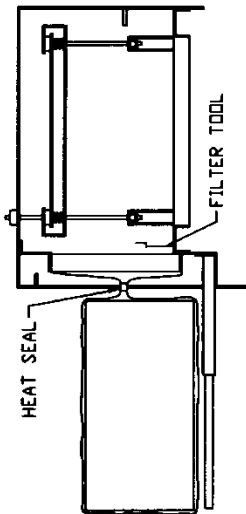

STEP 3. PUT THE NEW FILTER IN A CLEAN PLASTIC BAG. BE SURE TO ADD A SMALL AMOUNT OF SILICON GREASE TO FILTER GASKET BEFORE PUTTING IN PLASTIC BAG. SECURE THE NECK OF THE NEW BAG OVER THE OLD DUCT TO THE FLANGE OF THE BAG-IN/BAG-OUT RING. AGAIN USE DUCT TAPE AS NECESSARY TO SECURE.

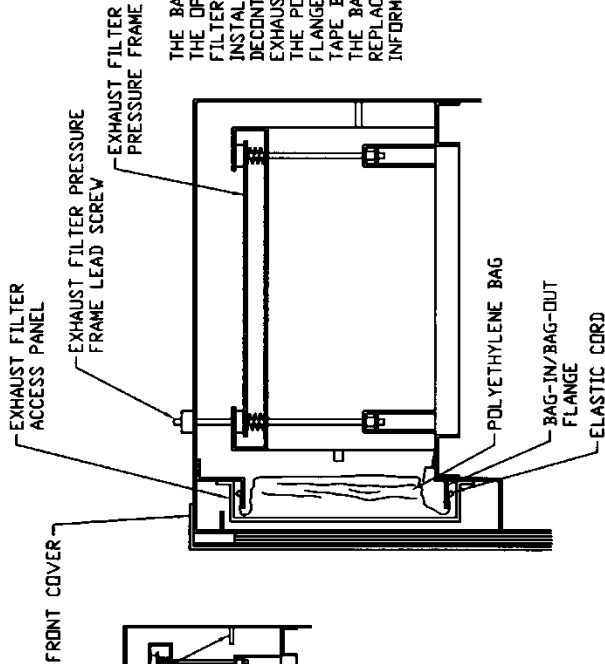
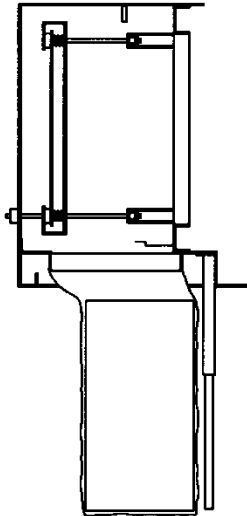

THE BAG-IN/BAG-OUT PROCEDURE MAINTAINS A BARRIER BETWEEN THE OPERATOR AND DANGEROUS MATERIAL. THE CONTAMINATED FILTER CAN BE REMOVED FROM THE AREA AND A NEW FILTER INSTALLED WITHOUT EXPOSING PERSONNEL. SEAL CABINET AND EXHAUST FILTER REPLACEMENT PROCEDURE. PLEASE NOTE THAT THE POLYETHYLENE BAG IS SECURED TO THE BAG-IN/BAG-OUT FLANGE WITH AN ELASTIC CORD. IT IS RECOMMENDED THAT DUCT TAPE BE ADDED TO THIS AREA TO AID IN HOLDING THE BAG ONTO THE BAG-IN/BAG-OUT FLANGE. DURING THE EXHAUST FILTER REPLACEMENT PROCEDURE. REFER TO STEP 1-4 FOR DETAILED INFORMATION.

STEP 4. PULL THE OLD BAG STUB AWAY FROM THE BAG-IN/BAG-OUT FLANGE AND WORK INTO THE REAR OF THE NEW BAG. HEAT SEAL AND CUT OFF THE PORTION CONTAINING THE OLD BAG STUB. PUSH NEW FILTER INTO THE CABINET UNTIL IT TOUCHES THE REAR FILTER LOCATOR STUDS AND RE-CLAMP THE EXHAUST FILTER PRESSURE FRAME. FOLD THE NEW BAG INSIDE CAVITY AND REPLACE THE EXHAUST FILTER COVER. FILTER/SEAL INTEGRITY CHECK MAY NOW BE MADE.

NUAIR PLYMOUTH, MINNESOTA	
NU-427,430,435	BAG-IN/BAG-OUT EXHAUST REMOVAL PROCEDURE
DFTM TW 11/27/95	SHEET 1 OF 1
DRAWING NUMBER	BCD-05660 A

7.5 Airflow Control System Setup and Calibration



Failure to calibrate airflow to the specified requirements may result in unsafe conditions of performance (i.e. product and/or personnel protection, noise and vibration)

7.5.1 General

The operation of the NU-565 cabinet requires that the setup and calibration procedures be performed in order to certify or commission the cabinet for usage. The setup and calibration procedures performed **ONLY BY THE CABINET CERTIFIER** ensure that cabinet's setpoints are verified and that the airflow monitor sensors are calibrated to read the correct values. Press MENU to access Calibration/Service parameter.

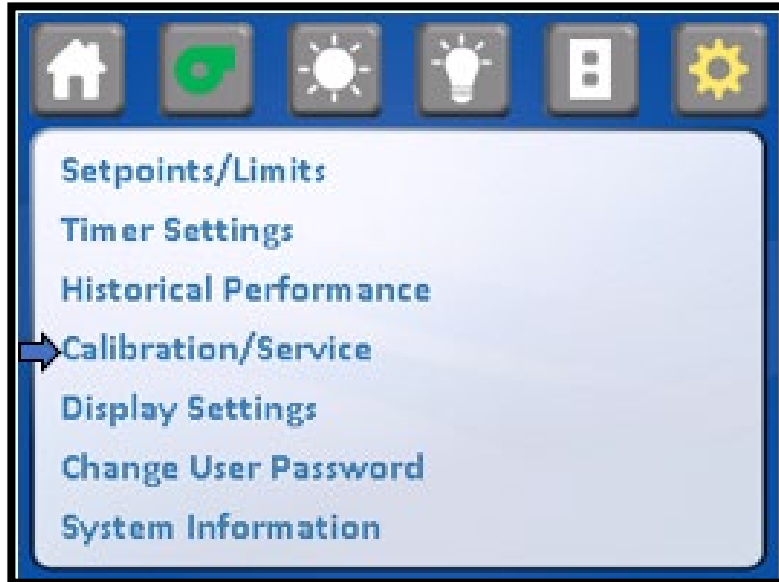

Entry into the Calibration/Service functions requires a service password for entry. After pressing the Calibration/Service menu item, a password screen will appear. The default password is "9876". Once the service password is entered, the Calibration/Service menu will appear. To exit, either press the menu or home icon.



One additional feature for service technicians is to bypass the whole 2 minute warmup time. By pressing the word warmup, the system will move directly to run. It is recommended that at least a minute of warmup time be observed, so the airflows can stabilize at their setpoints to avoid an alarm condition.

7.5.2 Calibration/Service Menu

The Calibration/Service menu provides a list of sub-menu items to accomplish all service tasks. Each sub-menu item will be described in the following sections

For airflow calibration, only the first three sub-menu items are used in the calibration process.



7.5.2.1 Cabinet Type/ Motor Type

The cabinet type can be verified in the control system and is factory set and shouldn't require alteration. The cabinet type default information controls unit of measure, setpoints and limits based on the type and size of cabinet. The OEM displayed menu item references the LOGO style displayed Nuaire being the default.

To verify, press CABINET TYPE. The current type of cabinet will be designated. Again to verify, press the correct Type and the Model/Size of the current selected cabinet model will be designated. Once verified the correct type and model are designated, then press BACK to return to Calibration/Service menu.

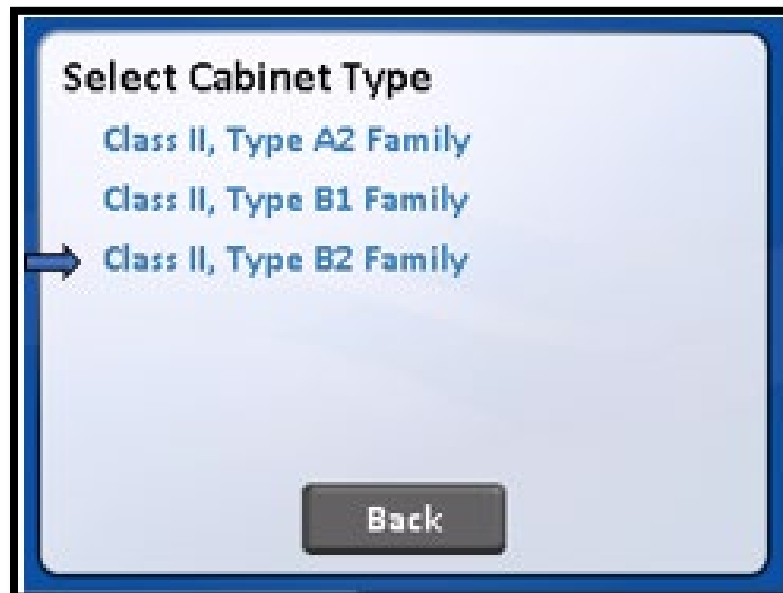

If the LFBS has a special downflow area (workzone), exhaust duct diameter size or special work access opening window height, these must be entered into the control system to assure the correct display values. Press MENU to access these additional parameters. Select and SAVE appropriate size of each

Select Cabinet Opening

8 Inch
 10 Inch
 12 Inch

Back **Next**

Enter Downflow Area

5.790

1	2	3
4	5	6
7	8	9
CLR	0	←

Min
1.000
Max
90.000

Cancel **Enter**

Select Exhaust Opening

8 Inch Diameter
 10 Inch Diameter
 12 Inch Diameter
 14 Inch Diameter

Back **Next**

Press SET MOTOR TYPE to verify correct setting.

Upon a MASTER RESET, the motor type is defaulted to DC ECM Single.

The NU-565 Series 1 (115Vac) requires the motor type selected to be DC ECM Single.

Always verify motor type when verifying cabinet type.

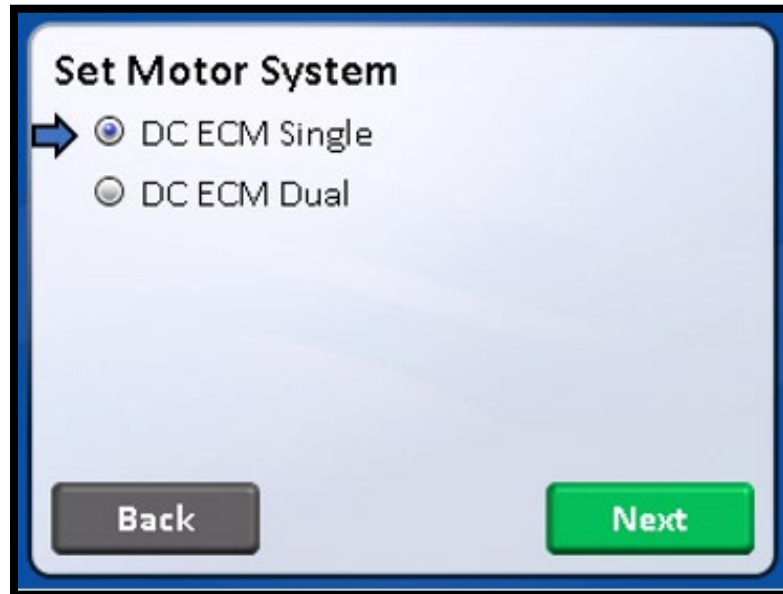

7.5.2.2 Setpoints/Limits

The airflow setpoints and alarm limits may also be verified or altered. Typically, these default values are factory set based on the cabinet type, model and size as previously discussed. However, they may be altered in special cases for modified cabinets. The setpoint establishes the airflow values that are to be maintained

The high low limits establish the alarm boundaries from the nominal setpoint. The default values have been established based upon the performance specifications and cabinet component tolerances.

Entry into the setpoints/limits functions requires a service password for entry. The default password is "9876"

A control panel interface with a top navigation bar containing icons for Home, a green circular arrow, Sun, Lightbulb, a vertical bar with two dots, and a Gear. Below the icons is a list of settings with corresponding value boxes:

Downflow Setpoint	60 fpm
Downflow High Limit	66 fpm
Downflow Low Limit	54 fpm
Exhaust Setpoint	548 cfm
Exhaust High Limit	630 cfm
Exhaust Low Limit	466 cfm

Enter Password
XXXX

A numeric keypad with buttons for digits 1-9, 0, CLR, a left arrow, a checkmark, and an 'X' (cancel) button.

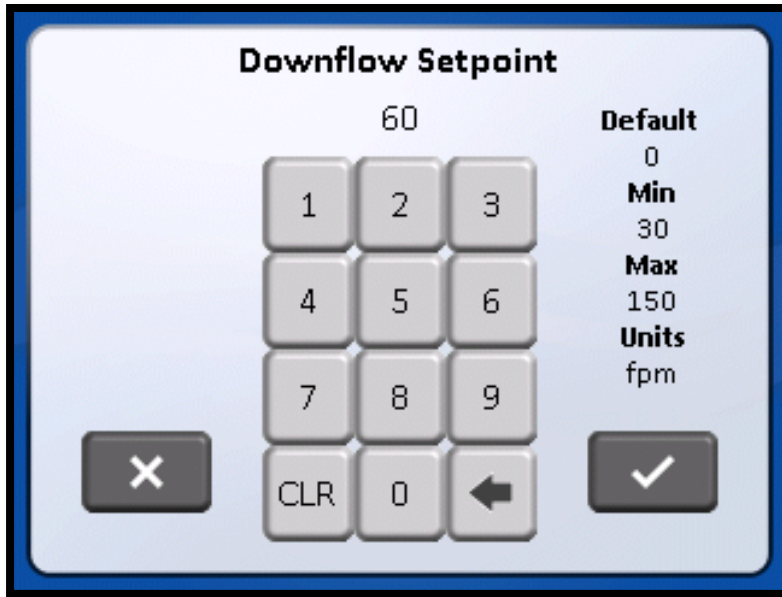

Default values for NU-565-400

- Downflow setpoint - 60
- Downflow high limit - 66
- Downflow low limit - 54
- Exhaust setpoint - 740
- Exhaust high limit - 851
- Exhaust low limit - 629

Default values for NU-565-600

- Downflow setpoint - 60
- Downflow high limit - 66
- Downflow low limit - 54
- Exhaust setpoint - 1122
- Exhaust high limit - 1290
- Exhaust low limit - 954

7.5.3 Airflow Calibration

The NU-565 Airflow Calibration consists of adjustments to balance the airflow within the cabinet and the calibration of the airflow monitor sensors. **THIS WORK SHOULD BE DONE ONLY BY A QUALIFIED TECHNICIAN WHO CAN MEASURE THE AIRFLOW FROM THE FILTERS WITH A SUITABLE VELOMETER.** Nuair provides one adjustment to balance the airflow within the cabinet. This is: PWM signal adjust via DC ECM motor control system

The blower speed control system adjusts the cabinet's supply volume of airflow while customer supplied exhaust system controls the exhaust volume of airflow. Since it has been Nuair's experience that the filters may not "load" evenly, both adjustments are necessary for proper cabinet performance.

The cabinet is considered to be certifiable if the following airflow measurements are present:

- a. Downflow average: 60 LFPM \pm 5 LFPM (.30 m/s \pm .025 m/s).
- b. Inflow average: 105 LFPM \pm 5 LFPM (.53 m/s \pm .025 m/s) using the Direct Inflow Measurement (DIM) method or alternate 3" constricted inflow velocity measurement method.

The calibration of the airflow monitor sensors occurs during the cabinet airflow balancing procedure. The calibration procedure consists using the downflow and inflow averages achieved and entry of those values into the control system.

7.5.3.1 Exhaust Volume Calibration without the NU-951-012 Motorized Butterfly Valve

- Step 1: Activate power to the cabinet
Turn on exhaust system
Access sensor setup menu
- Step 2: Access calibrate downflow sensor menu and spot check a few downflow points to verify downflow is close to the desired setpoint of 60 fpm \pm 5 fpm. Adjust if necessary.

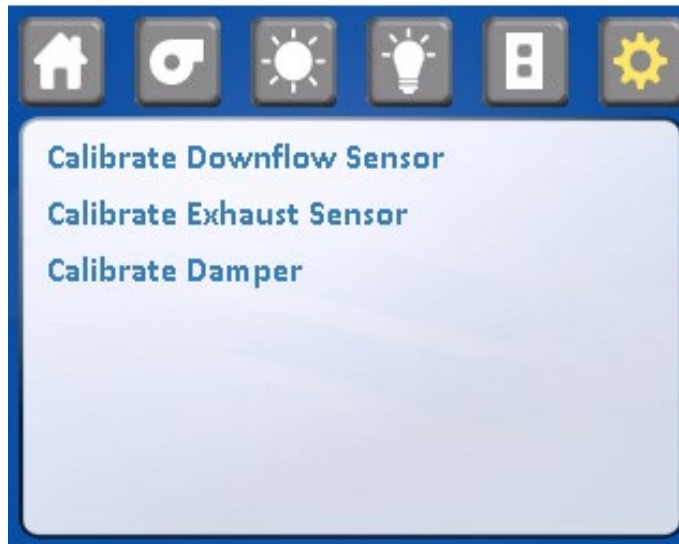

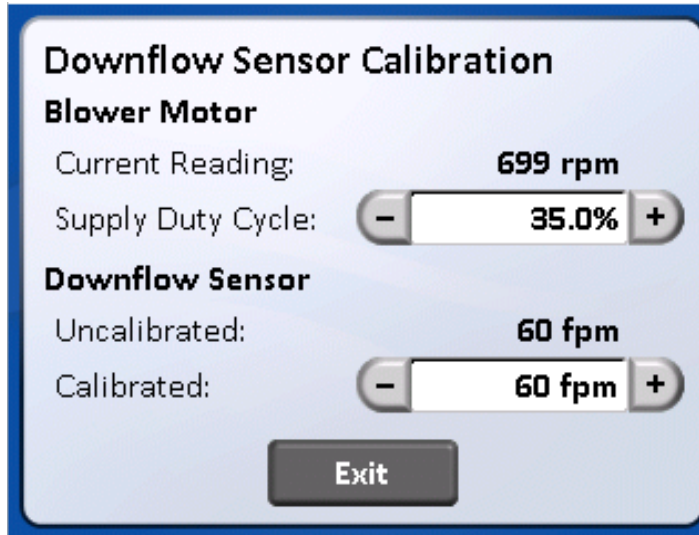

Step 3: Now, access the calibrate exhaust sensor menu and measure inflow velocity using the recommended procedure found in Table 7.0.

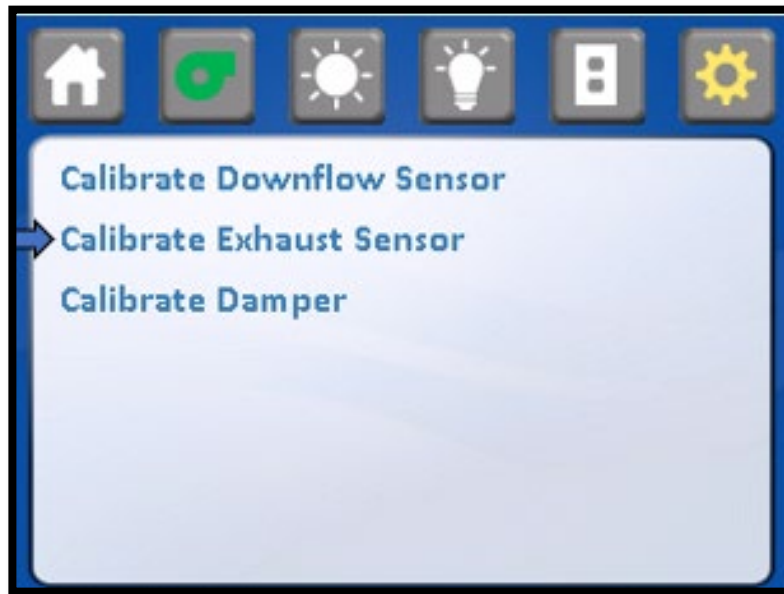

If necessary, adjust the exhaust system to achieve the correct inflow velocity. Use Table 7.1 to relate downflow and exhaust/inflow volumes and corresponding average airflow velocities. It is always desirable to achieve airflow values that are set as close as possible to nominal. This is especially applicable to the inflow velocity and its relation to exhaust volume, since the exhaust sensor only monitors the exhaust airflow. If the inflow velocity is calibrated at the outer edge of

the range, a greater chance for alarm conditions would exist due to its closer proximity to the alarm limits.

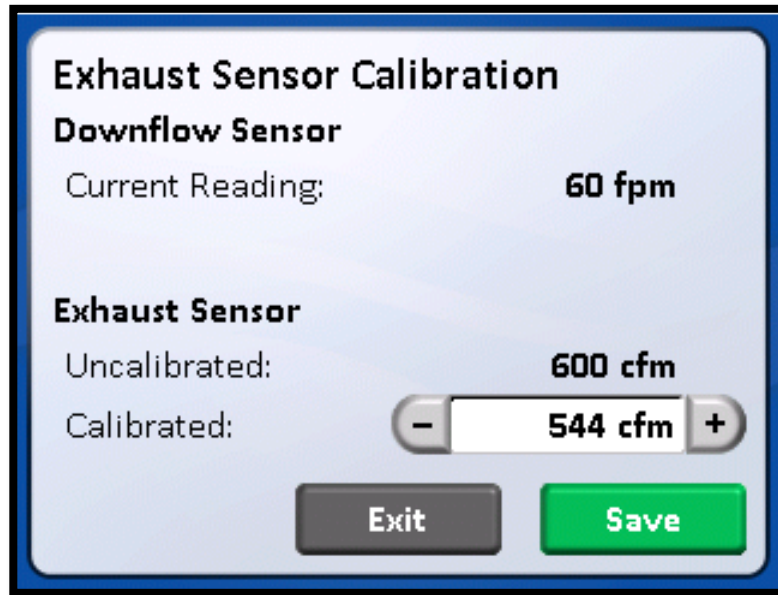

Press +/- to change exhaust volume to the value just calculated using the inflow volume.

 **NOTE:** Assume downflow velocity is at the nominal value of 60 fpm for exhaust volume calculation purposes as it will be adjusted during the downflow calibration process.

Press SAVE to enter the exhaust volume value. Exit out of calibration menu by pressing the home icon and leave motor/blower off.

Step 4: Verify the operation of the manual mode pressure switch at this point. Lower the exhaust volume to 100 CFM (170 CMH) lower than the standard exhaust lower alarm limit.

- Turn off motor/blower
- Block off supply-air intake using cardboard.
- Lower exhaust volume to the pressure switch low trip point stated below.

Model	Low Alarm Limit CFM (CMH)	Pressure Switch Low Trip Point CFM (CMH)
NU-565-400	629 (1069)	529 (899)
NU-565-600	954 (1621)	854 (1451)

If present, remove cardboard from supply-air intake and turn ON the unit's blower if it is not ON now. Remove 1 screw from each of the top right and left sides of the control box and rotate control box forward to access the pressure switch adjustment. Pressure switch must be adjusted while control box is open. Adjust as needed (the adjustment dial), until the internal supply blower/motor is deactivated. Then raise the exhaust volume back up to the standard lower alarm limit to ensure the internal supply blower/motor turns back ON. Finally, adjust the exhaust system back to the correct inflow velocity and exhaust volume. Reattach control box and test the activation/deactivation of the pressure switch again when the control box is back in the vertical position.

Step 5: If present, remove direct reading instrument from window access open area and proceed to downflow calibration

7.5.3.2 Exhaust Volume Calibration with the NU-951-012 Motorized Butterfly Valve

To activate the exhaust control, perform the following:

Select Option Set Up.

Step 1: Activate power to the cabinet

Turn on exhaust system and make sure damper actuator is plugged into the 3 position connector on the top right side of the cabinet.

Access sensor setup menu

Step 2: Access calibrate downflow sensor menu and spot check a few downflow points to verify downflow is close to the desired setpoint of 60 fpm \pm 5 fpm. Adjust if necessary.

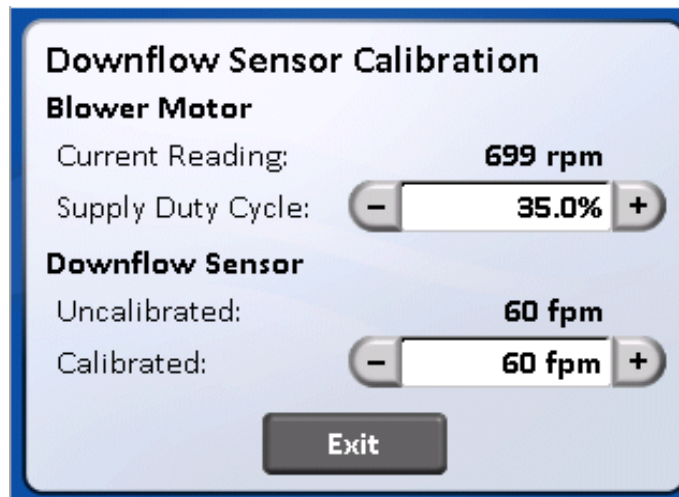

Step 3: Set damper position to 60° on the display. Nuaire recommends using the damper position at 60° to minimize static loss and maximum controllability of the system. However, **THE DAMPER CAN RANGE FROM 35° TO 75° FOR ITS NOMINAL SETPOINT. ANY POSITION OUTSIDE THIS RANGE WILL SEVERELY LIMIT THE CONTROL SYSTEMS ABILITY TO ACCURATELY CONTROL THE EXHAUST VOLUME.** If possible, adjust exhaust volume with damper at 60° for maximum control.

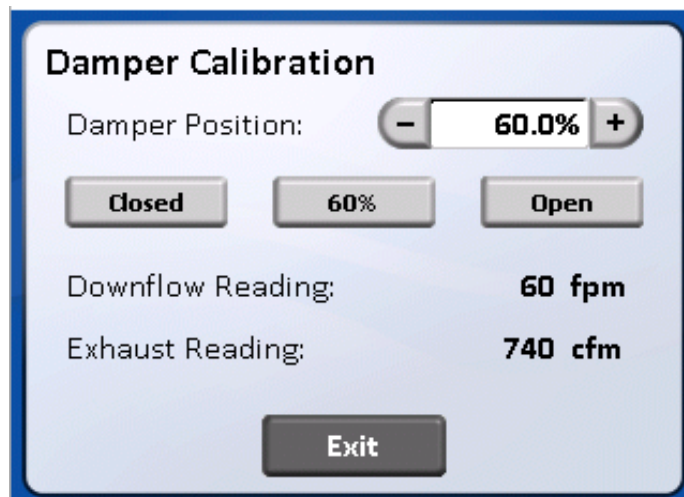
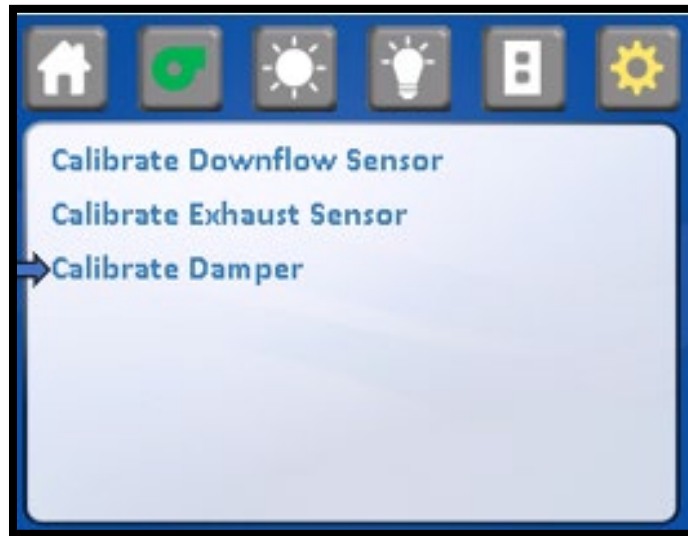

Step 4: Now, measure inflow velocity using the recommended procedure found in Table 7.0. If necessary, adjust the exhaust system and/or damper to achieve the correct inflow velocity. Use Table 7.1 to relate downflow and exhaust/inflow volumes and corresponding average airflow velocities. It is always desirable to achieve airflow values that are set as close as possible to nominal. If the inflow velocity is calibrated at the outer edge of the range, a greater chance for alarm conditions would exist due to its closer proximity to the alarm limits.

- Once damper position and/or exhaust volume is set, press SAVE to enter the damper position.
- Press -/ + to change exhaust volume to the value just calibrated using the inflow volume.

 **NOTE:** Assume downflow velocity is at the nominal value of 60 fpm for exhaust volume calculation purposes as it will be adjusted during the downflow calibration process.

Press SAVE to enter the exhaust volume value. Exit out of calibration menu by pressing the home icon and leave motor/blower off.

Step 5: Verify the operation of the manual mode pressure switch at this point. Lower the exhaust volume to 100 CFM (170 CMH) lower than the standard exhaust lower alarm limit.

- Turn off motor/blower
- Block off supply duct connection using cardboard.
- Lower exhaust volume to the pressure switch low trip point stated below

Model	Low Alarm Limit	Pressure Switch Low Trip Point
	CFM (CMH)	CFM (CMH)
NU-565-400	629 (1069)	529 (899)
NU-565-600	954 (1621)	854 (1451)

If present, remove cardboard from supply-air intake and turn ON the unit's blower if it is not ON now. Remove 1 screw from each of the top right and left sides of the control box and rotate control box forward to access the pressure switch adjustment. Pressure switch must be adjusted while control box is open. Adjust as needed (the adjustment dial), until the internal supply blower/motor is deactivated. Then raise the exhaust volume back up to the standard lower alarm limit to ensure the internal supply blower/motor turns back ON. Finally, adjust the exhaust system back to the correct inflow velocity and exhaust volume. Reattach control box and test the activation/deactivation of the pressure switch again when the control box is back in the vertical position.

Step 6: If present, remove direct reading instrument from window access open area and proceed to downflow calibration

7.5.3.3 Downflow Calibration

 **NOTE:** If already in Calibration/Service menu, select sensor setup.

Step 1: Access Calibration/Service menu.

Press sensor setup menu item to access sensor calibration menu.

Step 2: Press calibrate downflow sensor to access individual calibration screen. Blower will automatically be switched to on. Allow blower to run for one minute or until downflow readings are steady.

Step 3: Place a velometer in the cabinet workzone on the horizontal plane 4 inches (102mm) above the bottom edge of the window. Spot check several points on the recommended downflow velocity

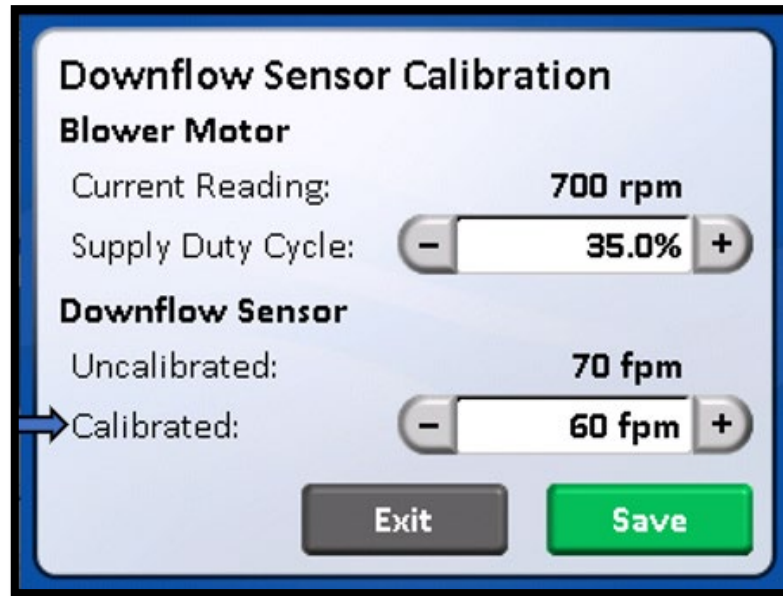

Step 4: Press + or – button of supply duty cycle to adjust blower speed. The objective of this spot check is to obtain the desired downflow average velocity as close as possible to the stated goal of 60 LFPM (.30 m/s).

DON'T SPEND MORE THAN 5 MINUTES SPOT CHECKING.

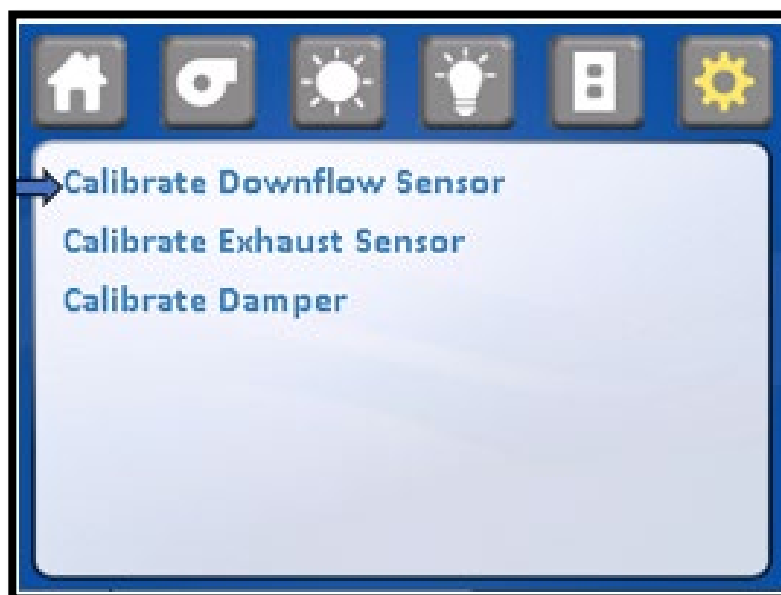

Step 5: Now, measure the average downflow velocity over the entire workzone using the recommended downflow velocity test grid (see Table 7.0).

Step 6: Press +/- to change the calibrated downflow value to the average downflow velocity just found. Press SAVE to enter both the supply duty cycle and the new calibrated downflow value. Now, the downflow monitor sensor has been calibrated to the actual measured average downflow velocity. The cabinet will now control to the downflow setpoint.

- Now, the calibration procedure is complete. If desired, a spot check in the downflow velocity may be performed if felt necessary.
- Press home icon to exit into run mode.

7.5.3.4 Night Setback Calibration (Optional)

The night set back calibration is performed within the calibration mode after the inflow and downflow calibration procedure is complete.

 **NOTE:** If night setback exhaust airflow is reduced by the Building Automation System (BAS) and not by the Nuaire model NU-951-012 valve, this calibration procedure is not necessary. However, it would still be recommended to use the contacts on the main control board to initiate the night setback option to display night setback active, inhibit exhaust alarms, light, and internal blower.

Select Night Setback



- Step 1: Determine how night setback is initiated. If using contacts on main control board, proceed to step 2:
- Step 2: If using the display icon, enable night setback option by performing the following:
Turn ON night setback option

When the Night Setback option ON the Night Setback icon will appear ON the display to turn night set

back ON/OFF. Press home icon the save screen pop up, press save to enter selection.

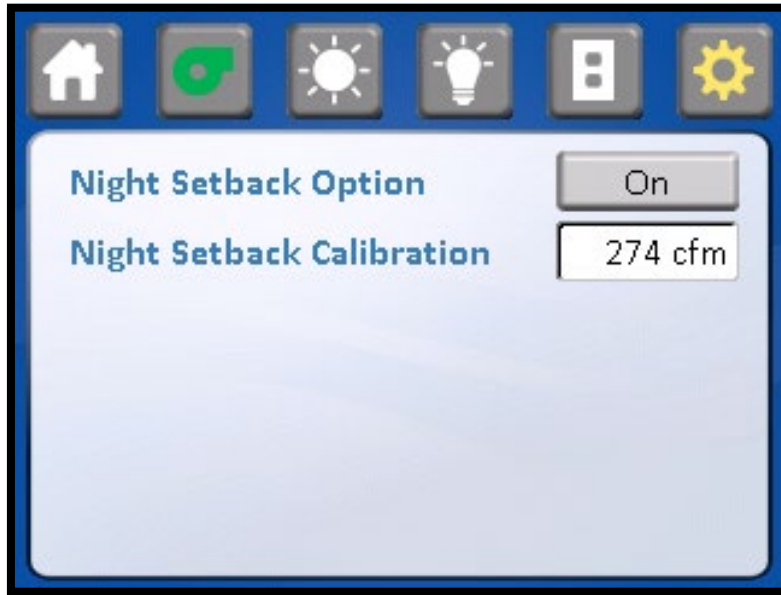

Step 2: Select CALIBRATE NIGHT SETBACK



Step 3: At this point, the night setback is active and the butterfly valve will begin to close. Now measure the inflow volume using a Direct Reading Instrument of inflow velocity measurement method. The goal is to reduce the inflow volume to the following values, which represents approximately 100 fpm (.51m/s) inflow, or may be set at any other values within the damper operational range of 30% to 80%.

NU-565-400	270 CFM/459 CMH
NU-565-600	410 CFM/697 CMH

Please note, in the night setback operation, the electronic airflow control system will cause the butterfly valve actuator to hunt more operating at lower airflow volumes. When taking the inflow volume measurements, average several readings to obtain the most accurate results.

7.6 HEPA Filter Leak Test

In order to check filter and filter seal integrity, the HEPA filter media and seals must be directly accessible, by the measuring instrument. The challenge material (i.e. PAO) should be supplied over the supply inlet for the supply filter and in the rear center of the workzone over the intake slots for the exhaust filter. The upstream challenge port for each filter is located on top of the cabinet.

7.6.1 Supply Filter

The diffuser plate placed below the HEPA to protect the filter during normal usage may be removed as follows: The diffuser is secured to the cabinet shell by #1/4-20 acorn nuts located immediately behind the front viewing window. After removing the fasteners, drop the front of the diffuser plate several inches and pull forward gently. Note that the diffuser is purposely a tight fit - it is held to the back wall of the cabinet interior by a light push - fit with projecting studs.

7.6.2 Exhaust Filter

The exhaust filter is checked using a gross leak method, since the exhaust filter is not easily scanned when connected to an exhaust system. It may be leak tested by drilling a hole in the duct at a downstream location that will produce a well-mixed aerosol and inserting the sampling probe with rigid extension tubing through hole.

 **NOTE:** To avoid the window high alarm during the filter integrity check, it is desirable to enter into the calibration/Service/sensor setup/calibrate downflow sensor menu.

 **NOTE:** If the upstream challenge port is deemed contaminated and not accessible, use both downflow and exhaust volume for determining challenge concentrations. Use following area information below with average downflow velocity and spot-check exhaust velocities as measured to determine volume (CFM) (CMH). Use exhaust volume as given.

<u>Model Size</u>	<u>*Supply Area (ft²)(m²)</u>	<u>Exhaust Volume CFM (CMH)</u>
400	7.81(.725)	740 (1257)
600	11.85 (1.101)	1122 (1906)

* Measured 4 inches (102mm) above the bottom edge of the window.

Laskin Nozzle Concentration Formula

$$\frac{\# \text{ Nozzles} \times 135 \text{ CFM} \times 100 \text{ ug/L}}{\text{Downflow (CFM)} + \text{Exhaust (CFM)}} = \text{Challenge Concentration (ug/L)}$$

$$\frac{\# \text{ Nozzles} \times 229 \text{ CMH} \times 100 \text{ ug/L}}{\text{Downflow (CMH)} + \text{Exhaust (CMH)}} = \text{Challenge Concentration (ug/L)}$$

7.7 Airflow Smoke Pattern Test

The airflow smoke pattern test is performed using a smoke source (i.e. smoke tubes) in and around the cabinet workzone and access opening to determine a visual representation of the cabinet's containment performance. To perform the test, the smoke source should be passed through the following areas:

1. A smoke source shall be passed from one end of the cabinet to the other, along the center line of the work surface, at a height of 4 inches (102mm) above the top of the access opening.
2. A smoke source shall be passed from one end of the cabinet to the other, 1 inch (25mm) just inside the view screen, at a height 6 inches (152mm) above the top of the access opening.
3. Pass a smoke source along the edges of the entire perimeter of the work opening approximately 1.5 inches (38mm) outside the cabinet, with particular attention paid to corners and vertical edges.
4. Pass a smoke source 2 inches (51mm) from the sides up inside of the window at the side channel seals, and along inside of the cabinet along the top of the work area or immediately below the wiper gasket.

The criteria used to evaluate the smoke patterns is the following:

1. The smoke inside the cabinet shall show smooth downward flow with no dead spots or reflux.
2. No smoke shall escape from inside the cabinet.
3. No smoke refluxes out of the cabinet once drawn in, nor does smoke billow over the worksurface or penetrate onto it.
4. No smoke shall escape from the cabinet.

7.8 Site Installation Assessment Tests

These tests are performed to verify the sash position, airflow or pressure setpoint where an audible and/or visual alarm will activate to signify unfavorable operating conditions within the Biosafety Fume Hood/Cabinet and/or the remote exhaust blower.

7.8.1 Sash Alarm

- Step 1: With sash alarm switch enabled, raise the sliding sash 1inch (2.5cm) above the manufacturer's designated sash height for normal operation. Verify that the audible/visual alarm activates/sounds.
- Step 2: Return the sash to its normal operating height.

7.8.2 Airflow or Pressure Alarm (Verified During Exhaust Airflow Calibration)

- Step 1: Using the primary or secondary inflow test method, lower the exhaust airflow to reduce the total flow by 20% from the certified testing value.
- Step 2: Verify that the alarm activates when the total flow has dropped to this point.
- Step 3: Adjust alarm setpoint as necessary.

7.9 Cleanliness Classification Test for Pharmacy Application

If this cabinet is going to be used within pharmacy, per USP797¹, the cabinet must be tested to assure compliance to ISO 14644-1:2015, Cleanrooms and Associated Controlled Environments, Part 1: Classification of Air Cleanliness². The cleanliness classification test is performed using a particle counter to measure particle counts within the cabinet workzone. Turn on cabinet and let warm up for several minutes. Turn on particle counter and flush out sample tubing line to remove latent particles. Set the particle counter to measure 0.5 micron or larger particles at the appropriate measuring rate.

“Operational Particle Count Test”³

Position the particle counter isokinetic probe at a point 6 inches (152mm) upstream of the aseptic manipulation area (hand convergence point) and mounted so as not to interfere with the operator’s hand movement. The pharmacy operator will simulate IV manipulation during the particle count test using non-hazardous materials. A minimum of three (3) 1-minute particle counts shall be sampled and recorded while the user simulates aseptic compounding manipulations.

“At Rest Particle Count Test”

Take 5 test points in 1-minute intervals on a grid, in a horizontal plane as measured approximately 6 inches (152mm) above the worksurface. The grid location is designed as the workzone center point and each corner measured 6 inches (152mm) from the inside perimeter.

Record the 5 particle count values for each of the test points over the 1-minute sample time. All final count particle concentrations and calculated 95% upper confidence limit shall not exceed 3520 particles per cubic meter (ppcm) or (100 particles per cubic feet (ppcf)).

¹ USP28-NF23: United States Pharmacopeial Convention, Inc., 12601 Twinbrook Parkway, Rockville, MD 20852, USA, www.usp.org.

² ISO 14644-1:2015 Cleanrooms and Associated Controlled Environments-Classification of Air Cleanliness, International Organization for Standardization, Case Postale 56, CH-1211 Geneve 20, Switzerland

³ CAG-002-2006: CETA Compounding Isolator Testing Guide, Controlled Environment Testing Association, 1500 Sunday Drive, Suite 102, Raleigh, NC 27607, USA, www.cetainternational.org

Table 7.0
Recommended Measurement Methods for Cabinet Downflow & Inflow

A. Downflow Measurement

- a. Instruments: TSI 8355 Thermo anemometer
- b. Procedure: Supply filter efflux is measured on a grid, in a horizontal plane defined by 4 inches (102mm) above the bottom edge of the window. No reading should be taken closer than 6 inches (152mm) from the inside perimeter.
- c. Test Data - Inches (mm):

Model Size Window Access Height									
400		7.0 (178)	12.396 (315)	17.792 (452)	23.188 (589)	28.584 (726)	33.980 (863)	39.375 (1000)	
	600	7.5 (191)	15.410 (391)	23.320 (592)	31.230 (793)	39.140 (994)	47.050 (1195)	54.960 (1396)	62.870 (1597)
7.0 (178)	7.5 (191)								
12.5 (318)	12.5 (318)								
18.0 (457)	17.5 (445)								

Number of Readings:	Average Velocity	ft./min.(m/s)
---------------------	------------------	---------------

- d. Acceptance Criteria:
 - 1. Average downflow velocity = **55 to 65 fpm (.28 to .33 m/s)**
 - 2. Individual readings must be within $\pm 20\%$ or $\pm 16\text{fpm}$ ($\pm 0.08\text{m/s}$) whichever is greater (factory test) or $\pm 25\%$ or $\pm 16\text{fpm}$ ($\pm 0.08\text{m/s}$) whichever is greater (field test) from the average downflow velocity.

B. Inflow/Exhaust Volume Measurement

- a. Instrument: Shortridge Flowhood ADM-870 or TSI 8355 Thermo anemometer.
- b. Procedure: The exhaust airflow (customer supplied) shall draw air from the cabinet. Any one of a number of airflow controlling and measuring means may be used to establish inflow/exhaust volume. The inflow/exhaust volume is established for the cabinet having the workzone downflow average velocity at its nominal value. To measure the inflow volume, the internal blower should be turned on, thus, the inflow volume balanced with the downflow volume can be measured to set the desired average inflow velocity.

The inflow/exhaust volume is measured by using a Direct Inflow Measurement (DIM) instrument (i.e. Shortridge Flowhood). The DIM instrument can be used directly on the cabinet with **NO CORRECTION FACTORS REQUIRED**. The DIM instrument should also be duct taped to the cabinet's front work access opening to prevent any sneak air paths from occurring. The DIM instrument will read inflow volume (i.e. CFM). Use the area table to calculate the inflow velocity and referenced exhaust volume (Certification values listed in Table 7.1) based upon the DIM measurement.

Alternate Procedure:

The alternate procedure to determine inflow velocity uses a thermo anemometer in a constricted window access opening of 3 inches (76mm) with the downflow blower on and the armrest removed. Inflow air velocity is measured in the center of the constricted opening 1-1/2 inches (38mm) above the work access opening on the following specified grid. Use the area correction factor table to calculate the inflow velocity and reference exhaust volume. (Certification values listed in Table 7.1)

 **NOTE:** Since Nuair cabinets use a full supply diffuser, resulting in uniform airflow velocities, Nuair has found that the average supply velocity and the average downflow velocity are typically found to be the same value or can be related with a small correction factor. Using the average downflow velocity or a corrected average downflow velocity (see individual model numbers below) to calculate the supply volume if desired to evaluate cabinet airflow value.

I.E. NU-565-400
 Average downflow velocity = 60 fpm
 Average supply volume velocity = 60 fpm
 Supply volume = 60 x 7.81 = 469 CFM

I.E. NU-565-600
 Average downflow velocity = 60 fpm
 Average supply volume velocity = 60 fpm
 Supply volume 60 x 11.85 = 711 CFM

c. Test Data – Inches (mm):

1. DIM Measurement

Inflow Volume	ft. ³ /min. (m ³ /s)	÷ Access Opening Area	ft. ² (m ²)	= Inflow Velocity	ft./min (m/s)
Inflow Volume	ft. ³ /min. (m ³ /s)	+ Supply Volume	ft. ³ /min. (m ³ /s)	= Total Exhaust Volume	ft. ³ /min. (m ³ /s)

2. Constricted 3 inch (76mm) high access opening measurement - Inches (mm):

40	4	8.26	12.52	16.79	21.05	25.32	29.58	33.84	38.11	42.37						
0	(102)	(210)	(318)	(426)	(535)	(643)	(751)	(860)	(968)	(1076)						
60	4	8.15	12.31	16.47	20.63	24.79	28.94	33.10	37.26	41.42	45.58	49.73	53.89	58.05	62.21	66.37
0	(102)	(207)	(313)	(418)	(524)	(630)	(735)	(841)	(946)	(1052)	(1158)	(1263)	(1369)	(1475)	(1580)	(1686)

Number of Readings:	Average Velocity of Constricted Area	ft./min. (mps)
---------------------	--------------------------------------	----------------

1.		Average Velocity of Constricted Area	fpm (m/s)
2.	X	Constricted Access Area	ft ² (m ²)
3.	=	Constricted Area Volume	CFM(m ³ /s)
4.		Constricted Area Volume	CFM(m ³ /s)
5.	÷	8" (203mm) Access Window Area	ft ² (m ²)
6.	=	Average Velocity of 8" (203mm) Access Window Area	fpm (m/s)
7.		Average Velocity of 8" (203mm) Access Window Area	fpm (m/s)
8.	X	Correction Factor for 8" (203mm) Window	
9.	=	Average Inflow Velocity	fpm (m/s)
10.		Average Inflow Velocity	fpm (mps)
	X	Access Opening Area	ft ² (m ²)
	=	Inflow Volume	ft ³ /min.(m ³ /s)
11.		Inflow Volume	ft ³ /min.(m ³ /s)
	+	Supply Volume	ft ³ /min.(m ³ /s)
	=	Total Exhaust Volume	ft ³ /min.(m ³ /s)

d. Acceptance Criteria: Access opening inflow velocity = 100 to 110 fpm (.51 to .56 m/s)

Areas/Correction Factors for Calculations

Cab. Size	3" (76mm) Constricted Window Access Area ft², (m²)	8" (203mm) Window Access Opening Area ft², (m²)	Correction Factor for 8" (203mm) Window	Work Zone Area ft², (m²)
400	.97 (.090)	2.58 (.239)	.97	7.81 (.781)
600	1.47 (.137)	3.91 (.363)	.98	11.85 (1.101)

**Table 7.1
Certification Values**

The following are recommended minimum/maximum cabinet airflow certification setpoints per NSF/ANSI 49. Nuair recommends, however, operation at the stated average flow, for ease of maintenance and annual certification.

THE FOLLOWING EXHAUST FLOWS ARE FOR AN 8 INCH (203MM) WORK ACCESS OPENING:

Parameter	Minimum Acceptable Flow	Stated Nominal Average Flow	Maximum Acceptable Flow
NU-565-400			
1. Inflow Avg. Velocity	100 (.51 m/s) FPM	105 (.53 m/s) FPM	110 (.56 m/s) FPM
2. Inflow Volume	258 (438 CMH) CFM	271 (460 CMH) CFM	284 (483 CMH) CFM
3. Supply Avg. Velocity	55 (.27 m/s) FPM	60 (.30 m/s) FPM	65 (.33 m/s) FPM
4. Supply Volume	430 (731 CMH) CFM	469 (797 CMH) CFM	508 (863 CMH) CFM
5. Total Volume	688 (1169 CMH) CFM	740 (1257 CMH) CFM	792 (1346 CMH) CFM
NU-565-600			
1. Inflow Avg. Velocity	100 (.51 m/s) FPM	105 (.53 m/s) FPM	110 (.56 m/s) FPM
2. Inflow Volume	391 (664 CMH) CFM	411(698 CMH) CFM	430 (731 CMH) CFM
3. Supply Avg. Velocity	55 (.27 m/s) FPM	60 (.30 m/s) FPM	65 (.33 m/s) FPM
4. Supply Volume	652 (1108 CMH) CFM	711 (1208 CMH) CFM	770 (1308 CMH) CFM
5. Total Volume	1043 (1772 CMH) CFM	1122 (1906 CMH) CFM	1200 (2039 CMH) CFM

 **NOTE: 1:** Nuair recommends the cabinet be set up and certified at the stated **nominal average inflow**.

EXAMPLE:

NU-565-400 Inflow Volume Measurement / Calibration

- 1) Inflow volume measured with DIM at cabinet face with blower on and downflow velocity approximately at 60 fpm (.30 m/s), inflow volume = 271cfm (460 CMH).
- 2) Inflow volume + supply volume = exhaust volume
271cfm (460CMH) + 469cfm (797CMH) = 740cfm (1257CMH)
- 3) So, based on the inflow measurement volume and adding the supply volume from the table for the nominal average velocity, the calibrated exhaust value entered should be 740cfm (1257CMH).

NOTE: 2: For additional guidance, the values provided below with a constant 60fpm (.30mls) downflow velocity can be used for exhaust adjustment.

NU-565-400		
Inflow Volume	Inflow Velocity	Exhaust Volume
258	100	727
263	102	732
268	104	737
271	105	740
274	106	743
279	108	748

NU-565-600		
Inflow Volume	Inflow Velocity	Exhaust Volume
391	100	1102
399	102	1110
407	104	1118
411	105	1122
415	106	1126
422	108	1133

7.10 Main Control Board Description & Replacement

To access the main control board for fuse or board replacement, remove screws at each upper side of the control center and allow the control center to rotate down, resting on the safety straps. Now the main control board is exposed for service.

7.10.1 Main Control Board Replacement

The main control board consists of two interconnected Printed Circuit Board (PCB) assemblies. The front PCB contains the LCD display. The back PCB contains the power supply, sensor inputs/outputs and control inputs/outputs components. The mechanical and electrical interconnects for the two PCB's all occur within the assemblies and are fastened together with standoffs and screws.

7.10.2 Main Control Board Fuse Replacement



Disconnect electrical power from cabinet before fuse replacement.

All AC circuits are fuse protected and when replacement is necessary, **USE ONLY FUSES OF SAME TYPE AND RATING FOR PROTECTION AGAINST RISK OF FIRE.**

DESCRIPTION:	BLOWER FUSE	OUTLET FUSE	LIGHT FUSE
FUSE TYPE:	TIME-LAG	TIME-LAG	TIME-LAG
FUSE SIZE:	1/4 X 1-1/4 INCH	5 X 20MM	5 X 20MM
NU-565-400	10 AMPS	3 AMPS	1 AMP
NU-565-600	10 AMPS	3 AMPS	1 AMP

7.10.3 Main Control Board Replacement

Note: All setup and calibration data will be lost, the memory reinitialized to the default values and all control functions reset to an initial cabinet power condition. If possible, before the main control board replacement, it would be preferred to know the operational parameters of the cabinet, (i.e. motor/blower voltage, setpoints, and airflow data from previous certification.

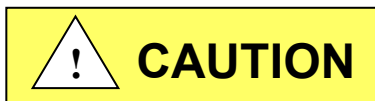

Disconnect electrical power from the cabinet before attempting any maintenance action.

The main control board is fastened to the control center with (6) 6-32 screws. All electrical connections are made with removable terminals and/or Faston connectors except for the motor/blower connector which uses a screw terminal. Remove all electrical connections and fasteners then remove the main control board from the control center.

Install new main control board by reattaching all electrical connections and fasteners. Once installed, rotate control center to normal position and fasten in place.

Now reconnect power to cabinet. Upon BSCC system power up, a system MASTER RESET must be performed to clear the microprocessors non-volatile memory to assure proper system function.

7.10.4 Cabinet Reset

The main control board has two software operating resets available for qualified service personnel. The two types are the following:

Factory Reset - Resets setpoints and selected option settings. Factory reset should be used in the event the system memory develops an error in operation. Cabinet type, motor type and calibration data will not be affected with this reset.

Master Reset - Resets all calibration, cabinet type, motor type, sensor data, and options settings back to default settings. Master Reset should only need to be used for a main control board replacement.

After pressing the Calibration/Service menu item, a password screen will appear. The default password is "9876". Once the service password is entered, the Calibration/Service menu will appear.



Select CABINET RESET from the menu.



- Select desired function from menu.

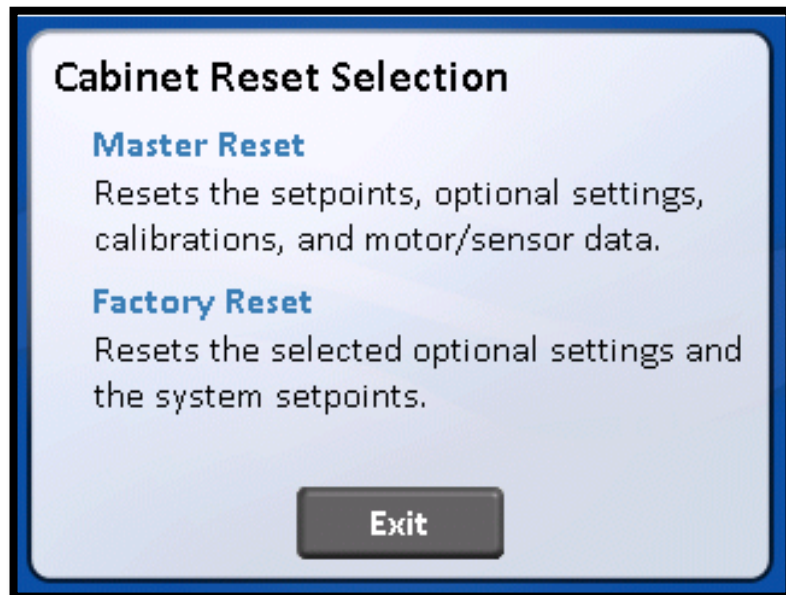

- Perform either reset function as selected below.



- Once factory reset is complete, return to Calibration/Service menu to enter any options.



Once the MASTER RESET icon is pressed, the display screen will remain the same for approximately a few seconds. Once the reset process is complete the display screen will revert back to the Nuair logo main menu. At this point the cabinet MUST be turned off to complete the process. Either unplug the cabinet or use the power switch within the control center to turn off the cabinet. Turn the cabinet back on the display screen will remain blank for up to a minute, then will indicate "Power Loss Alert", press the screen to clear the message and return to the Calibration/Service menu to enter cabinet type and perform airflow calibration.

7.11 Digital Airflow Sensor Description & Replacement

7.11.1 Downflow Velocity Sensor

The airflow sensor function utilizes two thermistors that provide a constant current source. One thermistor is a reference that uses a very low current source. The other thermistor is the airflow measurer that uses a very high current source. As airflow passes over the thermistors, the airflow removes heat from the thermistor measuring airflow. The loss of heat from the thermistor causes the voltage from the thermistor to increase. This increase subtracted from the reference thermistor output voltage is what directly relates to airflow velocity. A repeatable curve can be generated (voltage vs. airflow velocity).

The thermistors used are glass bead and coated and can be cleaned by gently using a cotton swab and alcohol. Formaldehyde gas, Hydrogen Peroxide and Chlorine Dioxide has no effect on the airflow sensors; however, the formaldehyde/Ammonium bicarbonate residue that remains after decontamination should be removed from the airflow sensor thermistors.

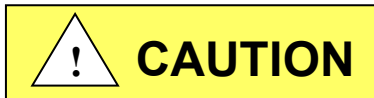

Disconnect electrical power from the cabinet before attempting any maintenance action.

The airflow sensor is removed by turning the locking ring counterclockwise and gently pulling the sensor away from the connector. To reattach the airflow sensor, turn sensor in keyed connector until key matches, push in and turn the locking ring clockwise until ring locks. Proceed to calibrate sensor menu.

7.11.2 Exhaust Pressure Sensor

The exhaust pressure sensor is a digital differential velocity pressure flow grid. The exhaust pressure sensor board is located within the right side of the control center.

The exhaust pressure sensor function utilizes a differential pressure transducer and electronic temperature sensor to measure exhaust volume. A flow grid mounted in the exhaust airflow stream provides a velocity and static pressure to the differential pressure transducer. An equation using the pressure drop across the flow grid along with the temperature reading provides a volumetric flow reading. The volumetric flow reading is then calculated by the duct area to provide the displayed exhaust volume.

The flow grid located in the exhaust airstream is made from PVC and is not affected by Formaldehyde, Hydrogen Peroxide or Chlorine Dioxide.



Disconnect electrical power from the cabinet before attempting any maintenance action.

The exhaust pressure sensor board is removed by unfastening (2) 6/32 nuts and removing the connectors and tubing then gently pulling up the board until free. To reattach, reverse the above procedure. The exhaust sensor also has an onboard LED indicator that indicates a properly operating sensor. The LED DS1 blinks in slow 1 second intervals during normal operation. It will blink faster or full on when a sensor error occurs at which time the sensor board needs to be replaced. Proceed to calibrate sensor menu.

8.0 Error Messages, Troubleshooting, Option-Diagnostics & Airflow Sensor Performance Verification

Audible alarms and error messages occur for a variety of reasons. Whenever an alarm condition has been present for a period of at least 10 seconds, the audible alarm/error message will be presented and stay on until the error is cleared. The audible alarm will be on for 30 seconds upon initial alarm condition, then once every ten seconds. When presented with an error message, please perform the following:

Step 1: NOTE ALL ERROR MESSAGES.

Error message will appear in place of the Nuair logo with "Active Alarms" and the alarm type below.

Step 2: VERIFY ERROR MESSAGES.

Error messages can be verified by cleaning the error function by either turning the blower or the cabinet on and off.

Step 3: MONITOR RE-OCCURRENCE OF ERROR MESSAGES.

If re-occurrence of the error message is immediate or daily, use guide below to correct the situation.

8.1 Error Message Troubleshooting Guide

Error Message	Indicator	Correction
– Window Alarm (Window High)	Sliding window is above its standard working height or micro switch is not operating properly.	Verify standard working height and window micro switch operation.
– Airflow Alarm – Red Downflow Arrow (Downflow Low Limit)	Downflow airflow fell below its lower limit alarm setpoint.	Re-certify cabinet to proper airflow setpoints.
– Airflow Alarm – Red Downflow Arrow (Downflow High Limit)	Downflow airflow went above its high alarm setpoint.	Re-certify cabinet to proper airflow setpoints.
– Airflow Alarm – Red Inflow Arrow (Inflow Low Limit)	Inflow airflow fell below its lower limit alarm setpoint.	Check orientation of exhaust sensor shroud. Re-certify cabinet to proper airflow setpoints.
– Airflow Alarm – Red Inflow Arrow (Inflow High Limit)	Inflow Airflow went above its high alarm setpoint.	Check orientation of exhaust sensor shroud. Re-certify cabinet to proper airflow setpoints.
– Low Pressure Alarm (Low pressure Limit)	Indicates low pressure or low cabinet airflow	Re-certify cabinet to proper airflow setpoints.
Cabinet fluorescent lights won't turn on.		Check light fuse on main control board. Check fluorescent lamps. Check voltage coming out of main control board to light ballasts. Check light starters, if present. Check ballast.
Cabinet Blower won't Turn On.		Check blower fuse on main control board. Check voltage coming out of main control board. Check wiring to blower. Check blower motor. (Note: blower motor has internal thermal protector. Let blower motor cool off for a minimum of 30 minutes to assure thermal protector is not open).
Display indicates (Remote Override Active)	Indicates that the remote override is activated, preventing the usage of the cabinet.	
Power Loss Alert!	Indicates a power interruption has occurred.	Press DISPLAY to clear message.
Cabinet outlets won't turn on.		Check outlet fuse located on main control board. Check voltage coming out of main control board.
Cabinet ultraviolet light won't turn on.		Check sliding window position so that it's fully closed. Check blower/lights fuse on main control board. Check voltage coming out of the main control board to ultraviolet light ballast. Check light starters, if present. Check ballast.
Blower or light fuse continues to blow after replacement.		Check for short on output of fuse. Isolate output of fuse by disconnecting light circuit, blower circuit, etc. to isolate short.
Replace UV Light!	Indicates that the UV light needs replacement	Replace UV light and clear UV run time clock.
Display indicates (Night Setback Active)	Indicates that the night setback is activated, preventing the usage of the cabinet.	
Certification due in X weeks.	Indicates the need to schedule the cabinet certification based on the scheduled timetable programmed.	Message will clear once the certifier updates the current certification date.
Active Alarms DN Sensor Comm! EX Sensor Comm!	Indicates a digital communications error from the main control board to the airflow sensors.	Check connectors and wires from main control board to the airflow sensors. DN indicated downflow sensor. EX indicates exhaust sensor.
Active Alarms DN Sensor Error! EX Sensor Error!	Indicates an error signal generated by the sensor.	Check airflow probe connector on main board. (Ref. Section 7.11). Replace airflow sensor if required.
Touch Link Display User Interface	Touch area's of display do not Align w/ icons	Calibrate display in adjust display brightness screen
Run Time Failure	Indicates a temporary microprocessor issue	Clean alarm a see it reoccurs, check line voltage to control board, replace control board

Error Message	Indicator	Correction
Recertification Due/ Past Due		Reset certification date in calibration /service menu
Blank Display Audible / Visual Alarms Active	Microprocessor Failure	Cycle cabinet power OFF/ON Replace control board

8.2 Calibration/Service Menu

8.2.1 General

As with the airflow calibration process, the service menu should only be accessed by a Service Technician that is familiar with the product. Press MENU to access Calibration/Service parameter.



Entry into the Calibration/Service functions requires a service password for entry. After pressing the Calibration/Service menu item, a password screen will appear. The default password is "9876". Once the service password is entered, the Calibration/Service menu will appear.

As a special feature for the service technician, by accessing the Calibration/Service menu, the service technician can bypass the blower warm up time itself. This feature remains on for one hour from the time the Calibration/Service menu was accessed. When bypassing the warm up time, it is not uncommon to experience a brief alarm as the blower stabilizes at setpoint.



8.2.2 Calibration/Service Menu

The Calibration/Service menu provides a list of sub-menu items to accomplish all service tasks. Each sub-menu item will be described in the following sections.



8.2.2.1 Blower/Damper Setup

Blower Options

The blower options menu allows **A QUALIFIED TECHNICIAN** to run the cabinet in manual mode. This means with no controls or alarms activated. Manual Blower control: When the manual blower control is on, the downflow and inflow displays will indicate



Manual Blower Control

This parameter allows **ONLY THE CABINET TECHNICIAN** to run the cabinet in manual mode. This means with no controls or alarms activated. When the manual control is on, the downflow and inflow displays will indicate nominal setpoints. Airflow adjustments can be made in the manual mode by going into airflow calibration and adjusting the blower duty cycle. The blower duty cycle will remain constant in manual mode. The display will also indicate the manual control is activated. When the manual control is off, full automatic control resumes.

- **Blower Lockout**

This parameter allows the access to turn the blower on or off to be restricted by the use of a password. When the blower lockout is on, pressing the blower icon will produce a numerical password screen. When the blower lockout is off, the blower may be turned on and off without restriction.

- **Password Reset**

The default password is “1234” and may be changed using the password reset.



Night Setback Calibration (see calibration section)

The night set back calibration is performed within the calibration mode after the inflow and downflow calibration procedure is complete.

Exhaust Damper Set up

Exhaust Airflow Control

This parameter allows for the selection of time, programmable from 30 to 240 seconds determining how often the exhaust controller updates the control signal to the automatic damper (i.e. NU-951-012) if installed. Reducing the time will cause the damper to react quicker to change but may result in control Overshoot and oscillations. Increasing the time will cause the damper to react slower to changes but may not keep up with normal systems fluctuations. Depending upon the HVAC system, changing this parameter allows control flexibility for exhaust system optimization.



Exhaust Damper Position

This parameter allows for the selection to disable the exhaust control/alarm and select a desired damper position when the blower is turned off. Normally when the blower is turned off the exhaust control and alarm function remains active in the B1/B2 configuration. However, if the cabinet is tied into the exhaust blower circuit it is desirable to turn off the exhaust control and alarm function when the blower switch is turned off. This will avoid having a constant exhaust alarm when the exhaust system is turned off. Valid settings for the exhaust control damper position are open, close, freeze, or off. Off keeps the exhaust control/alarms active when the blower is off.



Exhaust Override

(CAUTION: THIS PARAMETER SHOULD ALWAYS BE TURNED OFF FOR SAFE FUNTION OF A TYPE B2 CABINET.)

This parameter allows for the selection to override the controller blower interlock for testing purposes. When exhaust override is off, sufficient exhaust airflow is required for the internal blower to function. When on the internal blower will function without sufficient exhaust.

 **Note:** The redundant pressure switch must also be bypassed for the internal blower to run without exhaust.



Remote Override Damper Open

This parameter allows or the NU-951 damper to open during a remote override contact closure. Normally the NU-951 damper function will close during a remote override contact closure. However, this option allows the opposite damper functio



8.2.2.2 Service

The service setup menu allows a QUALIFIED TECHNICIAN to configure, calibrate and obtain functional service data. Each parameter submenu will be described as well as the display will indicate present and/or default conditions as shown.



Run Times

This parameter allows the service technician to view, alter, or reset both UV light and motor blower run timer.

- Select desired run time parameter from menu.
- UV Run Time. Quantity of hours the UV light has logged ON. Reset time for UV lamp replacement.

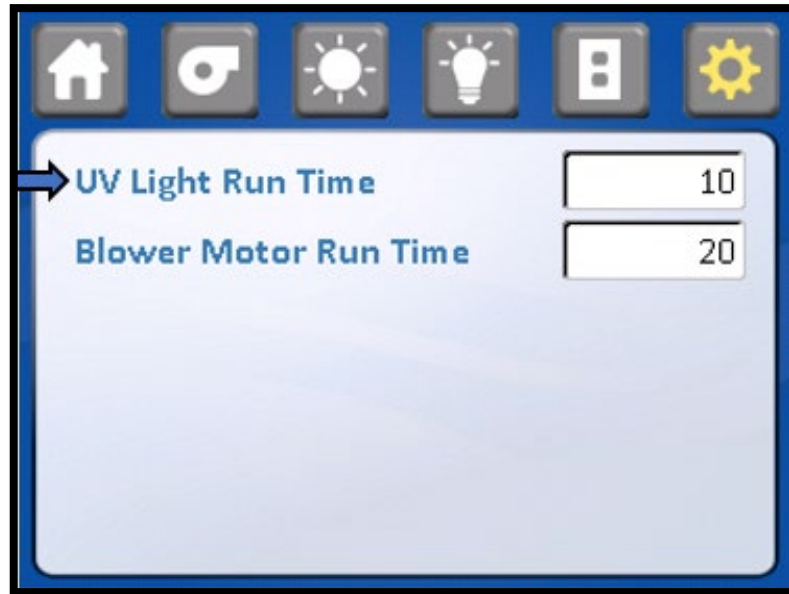

- Motor Blower Run Time: Indicates how many hours the blower has been ON. Time may be reset or transferred for service purposes.



Certification Date

This parameter allows the service technician to view and update the current certification date. The certification date also has a feature to indicate an advance notice that re-certification is due. Press DUE to enter into the certification required time period screen. Select desired interval of certification required, i.e. No Reminder, 6, 12, 18, or 24 months. The reminder will appear during the warm up cycle for 10 seconds every time the blower is turned on starting 4 weeks before the due date, then past due.

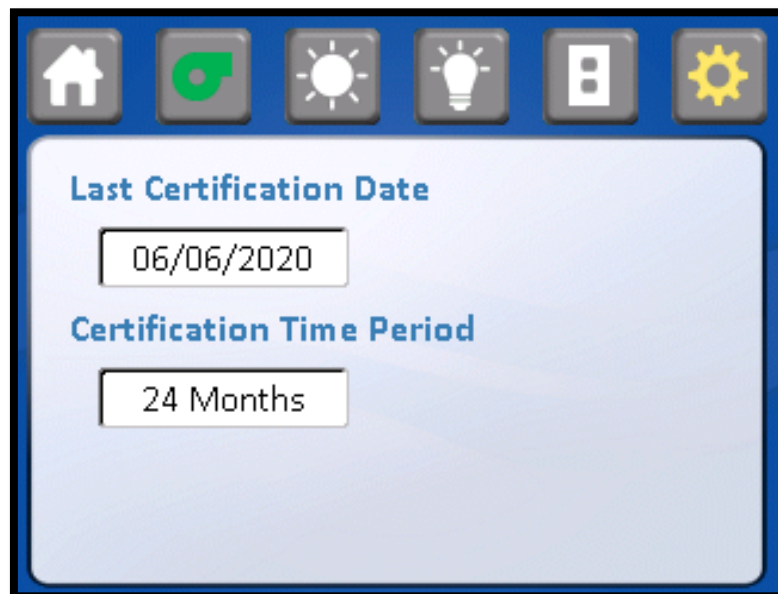

Last Certification Date

05 / 28 / 2020

1	2	3
4	5	6
7	8	9
CLR	0	←

Cancel Enter

Certification Time Period

- No Reminder
- 6 Months
- 12 Months
- 18 Months
- 24 Months

Back Select

Filter Status Data

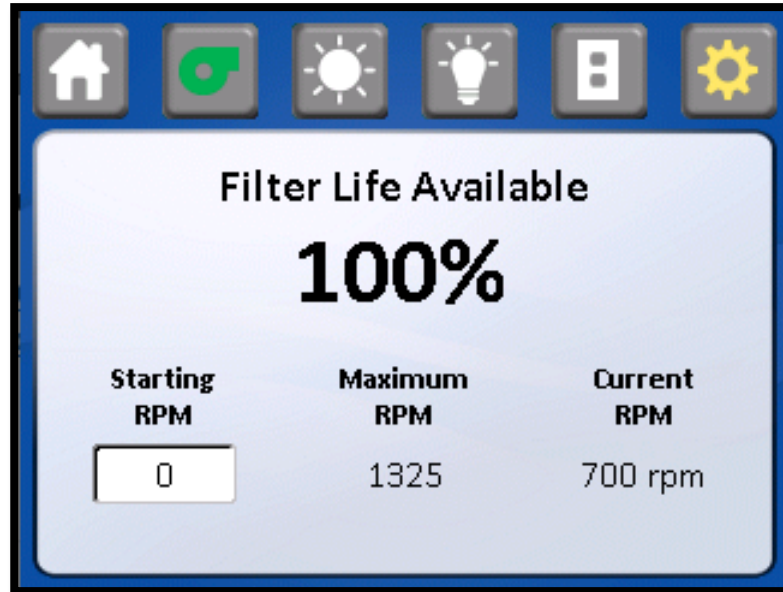

This parameter allows the service technician to set the filter status data used to predict filter life availability. Filter status is based on maximum RPM minus the starting RPM (entered by technician) then scaled to current RPM to determine filter percentage availability. Starting RPM data may be entered at any time for service purposes.

Factory Setup:

The screenshot shows a control panel interface with a blue border and a light blue background. The title "Factory Setup" is at the top left in bold black font. Below it, there are four rows of settings:

Model Number	B2 NU-560/565-300
Serial Number	000000000000
Language	English
Motor System	DC ECM Single

At the bottom of the screen, there are two buttons: a grey "Exit" button and a green "Save" button.

8.2.2.3 Option Setup

The option set up menu allows **A QUALIFIED TECHNICIAN** to configure several different optional parameters per the menu below. Each parameter sub-menu will be described as well as the display will the default conditions as shown



- **Alarm Setup**

- **Alarm Silence:** This parameter allows for the selection of the alarm silence key function. When the alarm silence function is on, all current and future alarms will be silenced for the designated alarm silence time (i.e. default time is 15 minutes). When the alarm silence function is off, all current alarms will be silenced for the designated alarm silence time. If a new alarm is present, the audible alarm will again be turned on.

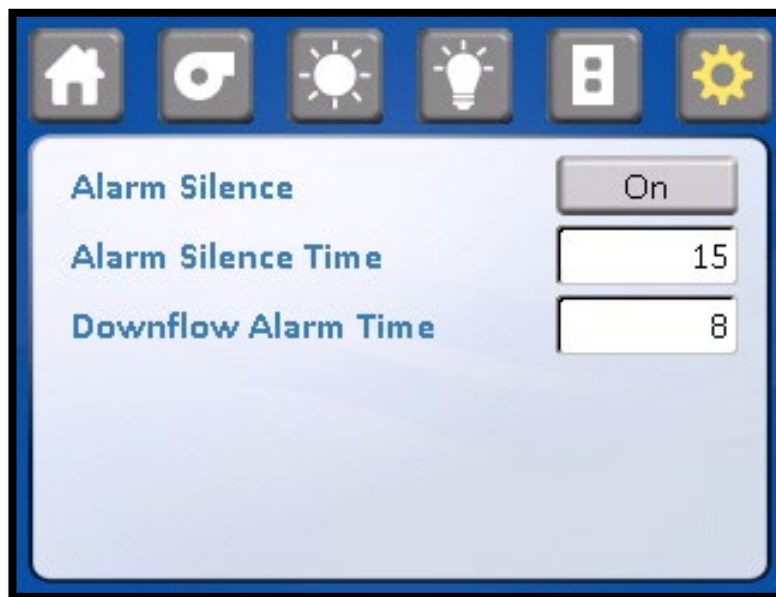

- **Alarm Silence Time:** This parameter allows for the selection of time to determine how long the audible alarm shall be silenced. The time is displayed in minutes with a programmable range of 1 to 60.

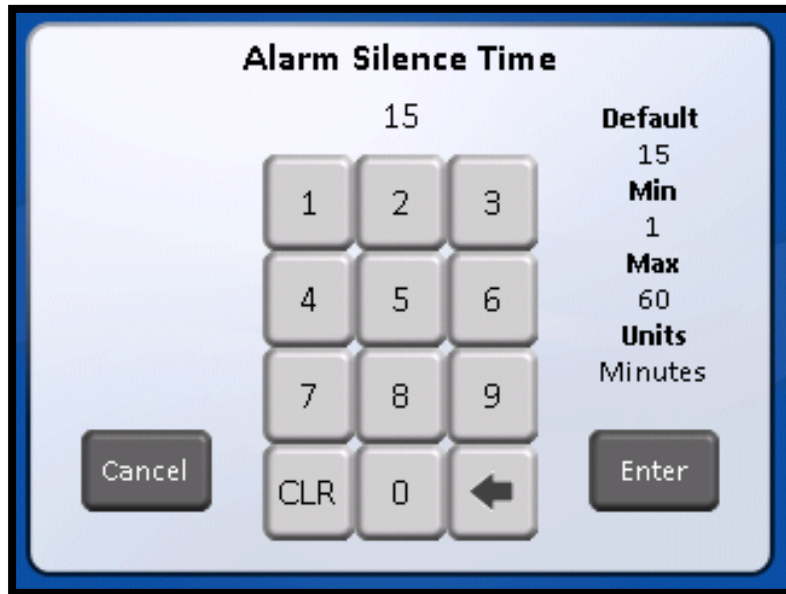

- **Downflow Alarm Time:** This parameter allows for the selection of time to determine how many continuous seconds of an alarm condition occurs before activating an audible and visual alarm. The time is displayed in seconds with a programmable range from 2 to 12 seconds.

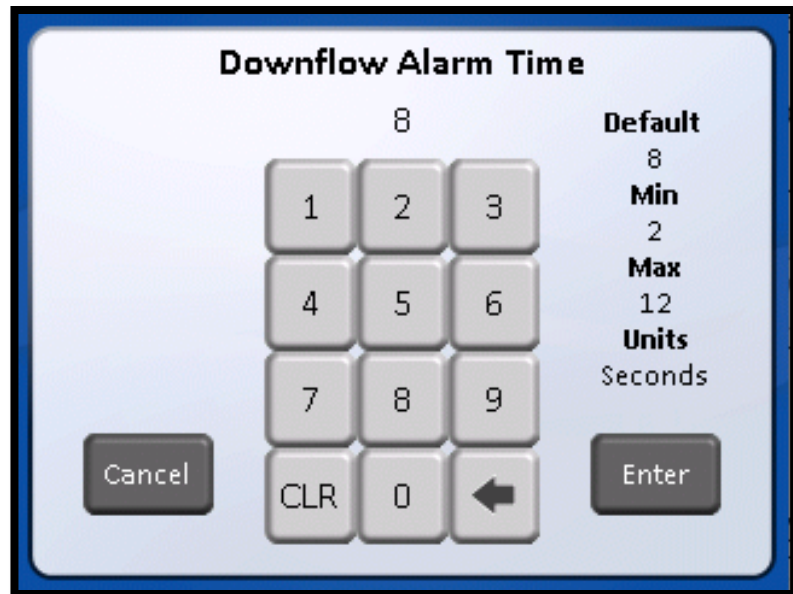

- **Interlock Features**

All interlocks are enable/disabled by a user through the display

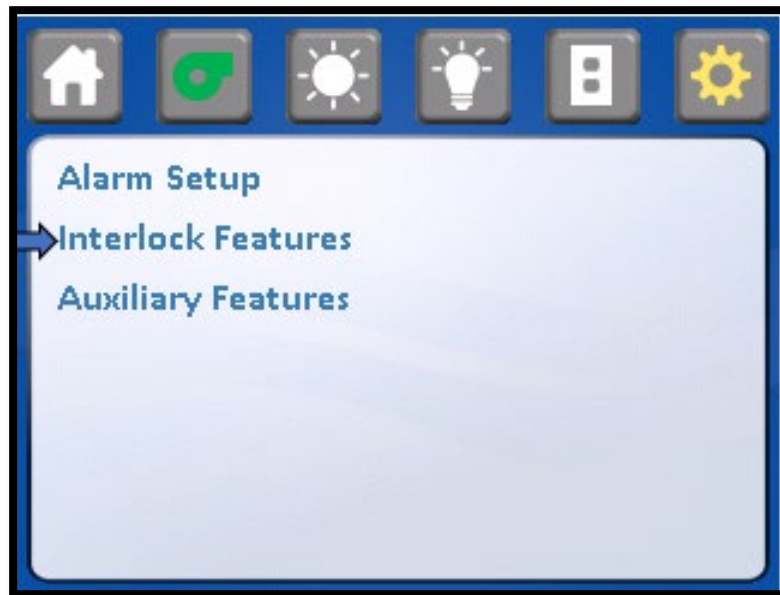

- **UV Window interlock:** This parameter allows for the selection of the window closed switch to be interlocked with the UV light option. When the window interlock is on, the window must be closed for the UV light to operate. When the window interlock is off the UV light can be turned on regardless of window position.



NOTE: In addition to the **TOUCHLINK** system UV window interlock there is a double redundant UV window interlock relay. To override the UV window interlock for service purposes only, both interlocks must be changed through the **TOUCHLINK** system and shorting the relay connection (see electrical schematic for reference).

- **Blower Window Interlock:** This parameter allows for the selection of the window closed switch to be interlocked to the blower. When the blower interlock is on, the blower will turn off when the window is closed. When the blower is off, the blower will continue to run when the window is closed

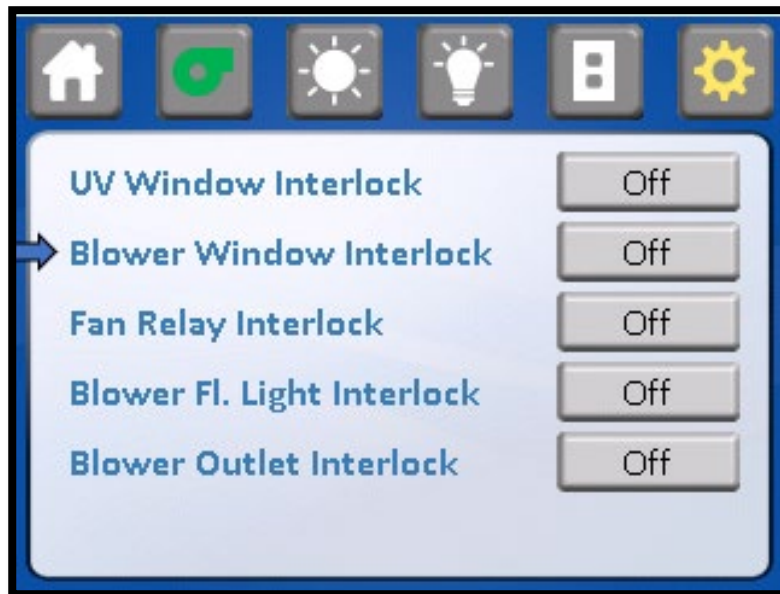

- **Fan Relay interlock:** This parameter allows for the selection of the fan relay interlock operation. When the fans relay interlock is on, and the blower switch is pending or blue, the fan relay will be off or not energized. If the fan relay interlock is off and the blower switch is pending or blue, the fan relay will be on or energized. In either case the fan relay will be on when the blower switch is on or green and off when the blower switch is off or not colored.



- **Blower FL Light Interlock:** This parameter allows for the selection of the FL light option to be interlocked to the blower. When the blower FL light interlock is on, the FL light operation will be interlocked to the blower. When the blower FL light interlock is off, the FL light can be turned on at any time.



- **Blower Outlet Interlock:** The blower/outlet interlock turns on/off the outlets whenever the blower is turned on/off. The outlet power can no longer be controlled manually



- **Auxiliary Features**

This menu item provides the access to aux relay function and accessory outlet functions



- **Aux Relay function:** This parameter allows for the selection of the AUX relay function. When the AUX relay is on, the AUX relay function will be identical to the fan relay. When the AUX relay function is off, the AUX relay function provides delay ON/OFF option.
- **Accessory Outlet:** this parameter allows to turn ON and OFF the accessory outlet.

8.2.2.4 Diagnostics

The diagnostics menu allows **A QUALIFIED TECHNICIAN** to exercise the control systems Blower /Sensor Diagnostics, window Diagnostics and General I/O Diagnostics Each of these has its own menu screen to excise the control system. Select menu screen as desired.



Blower/Sensor Diagnostics

Test outputs allow a service technician to exercise these output functions. Pressing TOGGLE will turn on and off the functions. Press UP and DOWN to select the test output desired. Use the display icons to turn on/off each function of blower, UV light, fluorescent light, outlet and optional power window if installed.

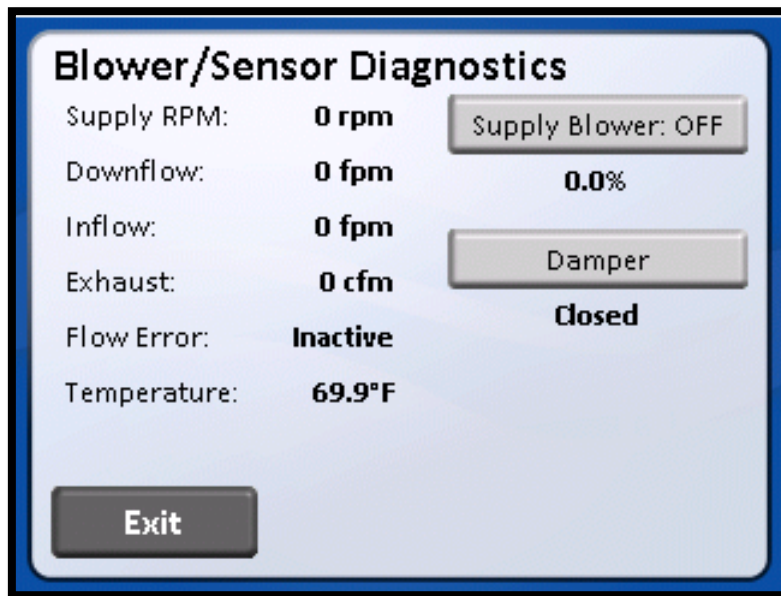

Window Diagnostic

Read inputs all a service technician to exercise or check these input functions. The inputs may be checked by altering the state of the input function (i.e. sliding window position) and monitoring the change on the display.

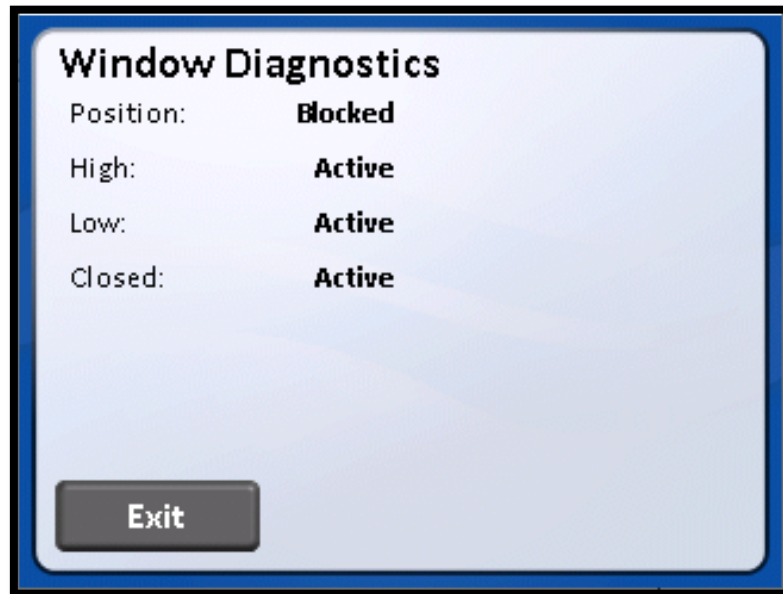

General I/O Diagnostics

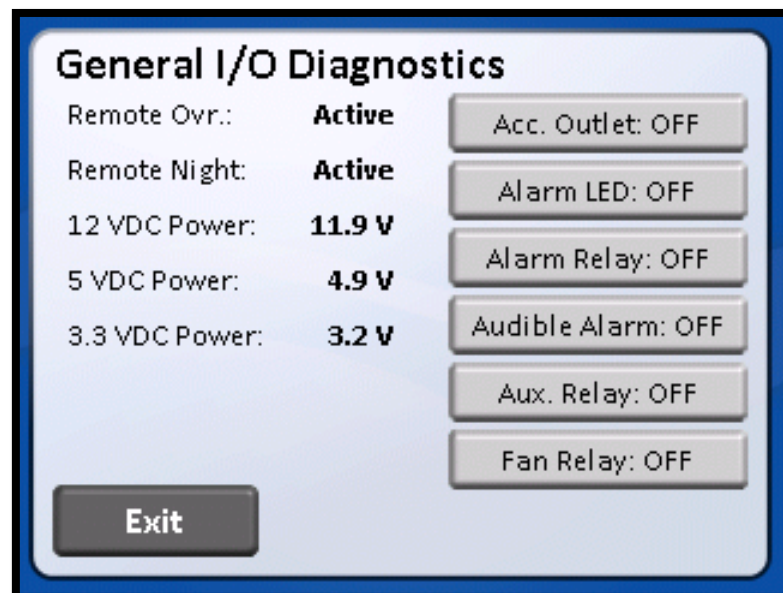

8.3 Airflow Sensor Performance Verification

The individual airflow sensors can be routinely checked during calibration or in diagnostics to assure they are reading and active within the range of use (0 to 200 fpm) (0 to 1.02 mps). The airflow sensors can also be checked in the run mode through performance verification, for responsiveness to changing airflow conditions.

8.3.1 Run Mode

To check the airflow sensor in run mode, first allow the cabinet to operate normally for a minimum of 5 minutes. Then, place a rolled piece of paper over the downflow sensor in the workzone and leave the paper on the sensor for at least 2 minutes and then remove. This action will cause the cabinet to go into a downflow alarm condition. The exhaust airflow reading should increase during this test. However, the downflow reading should go down below 25 fpm (.13 m/s). There should also be a noticeable increase in motor/blower noise. It would also be recommended to monitor motor/blower voltage during the test. The motor/blower voltage should be monitored from when the cabinet is running normally. During the test, when the downflow sensor is covered, the motor/blower voltage should be steadily increasing to slightly under line voltage. When the downflow sensor is uncovered, the motor/blower voltage should decrease and airflow readings should be within the calibration range.

If the motor/blower voltage does not change, an airflow sensor problem could exist. Please consult with Nuair Technical Service.

9.0 Remote Contacts

The NU-565 has several contact closures for remote sensing of various functions.

9.1 Fan Relay

The fan relay contacts are dual normally open contact closure outputs which are activated whenever the blower is turned on. Contact ratings are 250 VAC maximum at 2 Amps.

9.2 Alarm Relay

The alarm relay contacts are dual normally open contact closure outputs which are activated whenever an airflow alarm condition occurs. An airflow alarm condition will occur if either airflow sensor detects 5 consecutive 2 second airflow readings above or below the alarm limits. Contact ratings are 250 VAC maximum at 2 Amps.

9.3 AUX Relay

The AUX relay contacts are common, normally open and normally closed contact closure outputs which are activated whenever the blower is turned on. However, the AUX relay does have some conditional logic programmed to aid the supply On/Off and exhaust delay options. The relay will activate whenever the blower is turned on and stay on unless after 5 minutes there is a low exhaust alarm, then the relay will de-activate. If exhaust is sufficient, the relay will stay active. If the blower is then turned off, the relay will stay active for one minute, then de-activate. The AUX relay may also be selected to operate the same as the fan relay, reference the AUX relay function in the option menu. Contact ratings are 250 VAC maximum at 2 Amps.

9.4 Remote Override

The remote override contacts are (no power) **shorting contacts only**, which when closed, indicates to the control system to shut down the cabinet. The display will indicate remote override, inhibit all alarms, light, internal blower and close the exhaust valve (i.e. NU-951) if present.

9.5 Night Setback

The night setback contacts are (no power) **shorting contacts only**, which when closed, indicates to the control system to place the cabinet into night setback. The display will indicate night setback active, inhibit exhaust alarms, light and internal blower.

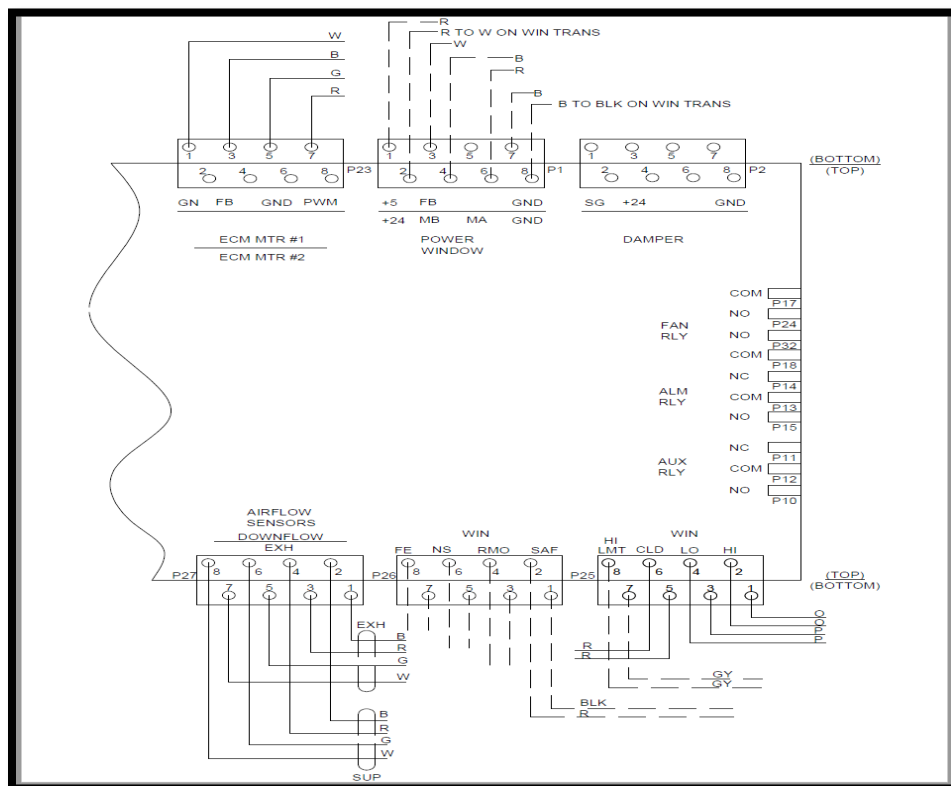

10.0 Optional Equipment

10.1 Ultraviolet Light



Ultraviolet light will injure your eyes. Avoid direct viewing at all times. Personnel should not be present when ultraviolet lamp is on

10.1.1 Overview

The germicidal ultraviolet is primarily intended for the destruction of bacteria and other microorganisms in the air or on directly exposed surfaces. Approximately 95% of the ultraviolet radiations from germicidal tubes are in the 253.7 nanometer region. This is a region in the ultraviolet spectrum which is near the peak of germicidal effectiveness. The exposure necessary to kill bacteria is the product of time and intensity. High intensities for a short period of time, or low intensities for a longer period are fundamentally equal in lethal dosage on bacteria (disregarding the life cycle of bacteria). The intensity of light falling on a given area is governed by the inverse law; that is the killing intensity decreases as the distance increases from the tube.

The germicidal tube is placed in the cabinet to provide an average intensity of 100 microwatts per square centimeter (for a new tube) falling on a horizontal plane defined by the center of the work surface. The minimum requirement per paragraph 5.12 of NSF Standard 49 is 40 microwatts per square centimeter (ref. NSF Std. #49, June, 1976).

Since ultraviolet rays will not penetrate ordinary glass, it is recommended that the sliding window be closed while the ultraviolet light is on within the cabinet; or that personnel leave the cabinet face area.

10.1.2 Operation

The operation of the ultraviolet light is accomplished by closing the sliding window and pressing the UV switch location on the front panel. The sliding window is interlocked to the ultraviolet light so, when the sliding window is raised, the ultraviolet light will turn off.

10.1.3 Precaution

The rays from germicidal tubes may cause a painful but temporary irritation of the eyes and reddening of the skin, if of sufficiently high intensity, or if exposure covers a prolonged period of time. For this reason, one should avoid direct eye and skin exposure to ultraviolet light. If exposure cannot be avoided, it is necessary for personnel to wear eye goggles or face shields, and long sleeve gowns with rubber gloves.

Since ultraviolet rays will not penetrate ordinary glass, it is recommended that the sliding window be closed while the ultraviolet light is on within the cabinet; or that personnel leave the cabinet face area.

10.1.4 Maintenance

The output of an ultraviolet light deteriorates with burning age. The useful life of the light is approximately 7000 hours under specific test conditions.



NOTE: Before testing with lamp off, the light may be cleaned with a lint-free cloth dampened with alcohol or ammonia and water.

It is recommended that either a time schedule be established or the tube's output be measured periodically and the tube replaced when its output falls below 40 microwatts per square centimeter or exceeds 7000 hours of operation. Lights should be allowed to operate approximately 5 to 10 minutes (longer when the light is in low temperatures) to warm up sufficiently before reading the output with a meter.

Energies Required to Destroy Some Microorganisms By Ultraviolet Radiations(e)

Mold Spores	Microwatt seconds per cm/2	Protozoa	Microwatt seconds per cm/2
Penicillium roqueforti	26,400	Paramecium	200,000(a)
Penicillium expansum	22,000		
Penicillium digitatum	88,000	Nematode Eggs	40,000(b)
Aspergillus glaucus	88,000		
Aspergillus flavus	99,000	Algae	22,000(c)
Aspergillus niger	330,000		
Rhizopus nigricans	220,000	Virus	
Mucor racemosus A	35,200	Bacteriophage (E. Coli)	6,600
Mucor racemosus B	35,200	Tobacco Mosaic	440,000
Oospora lactis	11,000	Influenza	3,400(d)
Yeasts			
Saccharomyces	13,200		
ellipsoideus	17,600		
Saccharomyces cerevisiae	13,200		
Brewers' yeast	6,600		
Baker's yeast	8,800		
Common yeast cake	13,200		
Bacteria			
Streptococcus lactis	8,800		
Strep. hemolyticus (alpha type)	5,500		
Staphylococcus aureus	6,600		
Staphylococcus albus	5,720		
Micrococcus sphaeroides	15,400		
Sarcina lutea	26,400		
Pseudomonas fluorescens	7,040		
Escherichia coli	7,040		
Proteus vulgaris	7,480		
Serratia marcescens	6,160		
Bacillus subtilis	11,000		
Bacillus subtilis spores	22,000		
Spirillum rubrum	6,160		

References:

- (a) Luckiesh, Matthew (1946) Application of Germicidal, Ethymal and Infrared Energy, D. Van Nostrand o., New York, New York, pp 253
- (b) Hollaender (1942) Aerobiology, A.A.A.S. (for 90% inactivation), pp 162
- (c) Ellis, C. and Wells, O.O. (1941) The Chemical Action of Ultraviolet Rays, Reinhold Publishing Corp., pp. 713-714
- (d) Hollaender, A., Oliphant, J.W. (1944) The inactivation effect of monochromatic ultraviolet. Radiation on Influenza Virus (for 90% inactivation) Jour. of Bact. 48, pp. 447-454
- (e) This table, "Energies Required to Destroy Some Microorganisms by Ultraviolet Radiations" comes from Westinghouse brochure entitled - "Westinghouse Sterilamp Germicidal Ultraviolet Tubes"

11.0 Electrical/Environmental Requirements

11.1 Electrical (Supply voltage fluctuations no to exceed +/- 10%)

*NU-565-400	115VAC,	60Hz,	1 Phase,	8 Amps
*NU-565-600	115VAC,	60Hz,	1 Phase,	10 Amps

*UL/UL-C Listed/Classified

11.2 Operational Performance (for indoor use only)

Environment Temperature Range:	60°F-85°F (15°C - 30°C)
Environment Humidity:	Maximum relative humidity 80% for temperatures up to 31°C decreasing linearly to 50% relative humidity at 40°C
Environment Altitude:	(2000 meters) maximum

11.3 Light Exposure

Standard Fluorescent Lighting @ 150 ft. candles (1614 LUX) maximum intensity.

11.4 Installation Category: 2.0

Installation category (over voltage category) defines the level of transient over voltage, which the instrument is designed to withstand safely. It depends on the nature of the electricity supply and it's over voltage protection means. For example, in CAT II, which is the category used for instruments in installations supplied from a supply comparable to public mains such as hospital and research laboratories and most industrial laboratories, the expected transient over voltage is 2500 V for a 230 V supply and 1500 V for a 120 V supply.

11.5 Pollution Degree: 2.0

Pollution degree describes the amount of conductive pollution present in the operating environment. Pollution degree 2 assumes that normally only non-conductive pollution such as dust occurs with the exception of occasional conductivity caused by condensation.

11.6 Chemical Exposure

Chemical exposure should be limited to antibacterial materials used for cleaning and disinfecting.

USE OF CHLORINATED AND HALOGEN MATERIALS IN THE CABINET MAY DAMAGE STAINLESS STEEL.

Equipment decontamination can be accomplished by non-condensing gas or vapor paraformaldehyde, Hydrogen Peroxide or Chlorine Oxide following. NSF/ANSI 49, Annex I-2 (formerly Annex G).

11.7 EMC Performance (classified for light industrial)

Emissions:	EN61326
Immunity:	EN61326



Class A equipment is intended for use in an industrial environment. In the documentation for the user, a statement shall be included drawing attention to the fact that there may be potential difficulties in ensuring electromagnetic compatibility in other environments, due to conducted as well as radiated disturbances.

12.0 Disposal and Recycle

Cabinets that are no longer in use and are ready for disposal contain reusable materials. ALL components with the exception of the HEPA filters may be disposed and/or recycled after they are known to be properly disinfected.

 **NOTE:** Follow all local, state and federal guidelines for disposal of HEPA filter solid waste.



BIOHAZARD



Prior to any disassembly for disposal, the cabinet must be decontaminated.



RECYCLE



LEAD FREE

Component

Base Cabinet	Stainless Steel
Front Grill	Stainless Steel
Worksurface	Stainless Steel
Window Faring	Stainless Steel
Window Glides	HDPE
Window	Safety Glass
Window Frame	Stainless Steel
Front Service Panel	Painted Steel
Front Decorative Panel	Painted Steel
Control Center	Painted Steel
Supply Diffuser	Aluminum
Exhaust Filter	Aluminum
HEPA Filter Frames	Painted Steel
Hepex Bag	PVC
Blower Wheel & Housing	Steel
Motor	Various Steel/Copper
Printed Wiring Assembly	Lead Free Electronic
Wire	PVC Coated Copper
Ballasts	Various Steel, Electronic
Armrest	PVC or Stainless Steel
Connectors	Nylon
Hardware	Stainless Steel and Steel

Material

 **Note:** Material type can be verified with use of a magnet with stainless and aluminum being non-magnetic.

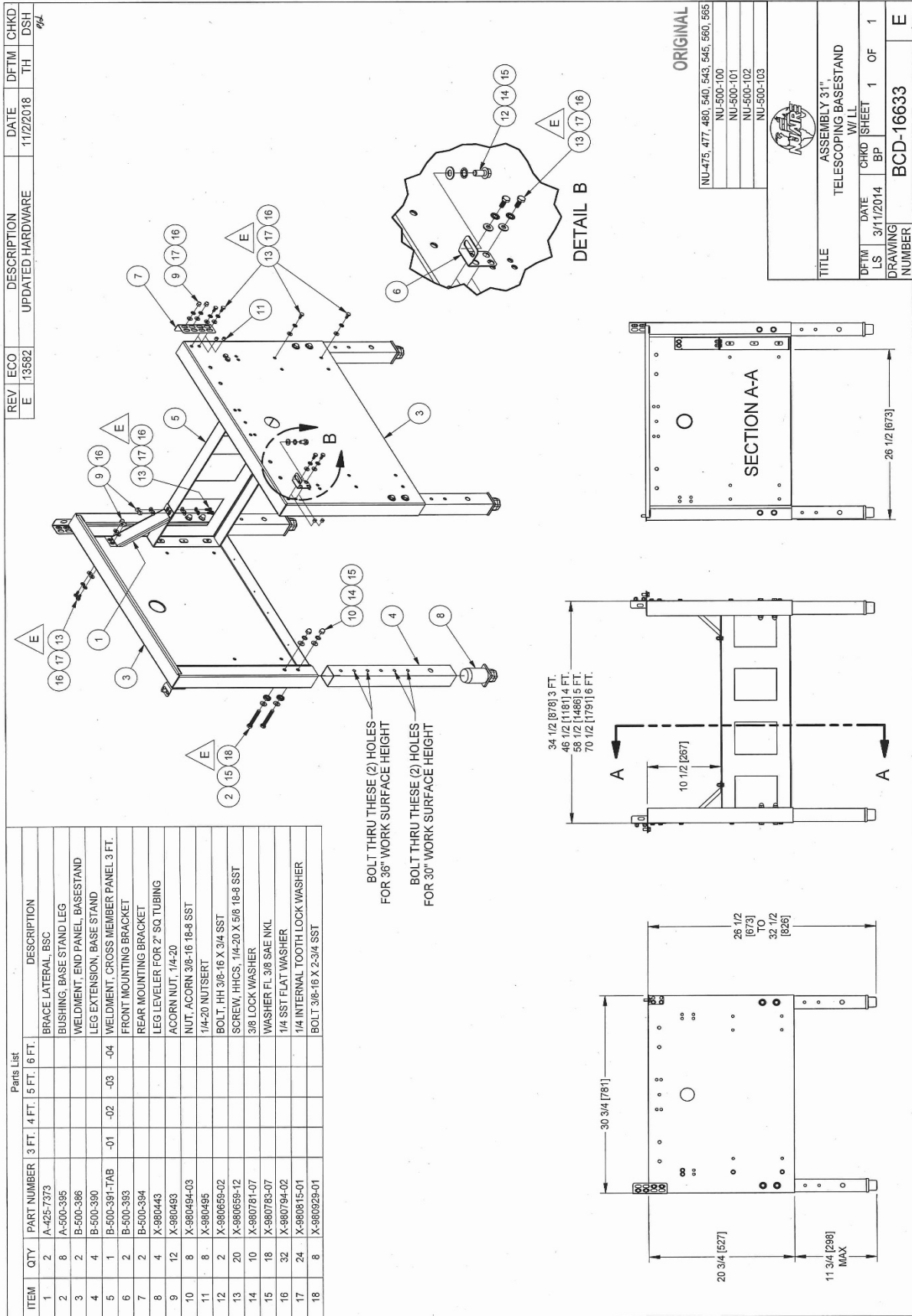

REV	ECD	DESCRIPTION	DATE	DRFT	CHKD
A		RELEASED TO PRODUCTION	4/20/2017	TH	BP

CONTROL CENTER REMOVAL PROCEDURE

CAUTION
DISCONNECT ALL ELECTRICAL SERVICE TO UNIT BEFORE STARTING PROCEDURE

- 1A.) REMOVE (2) #8-32 SCREWS FROM TOP OF CONTROL CENTER AND GENTLY LET CONTROL CENTER OPEN ON SAFETY STRAPS.
- 2A.) REMOVE MINIHILIC GAUGE HOSE (IF PRESENT) (HOSE CLAMP/MAG GAUGE).
- 3A.) DISCONNECT ELECTRICAL CONNECTORS AND CABLE CLAMPS SO THEY ARE LOOSE TO THE MAIN CABINET (BOTH SIDES).
- 4A.) REMOVE A 1/4-20 NUT FROM CONTROL CENTER HOLDING THE SAFETY STRAP. (BOTH ENDS)
- 5A.) LIFT CONTROL CENTER AND PULL UP AND AWAY.
- 6A.) TO ATTACH CONTROL CENTER REVERSE THE ABOVE STEPS.

FRONT DECORATIVE PANEL REMOVAL PROCEDURE

- 1A.) REMOVE (2) #8-32 SCREWS FROM TOP OF CONTROL CENTER AND GENTLY LET CONTROL CENTER OPEN ON SAFETY STRAPS.
- 1B.) REMOVE (3) FASTENERS FROM TOP EDGE OF PANEL.
- 2B.) TO ATTACH FRONT DECORATIVE PANEL REVERSE THE ABOVE STEPS

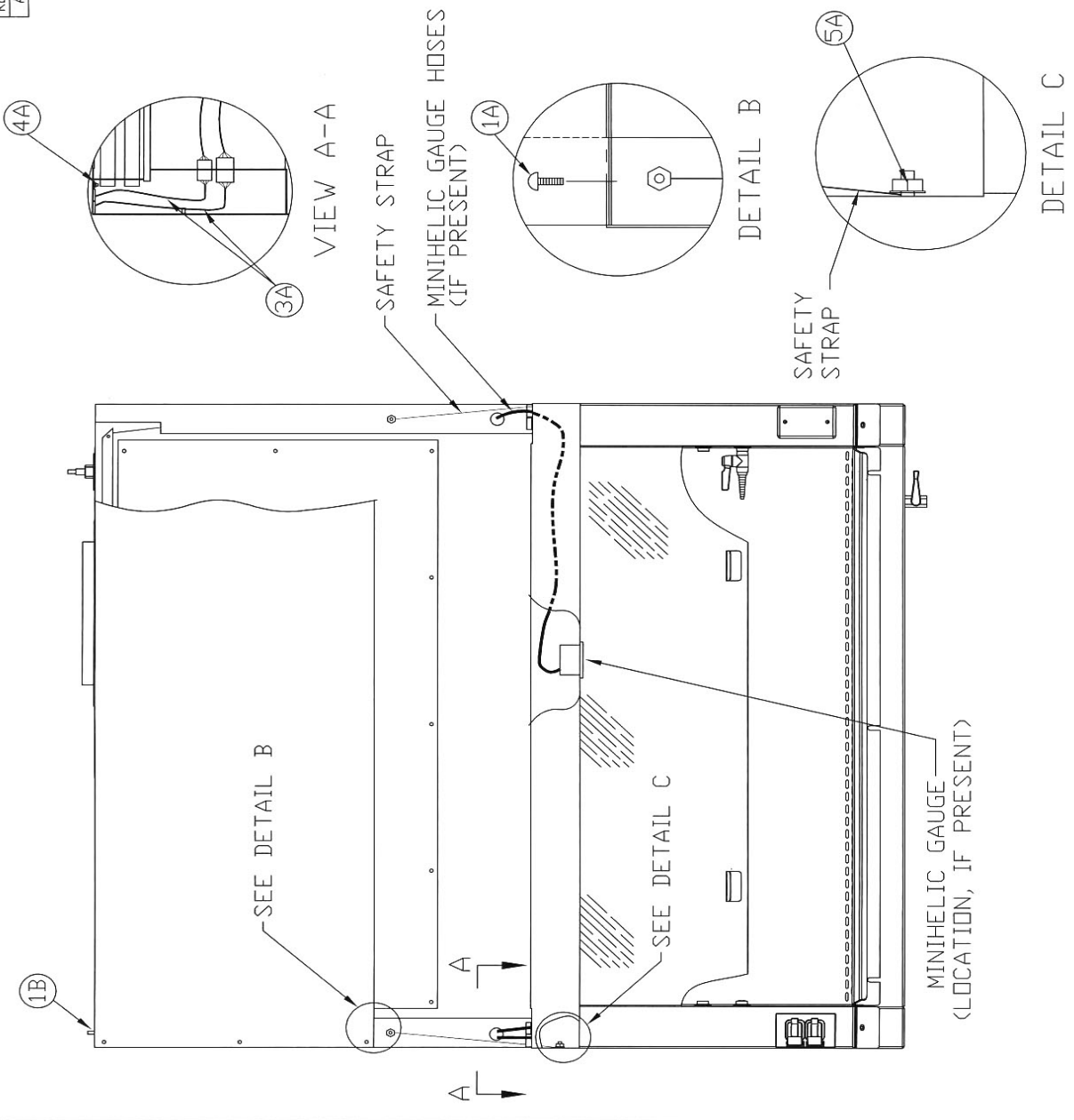



		ORIGINAL
NU-550 / 560 / 565		
CONTROL CENTER & FRONT DECORATIVE PANEL		
DRFT	TH	DATE
		4/20/17
DRAWING NUMBER		BCD-19031
		A

REV	ECO	DESCRIPTION	DATE	DRAFT	CHKD
C	13471	ADDED NU-677	8/18/2017	TH	BP

WINDOW GLIDE ADJUSTMENT

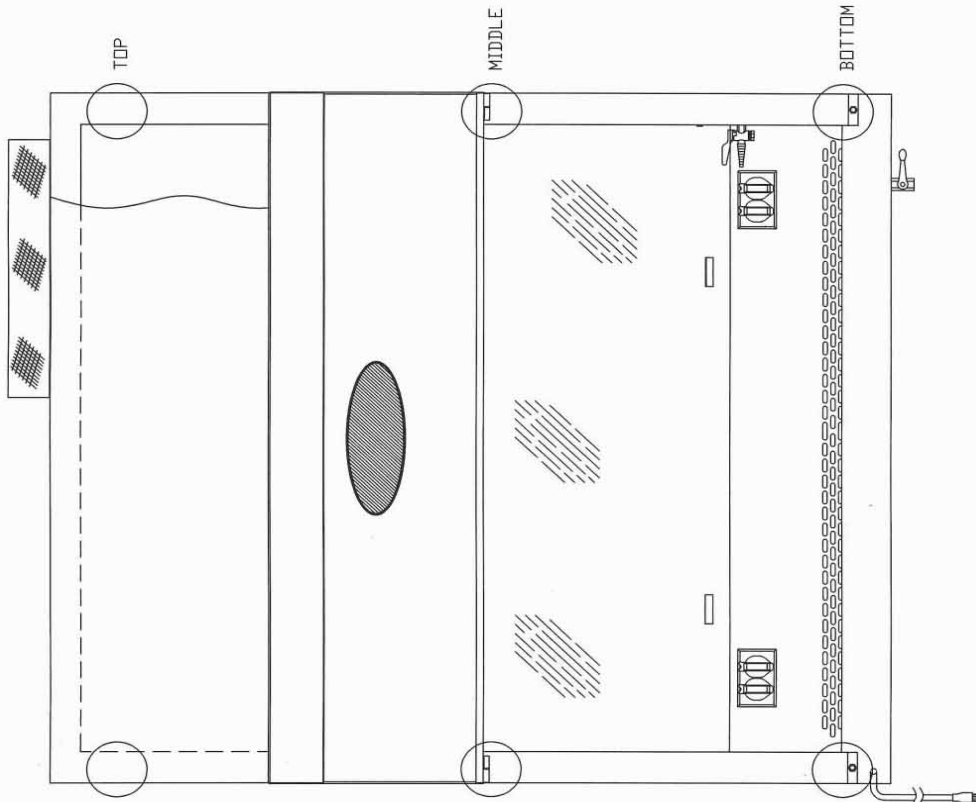
1. WINDOW GLIDE ADJUSTMENT IS ACCOMPLISHED BY MOVING THE RIGHT OR LEFT WINDOW FARING ASSEMBLY. ADJUSTING OR MOVING EITHER WINDOW FARING ASSEMBLY IN OR OUT WILL PROVIDE MORE OR LESS FRICTION ON THE SLIDING WINDOW AS DESIRED.
2. THE WINDOW ASSEMBLY IS LOOSENEED BY (3) 1/4-20 NUTS (BOTTOM, MIDDLE (BEHIND THE CONTROL CENTER) AND TOP (BEHIND DECORATIVE PANEL)) AS INDICATED ON THE ILLUSTRATION.
3. ONCE ADJUSTMENT IS COMPLETE, VERIFY WINDOW SWITCHES STILL MAKE CONTACT THROUGH THE FULL SLIDING WINDOW RANGE.
 WINDOW HIGH SWITCH - ALARM
 WINDOW CLOSED SWITCH - BLOWER OFF OR NITE CARE
 WINDOW LOW SWITCH - ALARM



		ORIGINAL	
NU-540 / 543 / 550 / 560 / 565 / 677		SLIDING WINDOW ASSY & ADJUSTMENT	
DFTM	LS	9/12/13	CHKD
DRAWING NUMBER		BCD-16376	
		SHEET 1 OF 1	
		C	

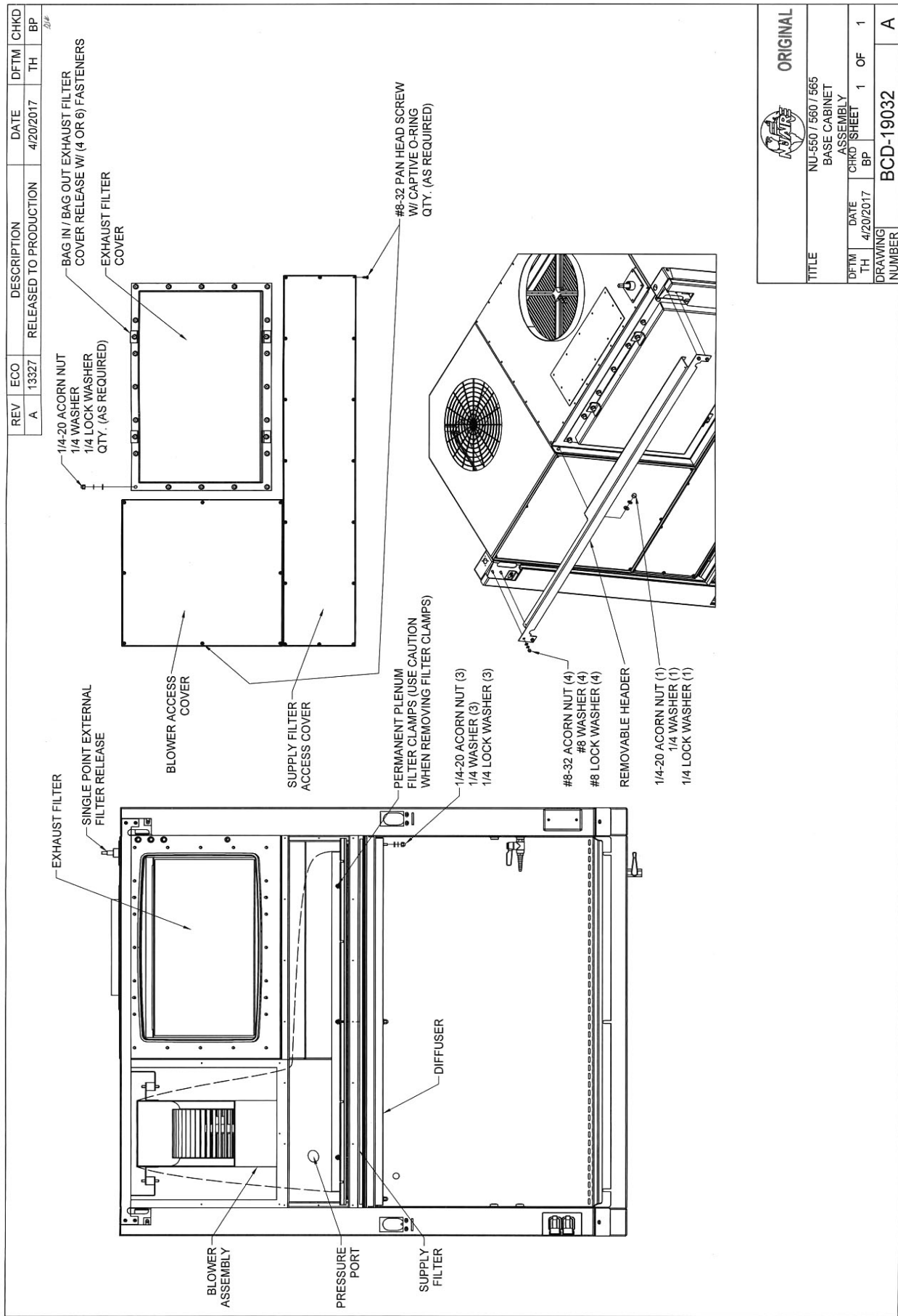

REV	ECO	DESCRIPTION	DATE	DFTM	CHKD
A	13327	RELEASED TO PRODUCTION	4/20/2017	TH	BP

TITLE		DATE		DFTM		CHKD	
NJ-5507/5607/565		4/20/2017		TH		BP	
BASE CABINET ASSEMBLY		ASSEMBLY		1 OF 1		1	
DRAWING NUMBER		BCD-19032				A	

ORIGINAL

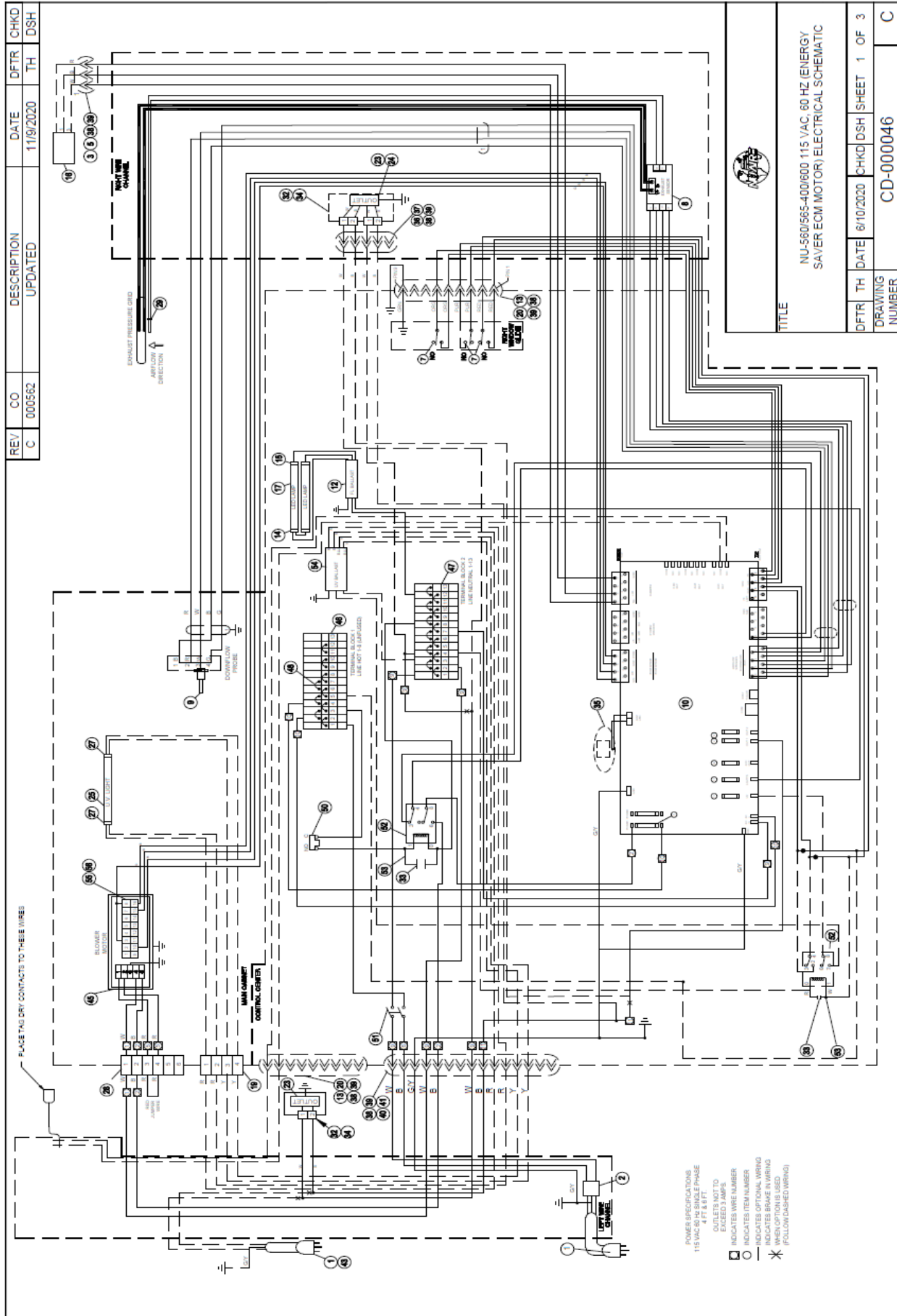

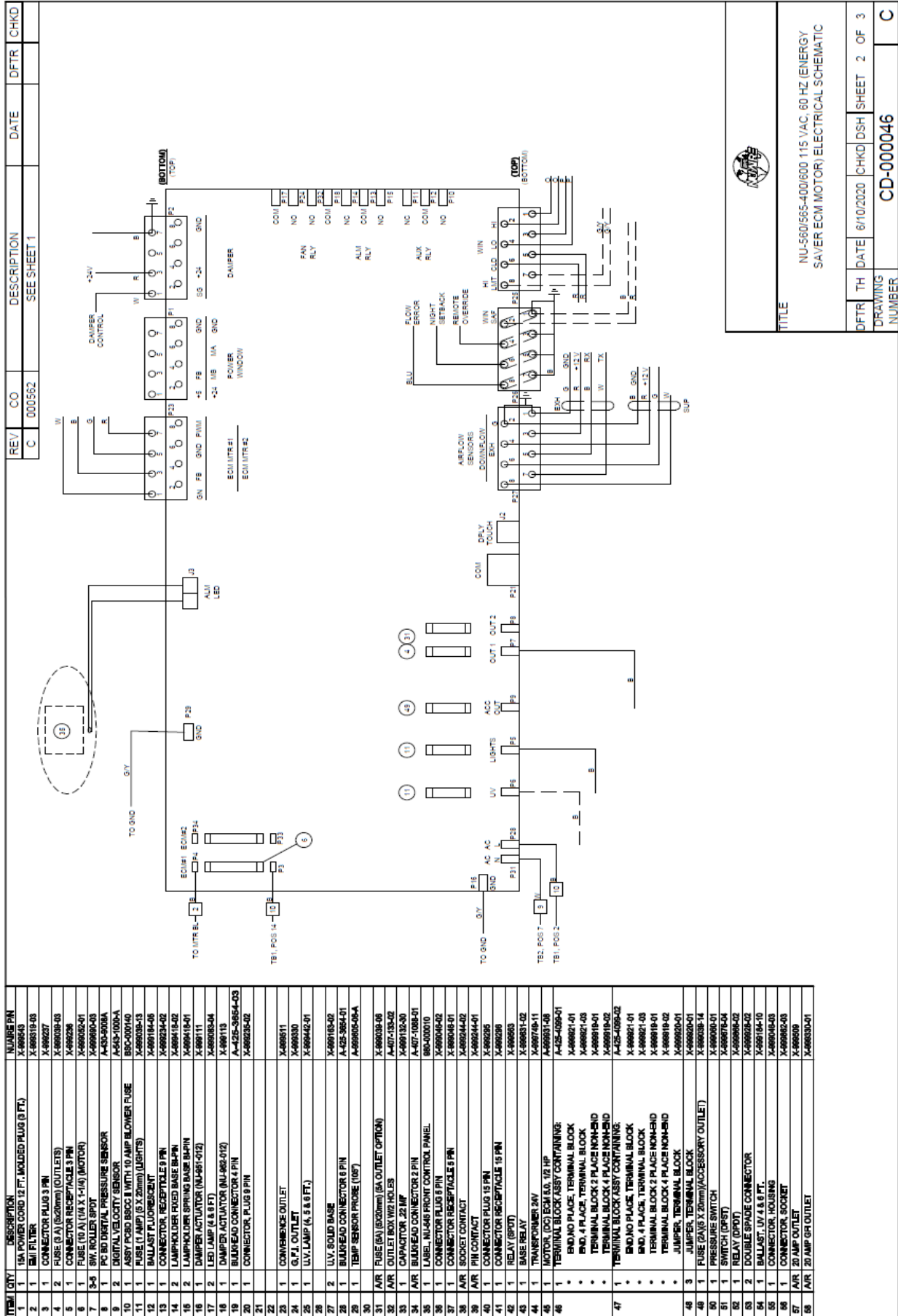

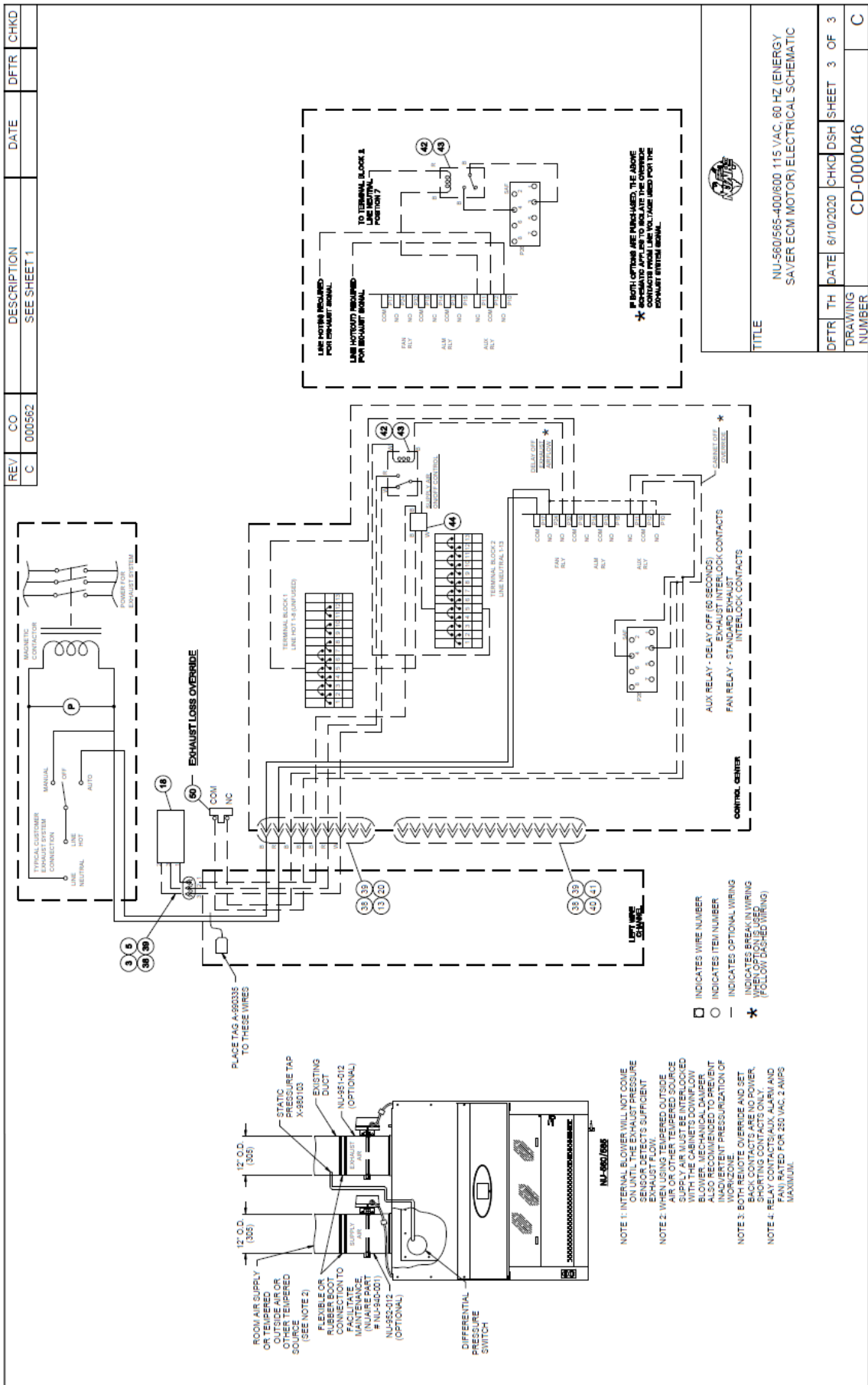

REV	CO	DATE	DFTR	CHKD
C	000562			
DESCRIPTION		DATE	DFTR	CHKD
SEE SHEET 1				

TITLE		DATE	DFTR	CHKD	DSH	SHEET	3	OF	3
NU-560/565-400/600 115 VAC, 60 HZ (ENERGY SAVER ECOM MOTOR) ELECTRICAL SCHEMATIC		6/10/2020							
DRAWING NUMBER		CD-000046							