

**LabGard® ES Energy Saver
Class II Laminar Flow
Biosafety Cabinet**

**Models
NU-545-300E/400E/500E/600E
Bench/Console**

Operation and Maintenance Manual

**July, 2021
Revision 3
Series C,**



Manufactured By:
Nuair, Inc.
2100 Fernbrook Lane
Plymouth, MN 55447
Toll-Free: 1-800-328-3352
In Minnesota: (763)-553-1270
Fax: (763)-553-0459

Congratulations!

You have just purchased one of the finest Laminar Flow Biosafety Cabinets available. With proper care, maintenance (certification), and laboratory procedure, this cabinet will give you years of product and personnel protection from particulate contaminants as prescribed in NSF/ANSI 49. Please read this manual carefully to familiarize yourself with proper installation, maintenance and operation of the cabinet. Other reference and guideline materials are available through the following web sites;

www.hc-sc.gc.ca

www.cdc.gov/od/ohs/

www.absa.org

www.cabs-acsb.ca

www.ebsaweb.eu

www.inspection.gc.ca

www.who.int

www.biosafety.be

www.hse.gov.uk

www.nsf.org

www.cetainternational.org

www.Nuaire.com

About this Operation and Maintenance Manual

The information contained in this manual is intended to reflect our current production model along with the more frequently purchased options. Any unique additions, modifications, or shop drawings are appended in the back flap of this manual, along with any modifications and/or additions to procedures as outlined in this manual. A copy of the original factory test report is also appended to this manual. In case this manual and/or test report is lost or misplaced, Nuairé retains a copy in our files. A replacement copy can be obtained by calling or writing Nuairé, Inc. stating the model number and serial number and a brief description of the information desired.

**LabGard® ES Energy Saver
Class II Laminar Flow Biosafety Cabinet
Models NU-545-300E/400E/500E/600E Operation and Maintenance Manual**

Table of Contents

Section No. 1.....	General Information
Section No. 2.....	Models and Features
Section No. 3.....	Warranty
Section No. 4.....	Shipments
Section No. 5.....	Installation Instructions
5.1.....	Location
5.2.....	Set-up Instructions
5.3.....	Testing Methods and Equipment
Section No. 6.....	Operating the NU-545E
6.1.....	TouchLink™ Control System
6.2.....	Operating Guidelines
6.3.....	Operating Sequence
6.4.....	Ergonomics
6.5.....	Cleaning Procedures
Section No. 7.....	General Maintenance
7.1.....	Decontamination
7.2.....	LED Lamp Replacement
7.3.....	HEPA Filter/Motor Replacement
7.4.....	Sliding Window Replacement and Manual Adjustment
7.5.....	Airflow Control System Setup and Calibration
7.6.....	HEPA Filter Leak test
7.7.....	Airflow Smoke Pattern Test
7.8.....	Site Installation Assessment Test
7.9.....	Cleanliness Classification Test for Pharmacy Application
7.10.....	Main Control Board Description and Replacement
7.11.....	Digital Airflow Sensor Description and Replacement
Section No. 8.....	Error Messages, Troubleshooting and Option-Diagnostics
Section No. 9.....	Remote Contacts
Section No. 10.....	Optional Equipment
10.1.....	Ultraviolet Light
Section No. 11.....	Electrical/Environmental Requirements
Section No. 12.....	Disposal and Recycle

Manual Drawings

ACD-16296.....	NU-545 Airflow Schematic
CD-000047.....	NU-545-300E Specification Drawing
CD-000048.....	NU-545-400E Specification Drawing
CD-000049.....	NU-545-500E Specification Drawing
CD-000050.....	NU-545-600E Specification Drawing
BCD-16882.....	Drain Valve Installation
BCD-16509.....	Auto Decontamination Setup

Assembly Drawings

BCD-16633.....	Base Stand Assembly
BCD-16301.....	Control Center and Front Decorative Panel Assembly
BCD-16297.....	Sliding Window Assembly and Adjustment
BCD-16299.....	Base Cabinet Assembly
BCD-16298.....	NU-545 Window Assembly Hinge Operation
BCD-12281.....	Auto Window Switch/Cable Adjustment and Maintenance
BCD-12282.....	Auto Window Cable and Window Assembly

Electrical Schematics

CD-000026 (sheet 1 and 2).....	NU-545-300E/400E/500E/600E Electrical Schematic
--------------------------------	---

**LabGard® ES Energy Saver
Class II, Type A2 Laminar Flow
Biosafety Cabinet
Models
NU-545-300E/400E/500E/600E
Manufactured by:
Nuaire, Inc. - Plymouth, Minnesota, U.S.A.**

1.0 General Information

1.1 Description

The LabGard® ES Model NU-545E Laminar Flow Biosafety Cabinet (LFBSC) is a bench/table top model, optionally available with a base support stand, for operation as a console model. The LabGard® ES model NU-545E utilizes an Energy Saver DC ECM motor optimally determined forward curved fan for each model size/width to maximize both energy efficiency and filter loading capacity. The Energy Saver ECM motor is controlled airflow setpoints via a solid-state DC motor controller with digital dual thermistor airflow sensors that provide an automatic compensation (constant volume control) for both filter loading and line voltage variances.

The Laminar Flow Biosafety Cabinet, (LFBSC) is a product resulting from the development of the "laminar flow" principle (see Airflow Schematic) and the application of environmental controls as required in the field of biological research or chemical containment. The LFBSC, when used with proper technique, is an effective primary engineering control in obtaining the optimum product quality while reducing the potential for exposure of both product and personnel to airborne biological or particulate chemical agents in low to moderate risk-hazard research and drug preparation or product operations, as prescribed by the Center for Disease Control (CDC) Atlanta, Georgia.

The NU-545E bench LFBSC meets the requirements of a Class II, since the cabinet conforms to the following requirements:

1. Maintains a minimum inflow velocity of 100 LFPM (.51mps) through the work access opening.
2. Has HEPA filtered downflow air that is mixed with the inflow air from a common exhaust plenum.
3. Discharges a percentage of air to the outside atmosphere after HEPA filtration.
4. Has all biologically contaminated ducts and plenums under negative pressure or surrounded by negative pressure.

If working with volatile chemicals, the cabinet must be connected to an external exhaust system with a canopy transition. Type A2 cabinets may be used for work with volatile chemicals if permitted by a chemical risk assessment.

1.2 Safety Instructions

These safety instructions describe the safety features of the LabGard® ES Model NU-545E LFBSC.

The safety cabinet has been manufactured using the latest technological developments and has been thoroughly tested before delivery. **However, the cabinet may present potential hazards if it is not installed and used as instructed for its intended purpose or is used outside of operating parameters.** Therefore, the following procedures must always be observed:

- The safety cabinet must be operated only by trained and authorized personnel.
- For any operation of this cabinet, the operator must prepare clear and concise written instructions for operating and cleaning, utilizing applicable safety data sheets, plant hygiene guidelines, and technical regulations, in particular.
 - which decontamination measures are to be applied for the cabinet and accessories
 - which protective measures apply while specific agents are used
 - which measures are to be taken in the case of an accident
- Repairs to the device must be carried out only by trained and authorized expert personnel.
- Keep these operating instructions close to the cabinet so that safety instructions and important information are always accessible.
- Should you encounter problems that are not detailed adequately in the operating instructions, please contact your Nuair Representative of Nuair technical Services.

1.3 Explanation of Symbols



Safety alert symbol indicates a potentially hazardous situation which, if not avoided, could result in death of serious injury.

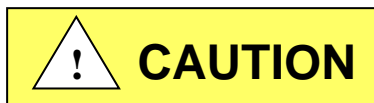

Safety alert symbol indicates a potentially hazardous situation which, if not avoided, may result in minor or moderate injury.

CAUTION

CAUTION used without the safety alert symbol indicates a potentially hazardous situation which, if not avoided, may result in property damage.



Potential electrical hazard, only qualified person to access.

 **NOTE:**

Used for important information.



Biohazard



Flammable Hazard



Ground, Earth



Lead Free



Hazardous Gases! Personal Protection Equipment Required.



Chemical Hazard

REV	ECD	DESCRIPTION	DATE	DRFTCHKD
A	12131	RELEASED TO PRODUCTION	9/12/13	LS BP

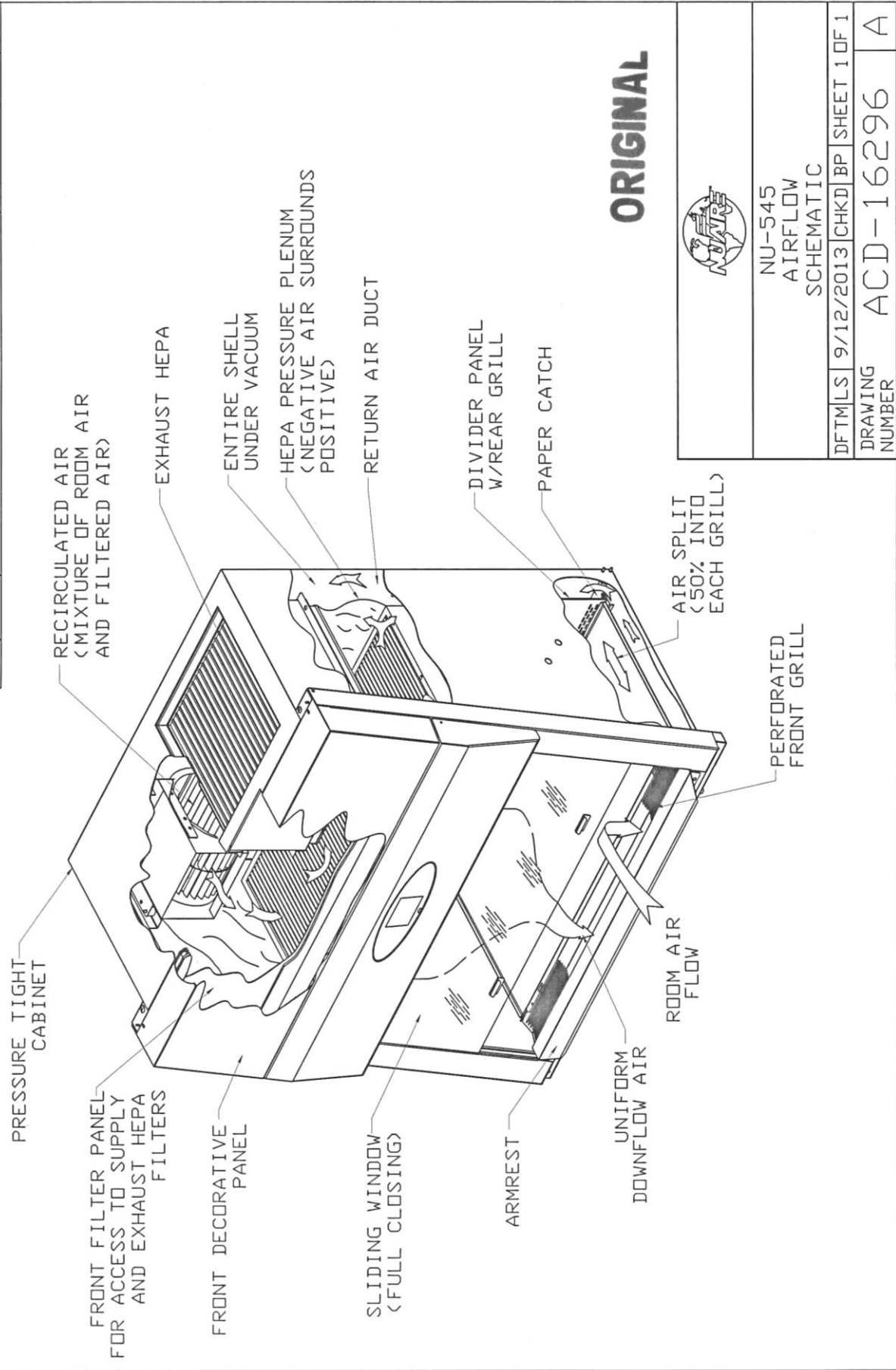

ORIGINAL



NU-545
AIRFLOW
SCHEMATIC

DFTMLS	9/12/2013	CHKD	BP	SHEET 1 OF 1
DRAWING NUMBER				ACD-16296 A

2.0 Models and Features

The model NU-545E, LabGard® ES, Class II Laminar Flow Biosafety Cabinet is manufactured in four sizes:

3 ft. (.9m)

4 ft. (1.2m)

5 ft. (1.5m)

6 ft. (1.8m)

REV	CO	DESCRIPTION	DATE	DFTM	CHKD
B	000485	UPDATED WORK TRAY	12/21/2020	TH	DSH

NOTE: THIS CABINET CONTAINS ELECTRONIC COMPONENTS THAT MAY CAUSE SOME GROUND FAULT CIRCUIT INTERRUPTER (GFCI) DEVICES TO INADVERTENTLY TRIP DUE TO INHERENT DESIGN DIFFERENCES. USE AT YOUR OWN RISK.

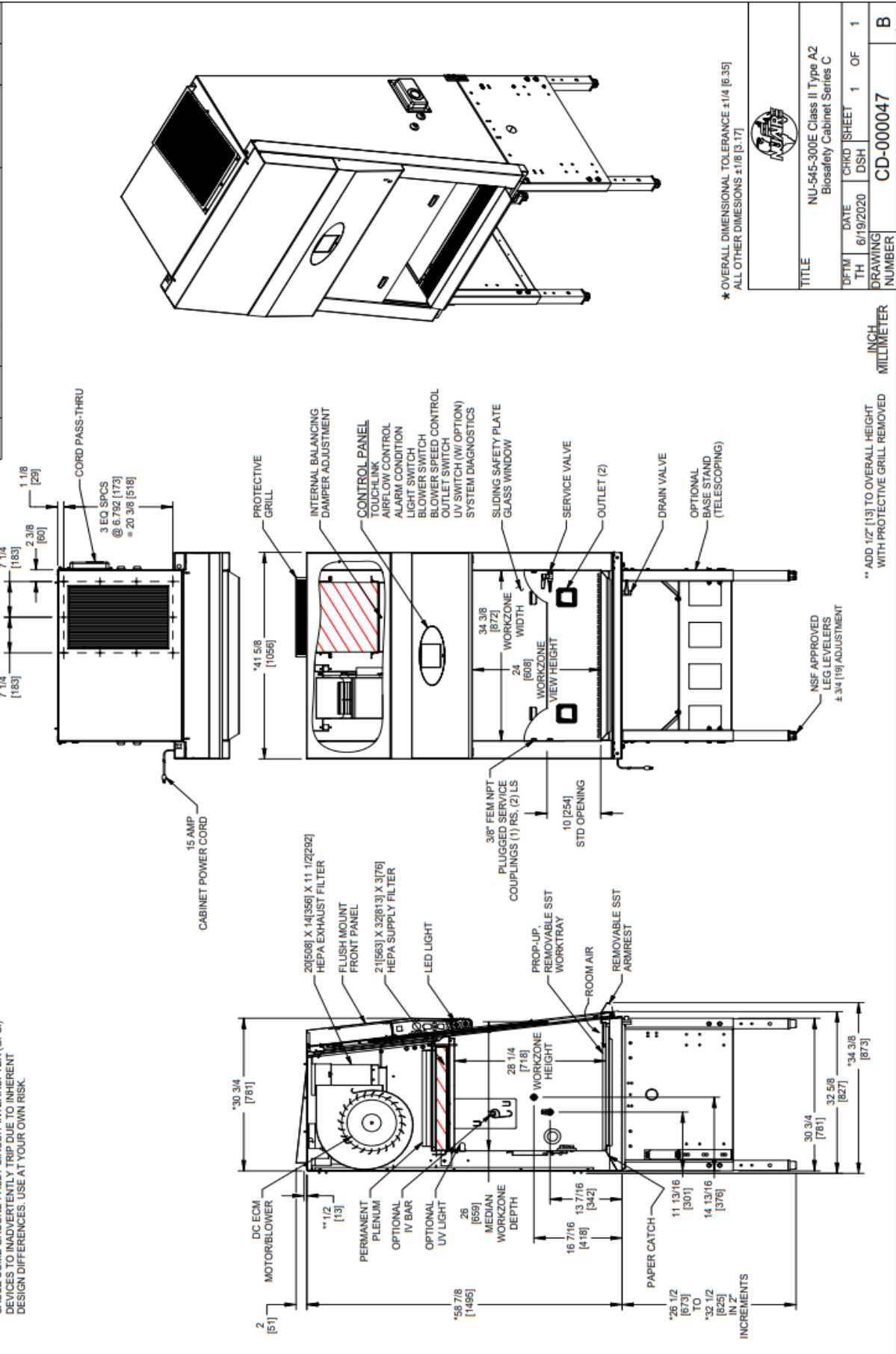

* OVERALL DIMENSIONAL TOLERANCE ±.1/4 [6.35]
ALL OTHER DIMENSIONS ±.1/8 [3.17]



TITLE		NU-545-300E Class II Type A2 Biosafety Cabinet Series C	
DFTM	DATE	CHKD	SHEET
TH	6/19/2020	DSH	1 OF 1
DRAWING NUMBER		CD-000047	

** ADD 1/2" [13] TO OVERALL HEIGHT WITH PROTECTIVE GRILL REMOVED

INCH MILLIMETER

REV	CO	DESCRIPTION	DATE	DFTM	CHKD
B	000485	UPDATED WORK TRAY	12/21/2020	TH	DSH

NOTE: THIS CABINET CONTAINS ELECTRONIC COMPONENTS THAT MAY CAUSE SOME GROUND FAULT CIRCUIT INTERRUPTER (GFCI) DEVICES TO INADVERTENTLY TRIP DUE TO INHERENT DESIGN DIFFERENCES. USE AT YOUR OWN RISK.

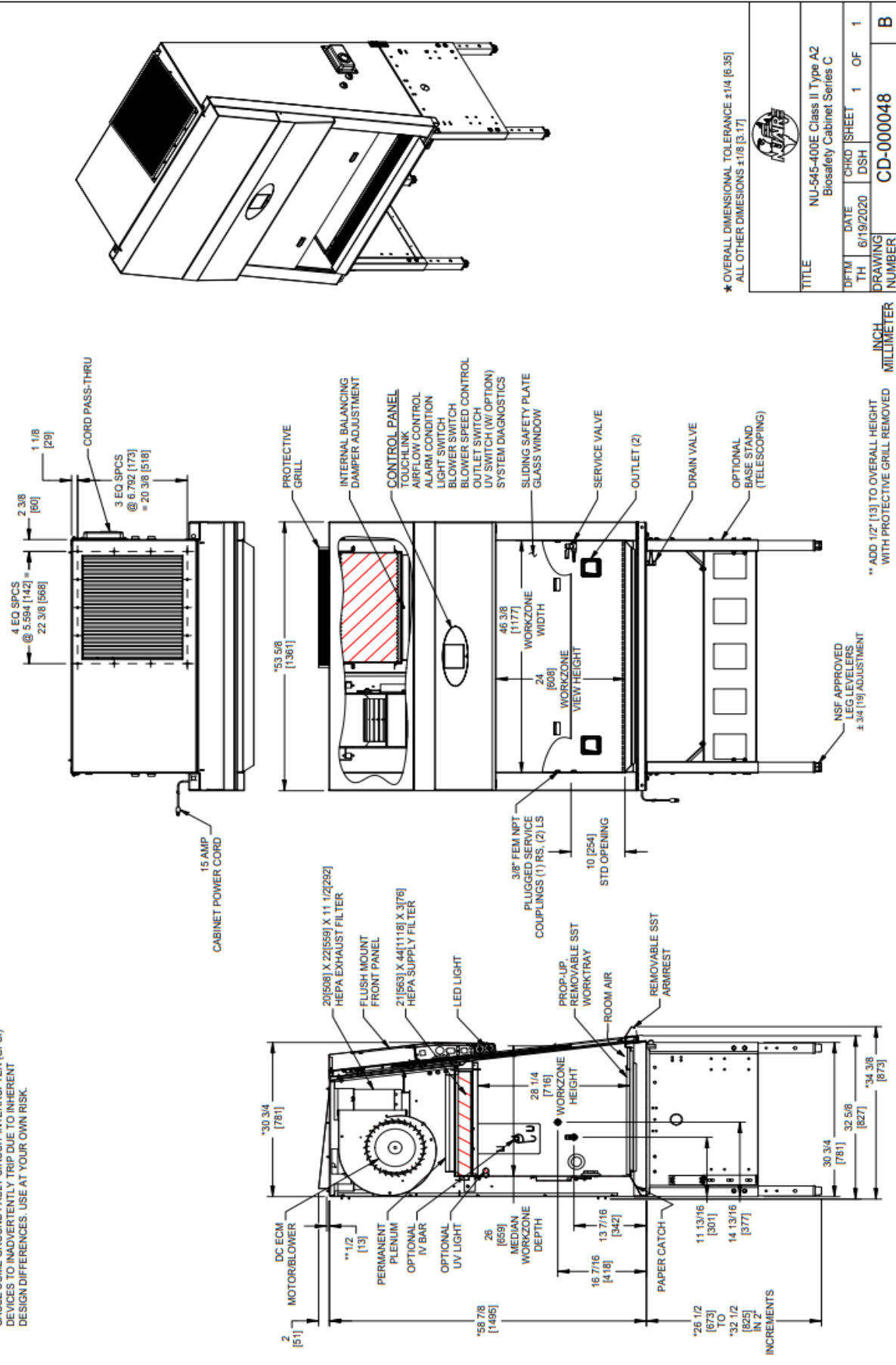

* OVERALL DIMENSIONAL TOLERANCE ±1/4 [6.35]
ALL OTHER DIMENSIONS ±1/8 [3.17]

TITLE		NU-545-400E Class II Type A2 Biosafety Cabinet Series C	
DFTM	DATE	CHKD	TSHEET
TH	6/19/2020	DSH	1 OF 1
DRAWING NUMBER		CD-000048	

** ADD 1/2" [13] TO OVERALL HEIGHT WITH PROTECTIVE GRILL REMOVED

REV	CO	DESCRIPTION	DATE	DFTM	CHKD
B	000485	UPDATED WORK TRAY	12/21/2020	TH	DSH

NOTE: THIS CABINET CONTAINS ELECTRONIC COMPONENTS THAT MAY CAUSE SOME GROUND FAULT CIRCUIT INTERRUPTER (GFCI) DEVICES TO INADVERTENTLY TRIP DUE TO INHERENT DESIGN DIFFERENCES. USE AT YOUR OWN RISK.

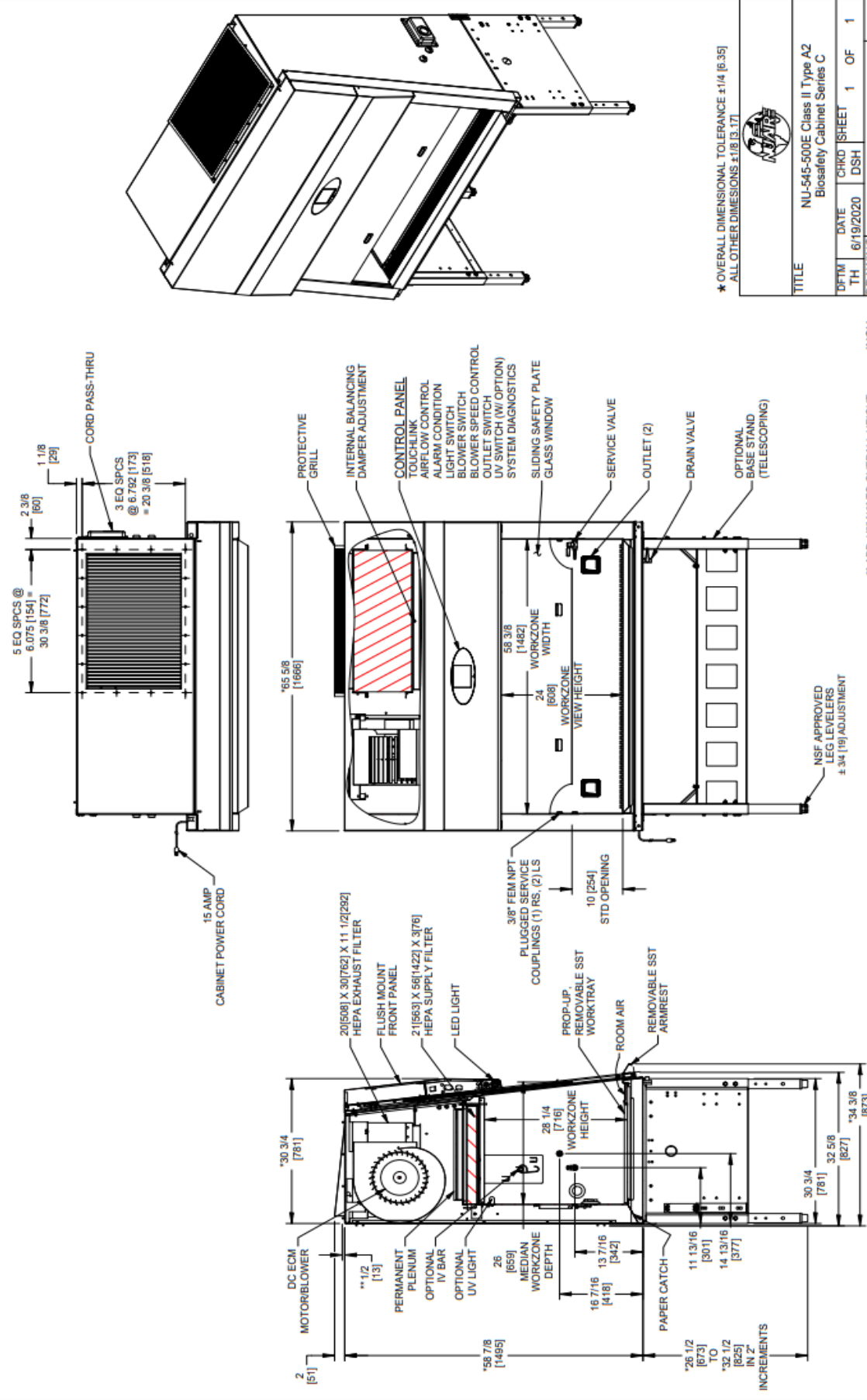

* OVERALL DIMENSIONAL TOLERANCE ±1/16 (B.35)
 ** ALL OTHER DIMENSIONS ±1/8 (B.17)

TITLE NU-545-500E Class II Type A2 Biosafety Cabinet Series C	
DFTM TH	DATE 6/19/2020
CHKD DSH	SHEET 1 OF 1
DRAWING NUMBER	INCH MILLIMETER
CD-000049	
B	

** ADD 1/2" (13) TO OVERALL HEIGHT WITH PROTECTIVE GRILL REMOVED

REV	CO	DESCRIPTION	DATE	DFTM	CHKD
B	000485	UPDATED WORK TRAY	12/21/2020	TH	DSH

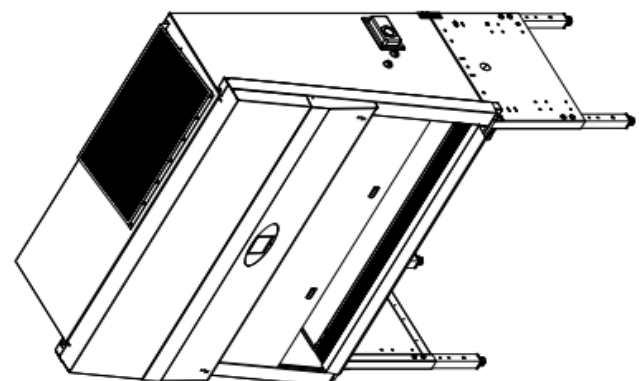
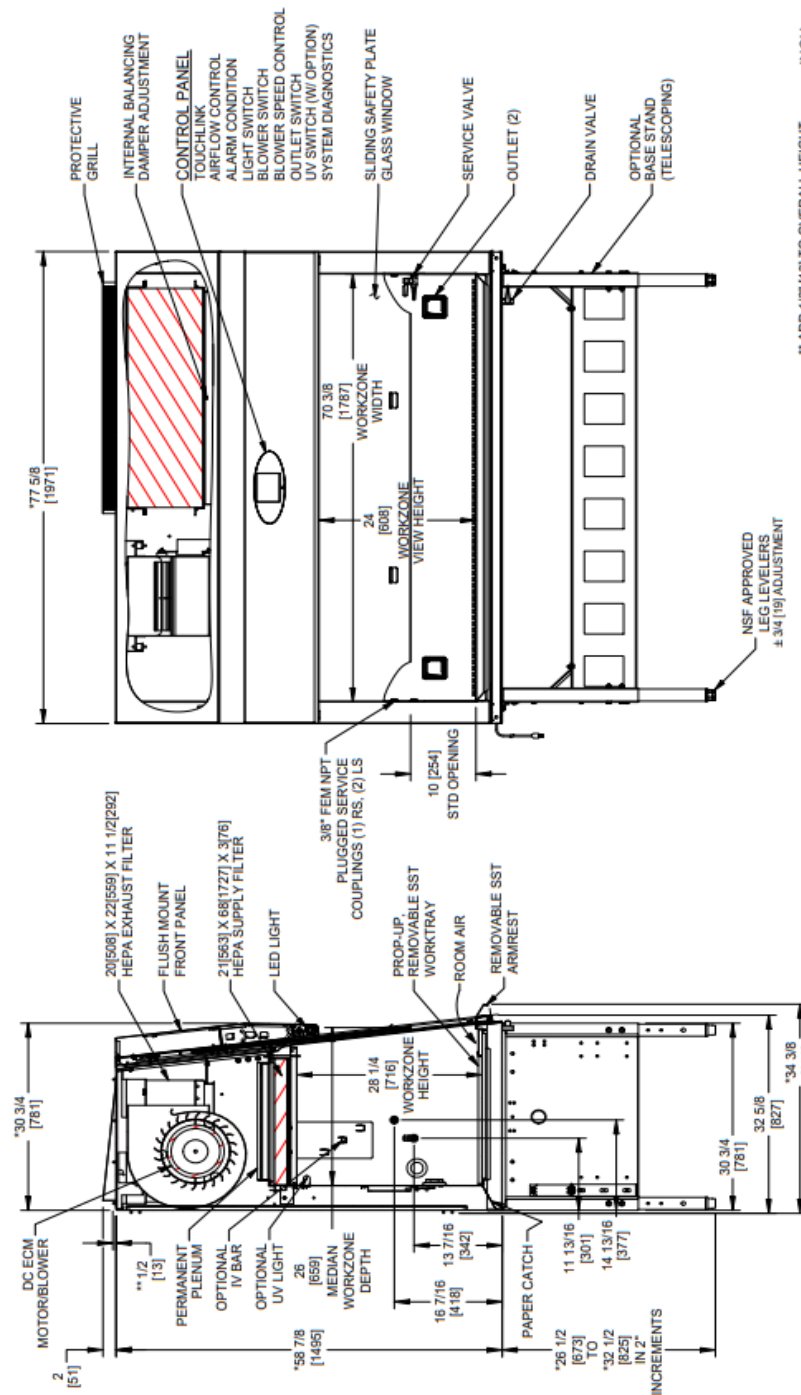
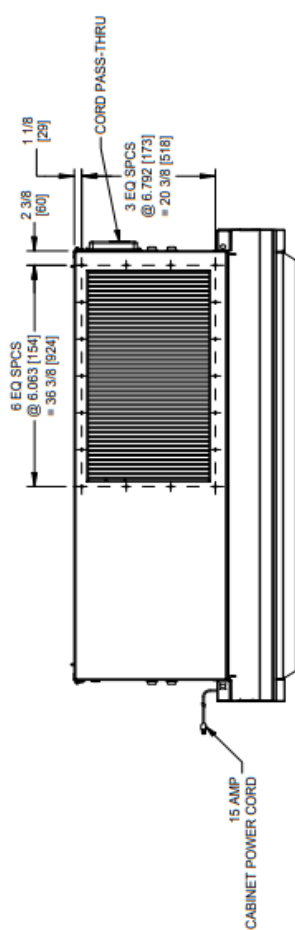

* OVERALL DIMENSIONAL TOLERANCE ±.14 [6.35]
 ALL OTHER DIMENSIONS ±.18 [3.17]



TITLE
 NU-545-600E Class II Type A2
 Biosafety Cabinet Series C

DFTM	DATE	CHKD	SHEET	1	OF	1
TH	6/19/2020	DSH				
DRAWING NUMBER	CD-000050					B

** ADD 1/2" [13] TO OVERALL HEIGHT WITH PROTECTIVE GRILL REMOVED
 INCH MILLIMETER

REV	ECD	DESCRIPTION	DATE	DRFT	CHKD
B	12636	UPDATE MODEL NUMBERS	2/20/15	IW	BP

NU-540E(S) / 543E(S) / 545E(S) DRAIN VALVE INSTALLATION	ORIGINAL
DFTM/IW	5/19/14
CHKD/BI	SHEET 1 OF 1
DRAWING NUMBER	BCD-16882
	B

THE NUAIRE BIOLOGICAL SAFETY CABINET HAS A DRAIN PAN BELOW THE WORK TRAY DESIGNED TO SUBSTANTIALLY DRAIN SPILLS THAT ACCIDENTALLY OCCUR IN THE WORK ZONE. A 3/8" BALL DRAIN VALVE IS LOCATED ON THE FRONT OF THE CABINET FOR CONVENIENCE. THE CABINET BASE MEETS THE NSF OBJECTIVE WITH THE CAPABILITY OF BEING SEALED TO THE BENCH UPON WHICH IT RESTS.

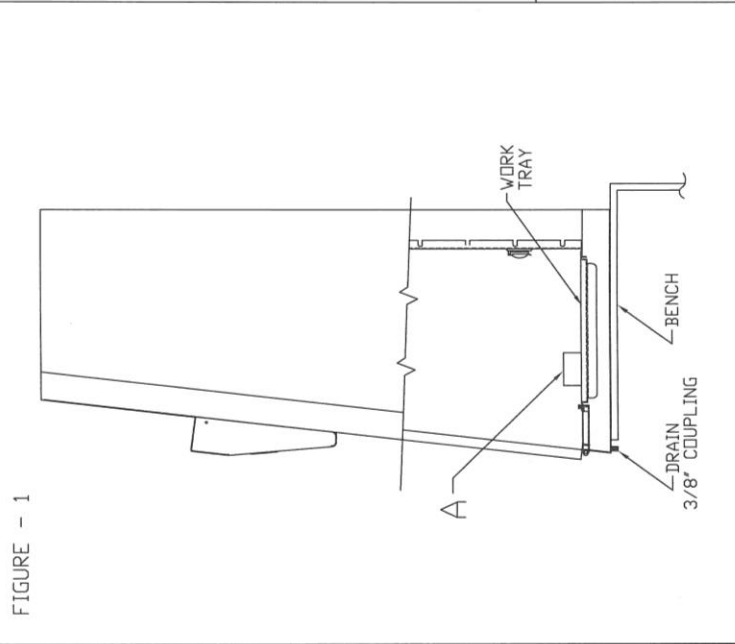
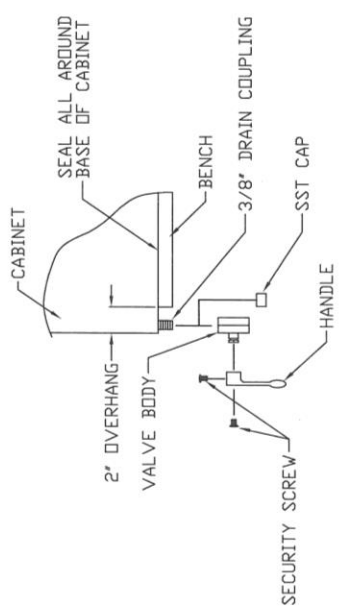

FIGURE - 1

- 1.) PLACE THE CABINET ON A BENCH WITH APPROXIMATELY 2 (51mm) INCHES OVERHANG CLEARANCE FOR INSTALLATION OF DRAIN VALVE.
- 2.) REMOVE CARTON - A AND CONTENTS FROM WORK AREA, AND INSTALL THE DRAIN VALVE AS SHOWN IN FIGURE 2.

FIGURE - 2



3. REMOVE HANDLE USING SPECIAL TOOL PROVIDED TO REMOVE (2) SECURITY SCREWS FROM VALVE STEM TO GAIN CLEARANCE FOR VALVE BODY ROTATION FOR INSTALLATION OF DRAIN VALVE.
4. ADD LOCTITE 242 (PROVIDED) TO THREADS AND ROTATE SST CAP OR VALVE BODY UNTIL SECURE WITH VALVE STEM ON LEFT SIDE AS SHOWN.
5. RE-INSTALL HANDLE WITH (2) SECURITY SCREWS TO VALVE STEM.
6. ADJUST THE CABINET ON THE BENCH WITH A 2" OVERHANG AND SEAL INTERFACE WITH BENCH TOP USING RTV SILICONE SEALANT.

FIGURE - 3

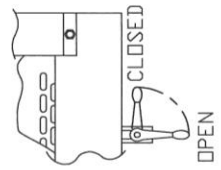

3.0 Warranty

Details regarding product warranties can be found in the published warranty data separate from this manual and included within the data packet sent with the unit.

4.0 Shipments

Nuaire takes every reasonable precaution to assure that your LabGard® ES cabinet arrives without damage. Motor carriers are carefully selected and shipping cartons have been specially designed to insure your purchase. However, damage can occur in any shipment and the following outlines the steps you should take on receipt of a Nuaire LabGard® ES cabinet to be sure that if damage has occurred, the proper claims and actions are taken immediately.

4.1 Damaged Shipments

- 4.1.1** Terms are factory, unless stated otherwise. Therefore, it is important to check each shipment before acceptance.
- 4.1.2** If there is visible damage, the material can be accepted after the driver makes a notation on the consignee's copy of the freight bill. Then an inspection must be made to verify the claim against the carrier. This inspection is the basis of your filing the claim against the carrier.
- 4.1.3** If concealed damage is found, it is absolutely necessary to NOTIFY THE FREIGHT AGENT AT ONCE, and request an inspection. Without this inspection, the transportation company may not accept a claim for loss or damage. If the carrier will not perform the inspection, an affidavit must be prepared stating that he was contacted on a certain date and that he failed to comply with the request. This along with other papers in the customer's possession will support the claim.

5.0 Installation Instructions

5.1 Location

Within the laboratory, pharmacy, etc., the ideal location of the Biosafety cabinet is away from personnel traffic lanes, air vents (in or out), doors and/or any other source of disruptive air currents.

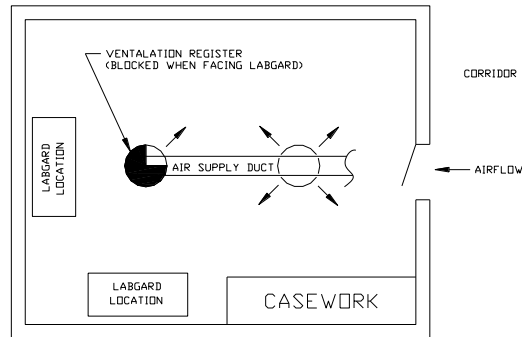

Suggested Cabinet Location in Laboratory

THE EXHAUST FILTER AREA IS ESPECIALLY SUSCEPTIBLE TO DISRUPTIVE AIR CURRENTS FROM AIR VENTS. The exhaust sensor for the Electronic Airflow Control System is located just above the exhaust HEPA filter and if disruptive air currents are present, the exhaust sensor could be influenced by them, and indicate disruptive readings on the front panel display.

If drafts or other disruptive air currents exceed the inflow velocity of the cabinet through the access opening, the potential exists for contaminated air to exit or enter the work zone area of the cabinet. It depends on the severity of the air current. REMEMBER: A BIOSAFETY CABINET IS NO SUBSTITUTE FOR GOOD LABORATORY TECHNIQUE.

Where space permits, a clear 6" (152mm) area should be permitted on each side of the cabinet for maintenance purposes. The electrical outlet into which the cabinet is connected should be readily accessible for maintenance purposes. **Do not position the cabinet to prevent access to the power cord.** The power cord plug serves as the disconnect and should remain readily accessible. If the outlet is inaccessible, such as a conduit (hardwired) connection, then an appropriate warning label should be applied near the cabinets on/off switch to indicate the circuit breaker on the power distribution panel should be used. A MINIMUM CLEARANCE OF 6" (152MM) IS REQUIRED FROM THE TOP OF THE CABINET TO THE CEILING FOR PROPER VENTILATION OF THE EXHAUST EFFLUX.

If this cabinet is used in a pharmacy application, it is strongly recommended **(Per OSHA, NIOSH and ASHP) that the cabinet be exhausted to the outside.** In addition, if this cabinet is used in microbiological application with minute quantities of volatile toxic chemicals and trace amounts of radionuclides, **per CDC/NIH and NSF, it is strongly recommended that the cabinet be exhausted to the outside.** Nuair offers a canopy type of exhaust transition, which will capture the exhaust efflux from the cabinet.

Canopy, Thimble or Air Gap Exhaust Transitions.

 **Note:** The Exhaust System should be fitted with a backdraft damper to prevent reversing of airflow in the system.

 **Note:** Some countries (i.e. Germany) only allow canopy or thimble type transitions. Verify requirements per Local, State and Federal code laws.

5.2 Set-Up Instructions

Remove outer shipping protection (carton or crating). The cabinet is fastened to the base skid and it is usually the best procedure to leave the skid in place until the cabinet is located in its approximate position to facilitate ease in handling. It can then be removed from the skid by removing the banding, bolts and screws holding the cabinet to the skid. It may be necessary to remove the control center in order to gain passage through a doorway. It can easily be removed by following the instructions on drawing BCD-16301.



It is recommended that no less than two people are present using a lifting system for placement of the cabinet onto the base stand. It is not recommended to manually lift the cabinet onto the base stand.

5.2.1 Base Stand Assembly

The base stand is typically shipped knocked down in a separate carton and is assembled per drawing BCD-16633. Once assembled; place the stand in approximate position (ready for cabinet placement onto the base stand). Now lift the cabinet on top of the base stand and bolt the base stand to the cabinet using two 3/8" - 16 x 3/4" bolts and washers provided for the front base stand tabs and two 1/4" acorn nuts for the rear weld studs. Place the cabinet in the desired location.

5.2.2 Leveling

Using a level placed on the work tray, first adjust the leg levelers end to end and then front to back. The NSF approved leg levelers provide a $\pm 3/4"$ (20mm) adjustment.

5.2.3 Bench Installation (BCD-16882)

Place the cabinet on the bench with approximately a 2" (51mm) overhang clearance for the drain SST cap or security drain valve. If the security drain valve is not desired, leave the SST cap in place and place the cabinet in its desired location and using RTV caulk, seal all around the base of the cabinet and the bench. This provides a tight seal to prevent bench spills from migrating under the cabinet.

If the security drain valve is desired, (**NOTE, CHECK WITH YOUR SAFETY PERSONNEL FOR REGULATORY REQUIREMENTS (i.e. LOCKING TYPE) OF DRAIN VALVE INSTALLATION**) remove the handle from the valve stem with security tool provided to gain clearance for valve body rotation. Add Loctite 242 (furnished) to the threads and rotate valve body until secure, with the valve stem (for handle) on the left side. Re-install handle to valve stem. Adjust the cabinet on bench to provide a 2" (51mm) overhang and seal the interface of the bench and cabinet, using RTV caulk as above.

5.2.4 Gas Service

Nuair doesn't recommend the use of natural gas within the LFBSC, but if gas service is determined to be necessary for the application, appropriate safety measures must take place. All Nuair LFBSC's have precautionary warning labels that say the following:

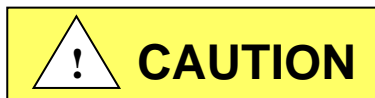

Use of explosive or flammable substances in this cabinet should be evaluated by your appropriate safety personnel.

Once the determination has been made by the appropriate safety personnel, the application of natural gas must be performed in accordance to national, state and local codes. **IT IS ALSO STRONGLY RECOMMENDED THAT AN EMERGENCY GAS SHUTOFF VALVE BE PLACED JUST OUTSIDE THE LFBSC ON THE GAS SUPPLY LINE.**

The gas valve, when this option is installed, will only operate or flow gas when the cabinet blower is on and no alarm is present. A solenoid valve is installed on the gas supply line for this purpose.

 **NOTE: Some countries (i.e. Germany) only allow certain types of certified valves to be used for natural gas (i.e. Germany DVGW Certified). Verify requirements per Local, State and Federal codes/laws.**

As previously stated Nuair doesn't recommend the use of natural gas within the LFBSC and ASSUMES NO RESPONSIBILITY FOR ITS USE. USE AT YOUR OWN RISK. The Bunsen burner flame within the LFBSC not only contributes to heat build-up; it also disrupts the laminar air stream, which must be maintained for maximum efficiency. IF THE PROCEDURE DEMANDS USE OF A FLAME, A BUNSEN BURNER WITH ON DEMAND IGNITION IS STRONGLY RECOMMENDED. DO NOT USE CONSTANT FLAME GAS BURNERS. During use, the Bunsen burner should be placed to the rear of the workspace where resulting air turbulence will have a minimal effect.

5.2.5 Plumbing Services

Service ball valves with the type of service specified by the removable button on the handle are located in the work zone. The service ball valves are not recommended for pressure over 75 p.s.i. (5.2 BAR). Reducing valves should be installed external to the cabinet if necessary. Service ball valves should never be used for flammable gasses or oxygen service. A special needle valve for oxygen service or certified valve is required and available upon request.

External connection is to 3/8 inch NPT coupling in the inner sidewalls. Connection to plant utilities should be made with proper materials for the individual service and according to national and/or local codes. Observe all labels pertaining to the type of service and operating pressure.

5.2.6 Electrical Services

The NU-545E series Biosafety Cabinets may be "hardwired" (optional) or plugged into an outlet with protective earthing connection with the standard power cord. The cabinet requires 230 VAC, 50/60 Hz, single phase (current rating varies per cabinet size, reference Electrical/Environmental Requirements). It is recommended that power to the cabinet, whether hardwired or plug connected, be on its own branch circuit, protected with a circuit breaker at the distribution panel near the cabinet. **A surge protector is strongly recommended** if you are experiencing power related faults.

 **NOTE: THIS CABINET CONTAINS ELECTRONIC BALLASTS FOR THE LED LIGHTING. ELECTRONIC BALLASTS OPERATE WITH HIGH INRUSH CURRENT. IT IS NOT RECOMMENDED TO USE THIS PRODUCT WITH GROUND FAULT CIRCUIT INTERRUPTERS (GFCI'S) BECAUSE THE BALLASTS MAY CAUSE THE GFCI TO TRIP.**

5.2.7 Final Assembly

 **NOTE: Remove the protective cardboard cover over the exhaust HEPA filter.**

Remove the protective cardboard cover over the exhaust HEPA filter located under the protective screen if in place. The exterior surface and viewing glass are easily cleaned with any mild household detergent cleaner using a soft cloth. Harsh chemicals, solvent-type cleaners and abrasive cleaners should not be used.

Do not attempt to clean the HEPA filter media. Cabinet interior walls or work surface are easily cleaned with any mild household detergent cleaner using a soft cloth. Turn the cabinet on and let it operate for 60 minutes before using it as a LFBSC.

5.3 Testing Methods and Equipment

After installation and prior to use, Nuair recommends that the cabinet be tested or commissioned to factory standards. As part of testing, the certifier should go through the following initial checklist to assure all aspects of the LFBSC installation are complete and ready for testing.

- Review product installation
 - Exhaust connection, if present
 - Damper valve installed correctly, if present
 - LFBSC base stand level
- Verify Airflow Sensor shroud is in place
 - Downflow
 - Exhaust flow
- Perform LFBSC certification
 - At a minimum, the following tests should be performed:
 - HEPA filter leak test
 - Downflow velocity test
 - Inflow velocity test
 - Airflow smoke patterns
 - Site installation assessment tests

The testing methods and equipment required are specified on the factory inspection report included with this manual (see insert in back cover).

 **NOTE: IT IS RECOMMENDED THAT THESE TESTS BE PERFORMED BY A QUALIFIED TECHNICIAN WHO IS FAMILIAR WITH THE METHODS AND PROCEDURES FOR TESTING BIOSAFETY CABINETS (SEE INSERT).**

 **NOTE: AFTER THE INITIAL CERTIFICATION, NUAIRE RECOMMENDS THAT THE CABINET BE RECERTIFIED AT A MINIMUM OF AN ANNUAL BASIS AND AFTER EVERY FILTER CHANGE, MAINTENANCE ACTION, OR ANY TIME THE OPERATOR FEELS IT IS NECESSARY.**

Note that the LabGard® ES cabinets, filters and seals provide premium performance; Quality Control in both design and manufacturing assure superior reliability. However, protection to both product and operator is so vital that installation testing to the performance requirements should be accomplished as stated to ensure Biosafety established by the factory standards.

**LabGard® ES Energy Saver Class II
Laminar Flow Biosafety Cabinet
Models NU-545-300E, 400E, 500E, 600E**

Catalog Number	Catalog Number			
	NU-545-300E Nominal 3 foot (0.9m)	NU-545-400E Nominal 4 foot (1.2m)	NU-545-500E Nominal 5 foot (1.5m)	NU-545-600E Nominal 6 foot (1.8m)
Performance Specifications 1. Personal Protection 2. Product Protection	NSF/ANSI 49 EN 12469	NSF/ANSI 49 EN 12469	NSF/ANSI 49 EN 12469	NSF/ANSI 49 EN 12469
EN 12469 Class	Class II	Class II	Class II	Class II
Style of Cabinet	Bench top/console w/base stand/storage cabinet	Bench top/console w/base stand/storage cabinet	Bench top/console w/base stand/storage cabinet	Bench top/console w/base stand/storage cabinet
Cabinet Construction	All welded stainless steel 16GA, Type 304 pressure tight design	All welded stainless steel 16GA, Type 304 pressure tight design	All welded stainless steel 16GA, Type 304 pressure tight design	All welded stainless steel 16GA, Type 304 pressure tight design
Diffuser for Air Supply (Metal)	Non-flammable	Non-flammable	Non-flammable	Non-flammable
HEPA Filter Seal Type: Supply Filter-99.995% Eff. on 0.3 microns Exhaust Filter-99.995% Eff. on 0.3 microns	HEPEX Seal Neoprene, Spring-loaded	HEPEX Seal Neoprene, Spring-loaded	HEPEX Seal Neoprene, Spring-loaded	HEPEX Seal Neoprene, Spring-loaded
Fumigation : Automated per EN 12469, Annex J Procedure	Yes	Yes	Yes	Yes
Standard Services: Service Coupling (3/8 inch NPT) Gas Valve/Service Coupling (3/8 inch NPT) Outlet	One, Right Sidewall One, Right Sidewall Two, Backwall	One, Right Sidewall One, Right Sidewall Two, Backwall	One, Right Sidewall One, Right Sidewall Two, Backwall	One, Right Sidewall One, Right Sidewall Two, Backwall
Optional Services: Gas Cocks 3/8" NPT Ultraviolet Light Standard/Cup Sinks	Up to 3 ea. Sidewall One, Backwall Left or Right Work Surface	Up to 3 ea. Sidewall One, Backwall Left or Right Work Surface	Up to 3 ea. Sidewall One, Backwall Left or Right Work Surface	Up to 3 ea. Sidewall One, Backwall Left or Right Work Surface
Cabinet Size Inches (mm): Height (Fully Assembled) Height (Minimum for Transport) Width Depth (with Control Center) And Armrest Removed	60 7/8 (1546) 59 (1499) 41 5/8 (1057) 32 1/4 (819)	60 7/8 (1546) 59 (1499) 53 5/8 (1362) 32 1/4 (819)	60 7/8 (1546) 59 (1499) 65 5/8 (1669) 32 1/4 (819)	60 7/8 (1546) 59 (1499) 77 5/8 (1972) 32 1/4 (819)
Work Access Opening Inches (mm): Standard Opening Height/Optional Standard Inflow Velocity	10 (254) 105 FPM (.53 m/s)	10 (254) 105 FPM (.53 m/s)	10 (254) 105 FPM (.53 m/s)	10 (254) 105 FPM (.53 m/s)
Work Zone Inches (mm): Height Width Depth measured at 10 inches (254 mm) window height	28 1/2 (724) 34 3/8 (873) 26 (660)	28 1/2 (724) 46 3/8 (1178) 26 (660)	28 1/2 (724) 46 3/8 (1178) 26 (660)	28 1/2 (724) 70 3/8 (1788) 26 (660)
Viewing Window Inches (mm): Standard is safety plate sliding glass	Fully closed to 18 (457) open	Fully closed to 18 (457) open	Fully closed to 18 (457) open	Fully closed to 18 (457) open
Required Exhaust Canopy Variable Range (NU-911) Canopy Fixed Range (NU-907/916)	CFM (CMH) 276-501 (649-851) 320 (544)	CFM (CMH) 363-588 (617-1000) 426 (724)	CFM (CMH) 451-676 (766-1149) 531 (902)	CFM (CMH) 538-763 (915-1297) 634 (1077)
Plant Duct Static Pressure Eng./Metric H ₂ O	0.05-0.1"/1.27-2.54mm	0.05-0.1"/1.27-2.54mm	0.05-0.1"/1.27-2.54mm	0.05-0.1"/1.27-2.54mm
Heat Rejected, BTU, Per Hour (not vented)	903 120	1140 157	1768 198	1854 198
Electrical: (CE): Volts, AC 50/60 Hz +Amps: Blower/Lights Amps: Each Outlet Amps: Total 12 ft. Power Cord (one)	230 2.3 3 8 14 GA - 3 Wire, 15A	230 2.9 3 10 14 GA - 3 Wire, 15A	230 4.5 3 11 14 GA-3 Wire, 15 A	230 4.8 3 11 14 GA-3 Wire, 15 A
Crated Shipping Weight:**** Net Weight	460 lbs. /209 kg. 410 lbs. /186 kg.	530 lbs. /240 kg. 480 lbs. /218 kg.	620 lbs. /281 kg. 570 lbs. /258 kg.	690 lbs. /313 kg. 640 lbs. /290 kg.
Sound Pressure Level per ISO 4871***	Not to Exceed 55 dbA ■	Not to Exceed 56 dbA ■	Not to Exceed 58 dbA ■	Not to Exceed 60 dbA ■

+ Based on cabinet with new filters running at 230VAC.

**** Crated shipping weight does not include weight for accessories or options.

***Uncertainty is K = 2 dbA, measurement performed per ISO 11201 in normal running mode.

■Reference the customer test report for procedure and results.

6.0 Operating the NU-545E

6.1 TouchLink™ Control System

6.1.1 Overview

The Biosafety Cabinet Control (BSCC) system is designed to service the control requirements of the NU-545E Biosafety Cabinet. The control system is a self-contained microprocessor driven module that will perform the following functions:

- Easy user interface via **TOUCHLINK** LCD
- Control DC ECM motor/blower via solid state DC motor controller
- Monitor, display and control downflow, via digital dual thermistor airflow sensor
- Monitor and display exhaust flow (inflow) via digital dual thermistor airflow sensor
- Alarm setpoints, high/low for error conditions (downflow and exhaust flow)
- Date/Clock display and timer function
- Control lights via solid state switch
- Control outlets via solid state switch
- Complete diagnostic functions

The NU-545E TOUCHLINK Control system offers the latest dual microprocessor design technology for improved cabinet performance and safety. The control system uses a digital dual thermistor airflow sensor in the downflow stream to monitor and control airflow to setpoints. The control system automatically compensates for filter loading, voltage variances and other environmental effects. A second digital dual thermistor airflow sensor in the exhaust airstream monitors for inflow velocity. Both downflow and inflow are displayed on the **TOUCHLINK** LCD screen. The control system also monitors the sliding window position with a micro switch for both window high, low and window closed positions.

The control system through the use of the front panel controls the on/off function of the LED and ultraviolet lights (optional), outlets and DC ECM motor/blower. The control system also allows contact closure outputs for interaction with HVAC systems to optimize environmental performance.

User interface to the BSCC system is accomplished via the **TOUCHLINK** LCD. Basic use of the BSC is accomplished via the icons located along the top of the screen as shown below. Touch an icon to turn on/off functions as indicated. Each icon will illuminate with color to indicate when the function is turned on. The menu icon will always prompt a menu screen to display. Selecting a menu item will continue the prompts until the desired parameter is achieved. To return to the main menu screen, press the MENU icon repeatedly to reverse out of the parameter menus. To return to the home screen, press the home icon.

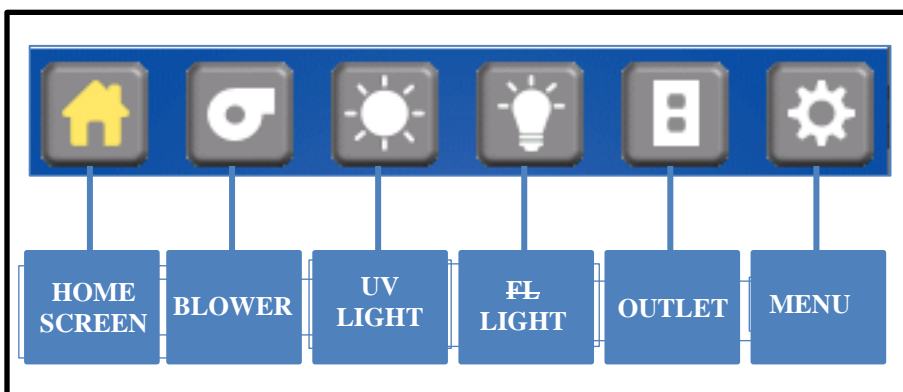

6.1.2 Standby Mode

When the BSC is not in use, the **TOUCHLINK** LCD screen will display Standby, the icons along the top and the time and date at the bottom as shown below. Any of the function icons, except the blower, that initiates Run Mode, may be turned on and off in standby mode. The menu icon may also be accessed for additional user menus.

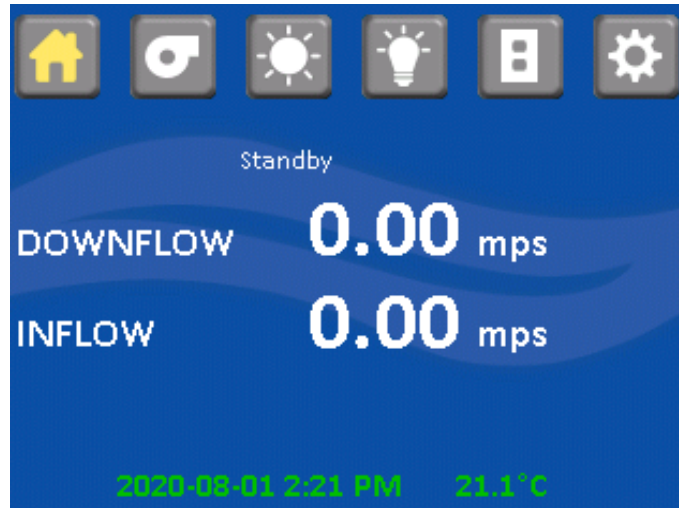

6.1.3 Run Mode

Any time the blower icon is selected the password menu will appear. The default password is "1234". The Run Mode screen will display airflow setpoints and warm up with a 2 minute countdown timer. However, the aseptic cleaning process may begin if the sliding window is raised an audible and visual alarm will occur but may be silenced by pressing the alarm silence icon that appears. Once the warm-up period is complete, airflow readings and all system functions will operate and be displayed.

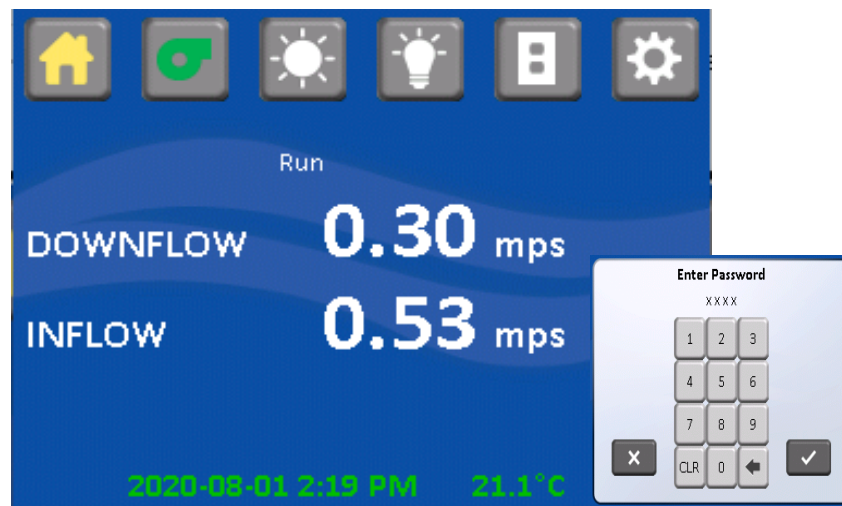

6.1.4 Night Setback/ Nite Care Mode

The NU-545E may be optionally configured to allow the DC ECM motor to continue to run at a lower rate with the sliding window closed allowing the workzone interior to be continually HEPA filtered. If the night setback mode is configured, the blower icon must be on and the window closed for it to be activated. In addition, the light will be disabled. If the sliding window is then opened the cabinet will resume normal airflow setpoints in run mode.

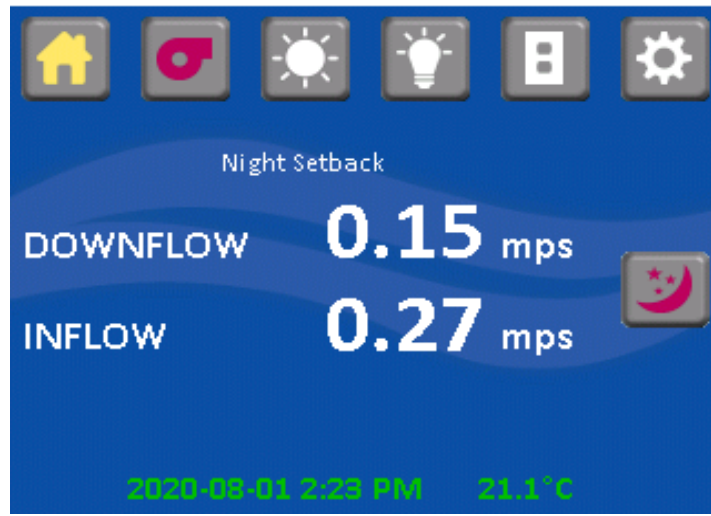

6.1.5 Standby/Run Mode Alarms

If present standby/run mode alarms will be both visual and audible, the Red LED oval under the LCD display will turn on, and the **TOUCHLINK** LCD screen will also display a description of the alarm. Audible alarms can be silenced or will produce an alarm tone for 10 seconds, then into a ring back cycle of once every 2 seconds. Pressing the alarm silence icon will silence the audible alarm for 15 minutes then into a ring back cycle of once every 2 seconds

Alarm Types

The middle of the display just below the icons is the message area that will indicate alarms, errors or other notable conditions. Since the message area is limited to one line of text, only the highest priority message will be indicated. However, for alarm conditions, also displayed is a caution symbol and pressing it will display all present alarm conditions. The list below represents the highest to lowest priority.

- Runtime Failure
- Power Loss Alert
- Downflow Sensor Error
- Inflow Sensor Error
- Exhaust Sensor Error
- Downflow Sensor Communication
- Inflow Sensor Communication
- Exhaust Sensor Communication
- Downflow Low Limit
- Downflow High Limit
- Inflow Low Limit
- Inflow High Limit
- Exhaust Low Limit
- Exhaust High Limit
- Cabinet Pressure Low
- Window High
- Window Low
- Replace Filter
- Replace UV Lamp
- Recertification Past Due
- Recertification Due In (x) Week(s)

6.1.6 Menu Icon

The menu icon, when pressed will provide a list of menu items for various TouchLink functions.

6.1.6.1 Setpoint /Limits:

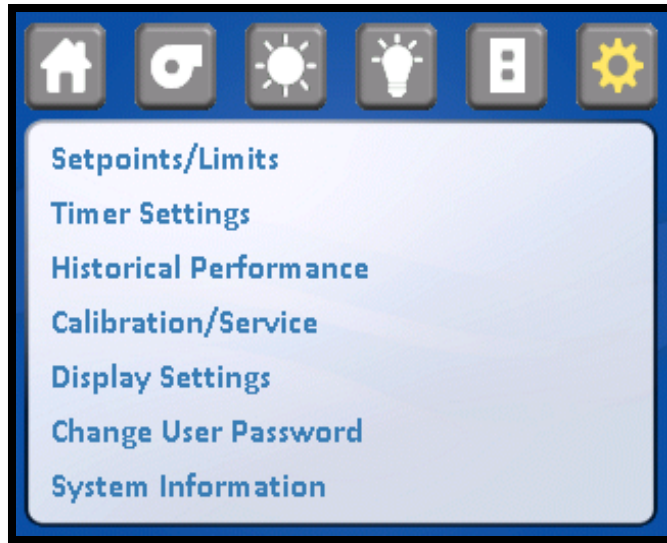

Setpoint /Limits:

This menu screen will indicate the Biosafety Cabinet airflow control setpoints, Access is restricted to service personnel requiring a service password to change values.

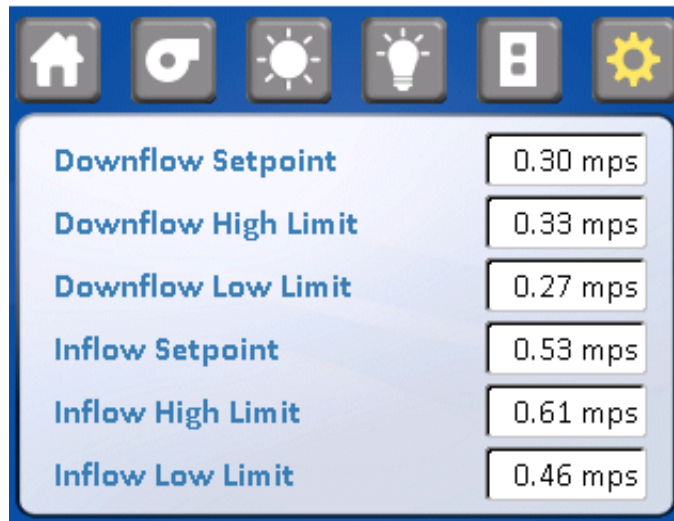

6.1.6.2 Timer Settings:

This menu screen indicates functional timer options. A description of each timer function is provided below. Pressing the time area on the menu will bring up a keypad for time entry for each function.



Timer Functions

- **Purge Timer:** This timer controls how long the blower will run to purge the cabinet after the blower icon has been pressed to turn OFF the blower

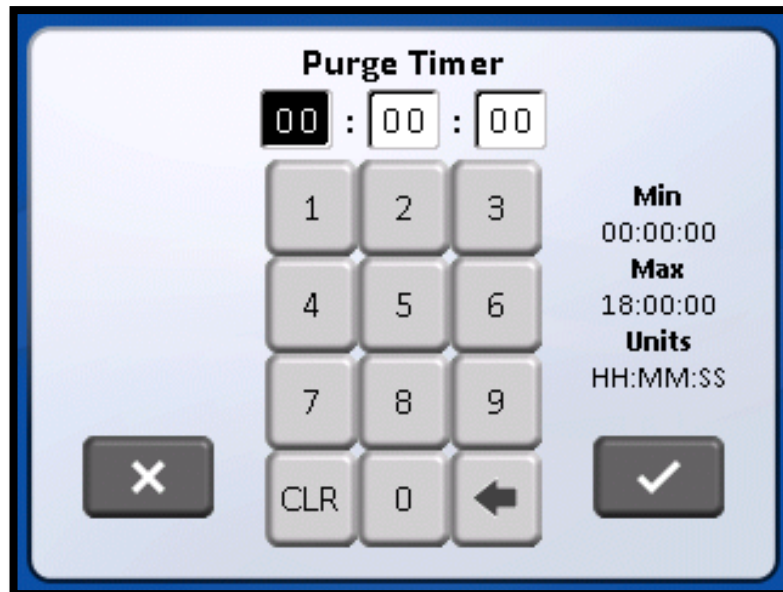

- **Outlet Timer:** This timer controls how long the outlet remains on after the outlet icon has been pressed to turn on the outlet. If timer is zero, the outlet will stay on until turned OFF.

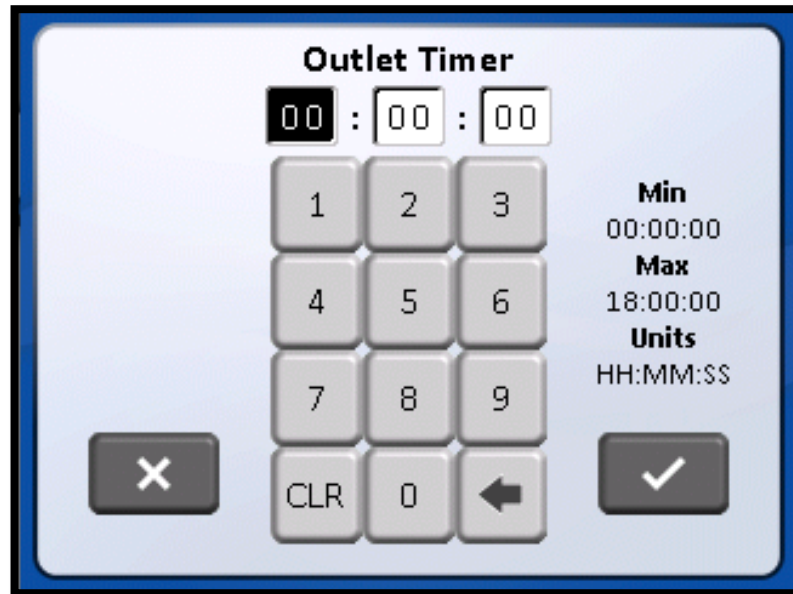

- **UV Light Timer:** This timer controls how long the UV light will remain on after the UV light icon has been pressed to turn on the UV light. If timer is zero, UV light will stay on until manually turned off or window is opened breaking the safety interlock

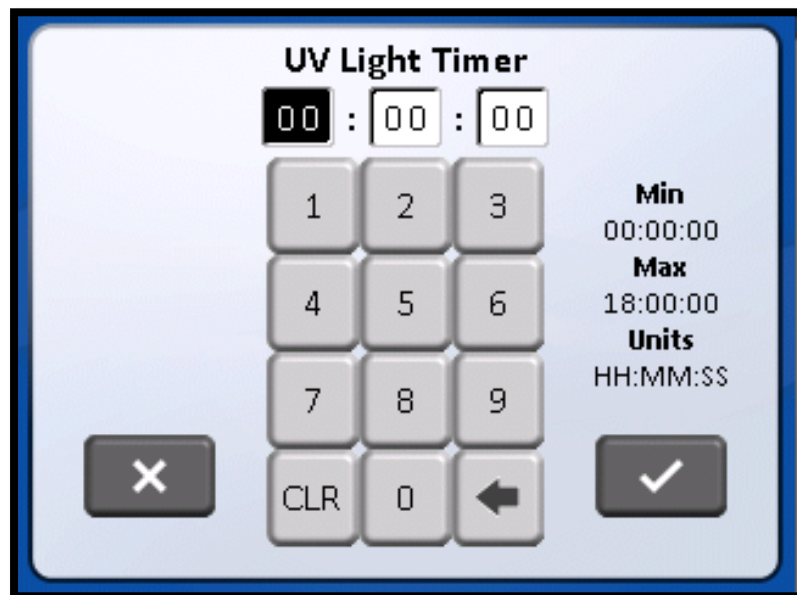

- **Auto Run Timers:** This timer provides the ability to program on a daily basis the start and stop time of the cabinet. To start and stop the cabinets menus that both the blower and LED lights will automatically turn on and off together on a programmed schedule. Once into the auto timer menu, select the desired day for the auto timer to function. If multiple days are desired, each day will be required to be set individually.

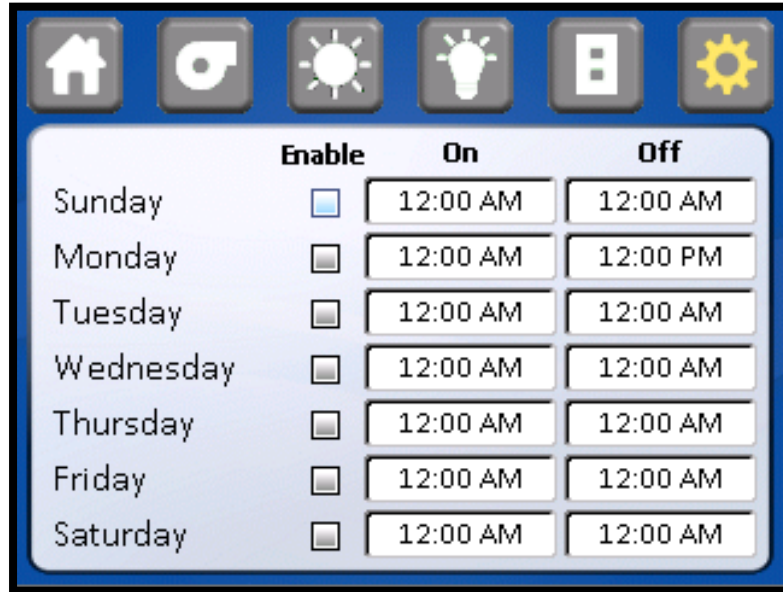

Once into the selected day, press on window to enter the on/off times. Use the keypad to enter hours or minutes. Press menu icon SAVE after each time entry. Repeat auto timer function for each day as desired.

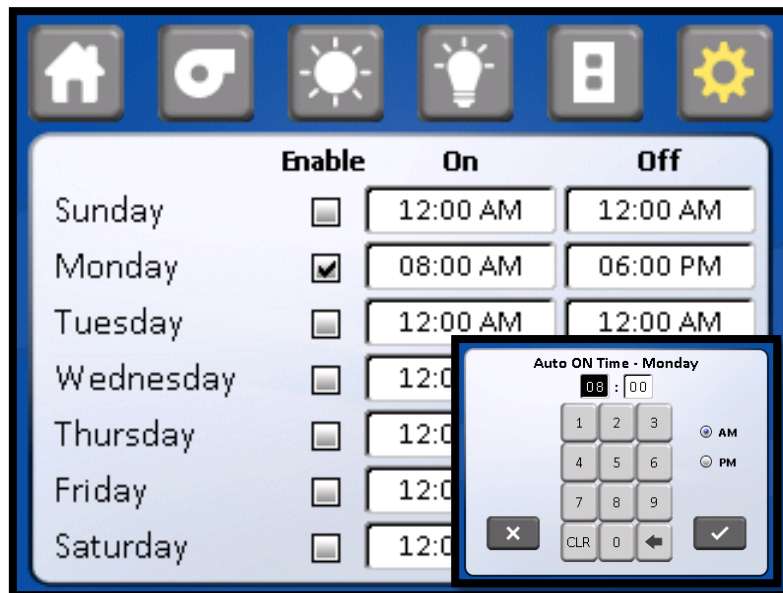

6.1.6.3 **Historical Performance:**

When press a historical performance text, the system displays downflow and inflow history

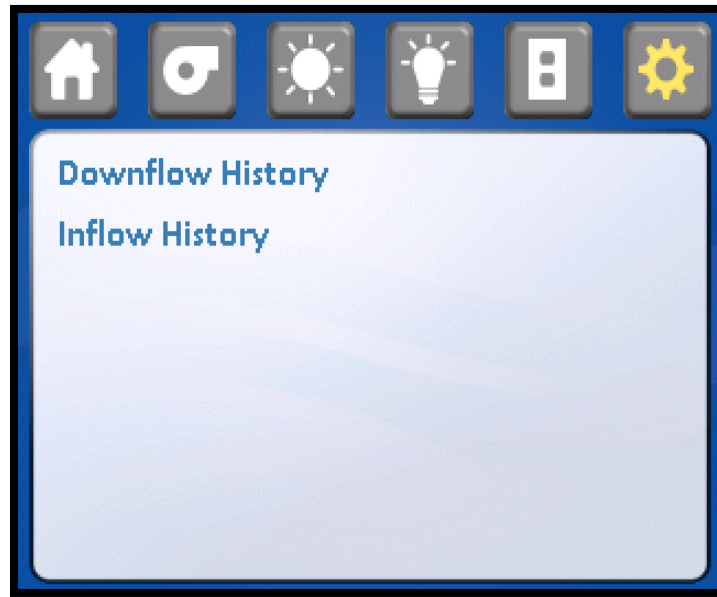

Downflow History: press downflow history, the system displays the week log data in graphical form of downflow versus days.

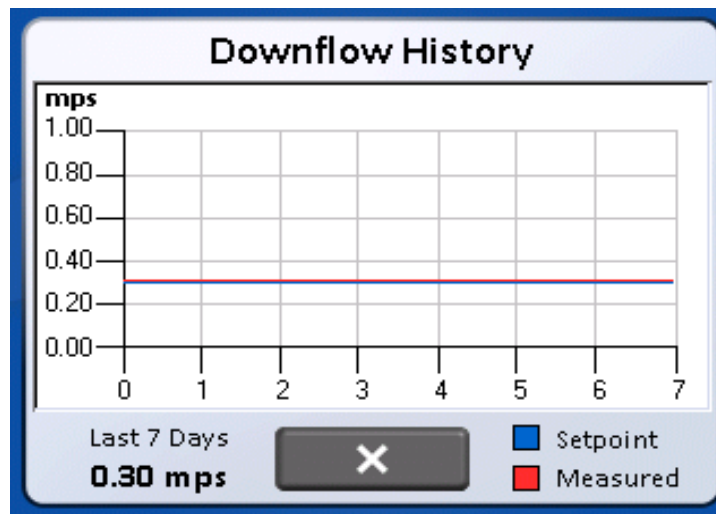

Inflow History: press downflow history, the system displays the week log data in graphical form of Inflow versus days

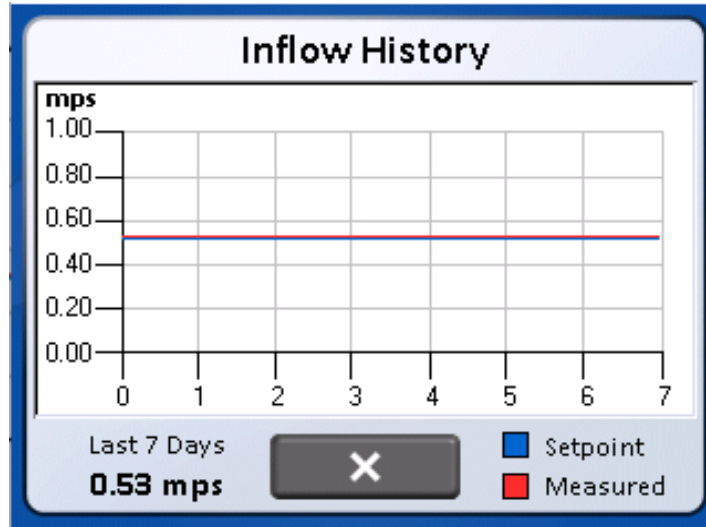

6.1.6.4 Display settings:

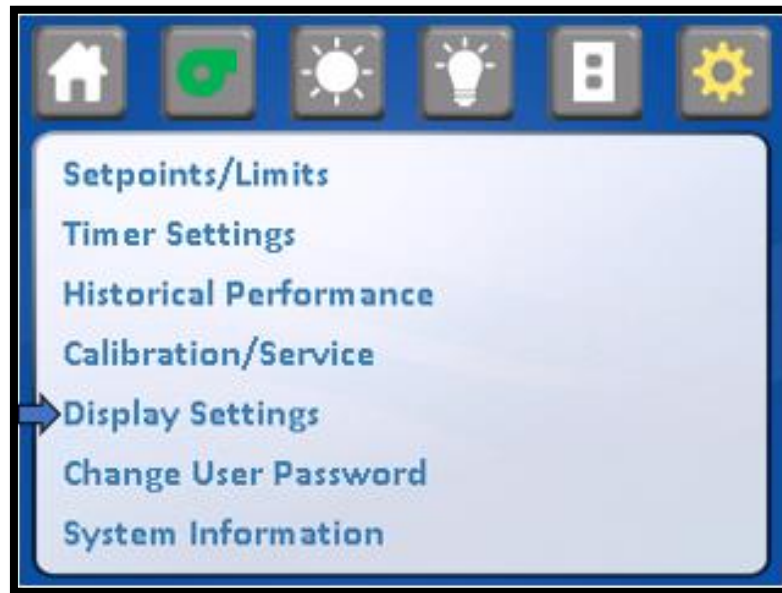

This menu item provides the ability to alter display features and set date/time. Display Background colors of

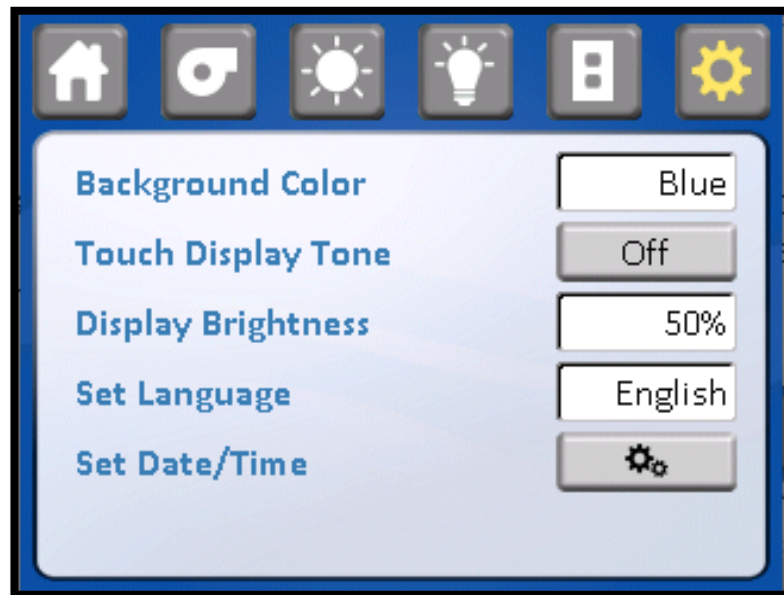

White, Green, Blue and Gray can be selected. Touch display tone audible feedback can turn on/off. Display brightness can be adjusted. Languages may be selected of English, Spanish, French and German.

- Time/Date: This menu item provides the ability to set the time and date displayed on the LCD screen. Time displayed is real time and will not automatically adjust for day light saving time.

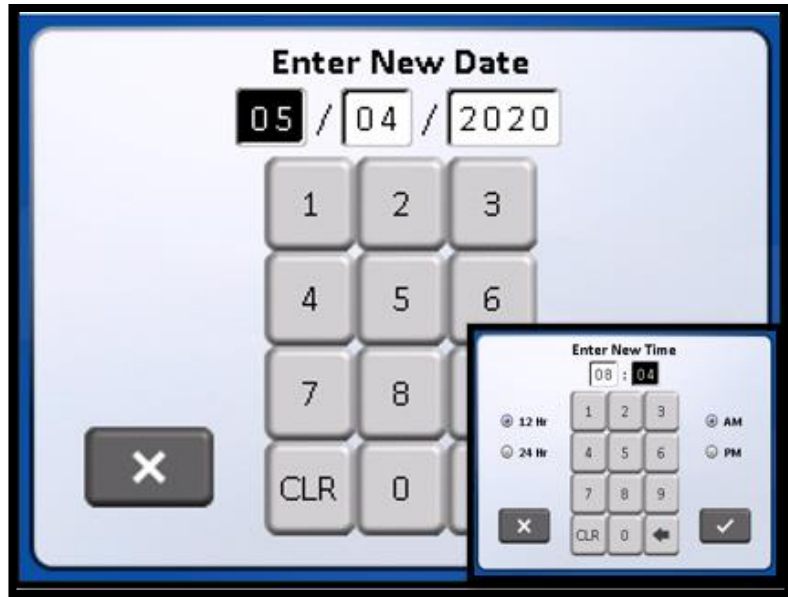

6.1.6.6 Change User Password

This menu item provides the ability to change the user password from the default value of 1234.

- Set Password: Enter Old Password

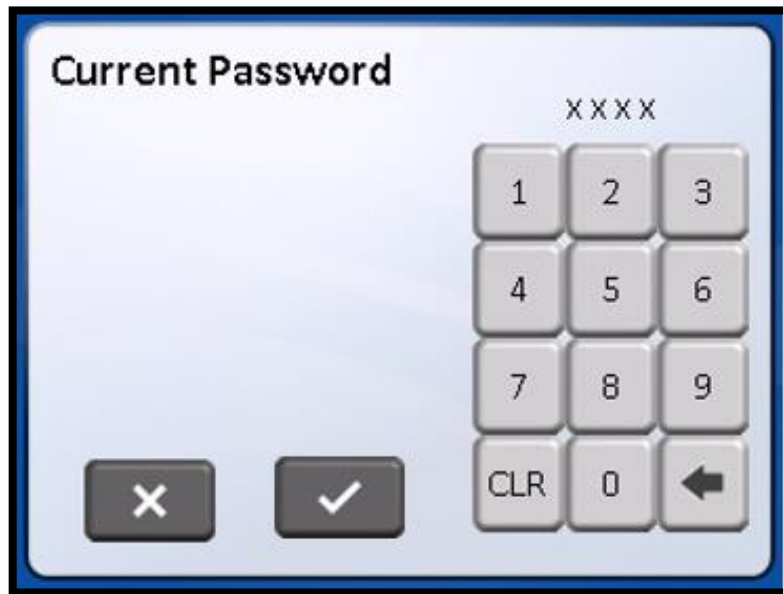

- Set New Password



Create Password
Enter a new 4 digit password.

XXXX

1	2	3
4	5	6
7	8	9
CLR	0	←

✕ ✓

The image shows a 'Create Password' screen with a 4-digit password field (XXXX) and a numeric keypad. The keypad includes buttons for digits 1-9, 0, CLR, and a back arrow. There are also buttons for cancel (✕) and confirm (✓).

- Retype new password



Verify Password
Retype new 4 digit password.

XXXX

The new password will only become enforced if it can be verified.

1	2	3
4	5	6
7	8	9
CLR	0	←

✕ ✓

The image shows a 'Verify Password' screen with a 4-digit password field (XXXX) and a numeric keypad. The keypad includes buttons for digits 1-9, 0, CLR, and a back arrow. There are also buttons for cancel (✕) and confirm (✓). A note states: 'The new password will only become enforced if it can be verified.'

6.1.6.7 system information

This menu item provides the cabinet model number, serial number, and software revision.

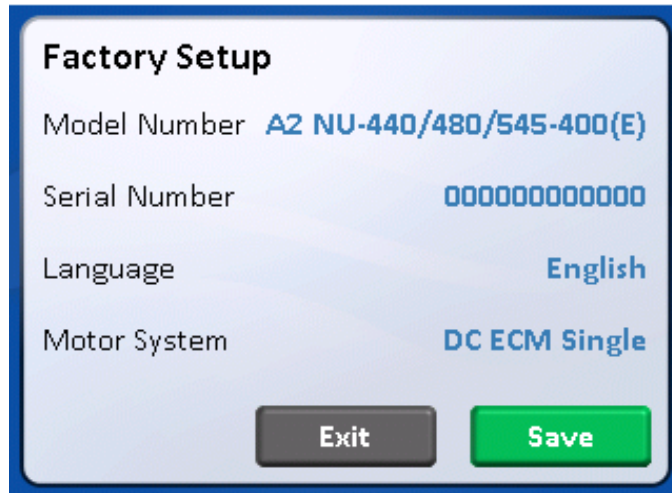

6.1.7 Power Window Option

The power window option, if purchased, is factory installed and the display will indicate window up and down icons on the lower right side of the display. The power window function uses a 24 Vdc motor and internal feedback encoder to determine position. The power window also incorporates a safety auto-reverse feature to eliminate any pinch hazard.

Operating the power window is performed by pressing either the UP or DOWN window icon. The travel is determined by the length of time the icon is pressed. A short press and release will make the window move a short distance. A long press and release will make the window move to the next standard operating point of either closed, nominal work access height of 10 inches (254mm) or full open. The power window if desired can be lowered during the decontamination process for sealing purposes after the armrest is removed.

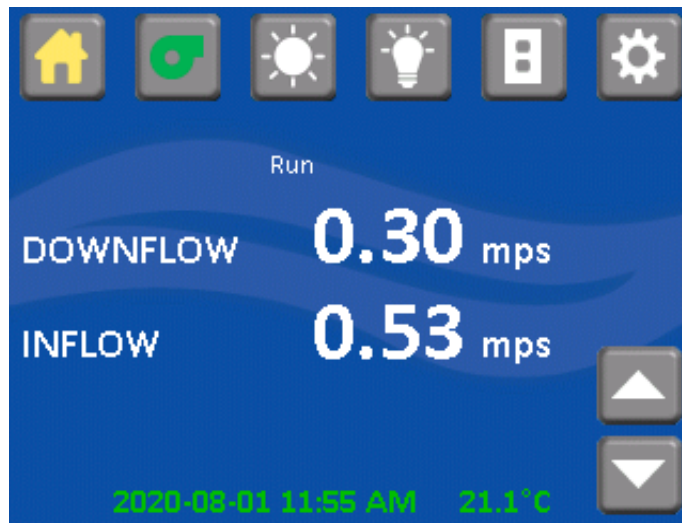

6.2 Operating Guidelines

The intent herein is to present general operational guidelines that will aid in the use of the Laminar Flow Biosafety Cabinet (LFBSC) to control airborne contaminants of low to moderate risk as stated in Technical Report Number FPS 5650000001, prepared by Dow Chemical U.S.A. for the National Cancer Institute, May 1, 1972.

Procedure protocols defined in terms of the barrier or control concepts unique to LFBSC must be developed in order to obtain a maximum potential for safety and protection. The pre-planning necessary to develop these protocols is based on several fundamental considerations, each of which will contribute to optimum benefits from the equipment:

- a. Know you "Safe Work Area"
- b. Minimize disruption of "air curtain"
- c. Minimize room activity
- d. Utilize unidirectional airflow
- e. Employ aseptic techniques

6.2.1 Know about your "Safe Work Tray Area"

The LFBSC safe working area is basically the work tray or depressed area. All work should be performed on or above the work tray. The area on or above the front grill is a non-safe working area.



NOTE: It is important to maintain an air gap on both sides of the work tray before fastening in place. The work tray as being part of the cabinet system has been designed to load up to 100 lbs. (45.4 kg) of work materials. Any additional loading should be evaluated by appropriate safety personnel.

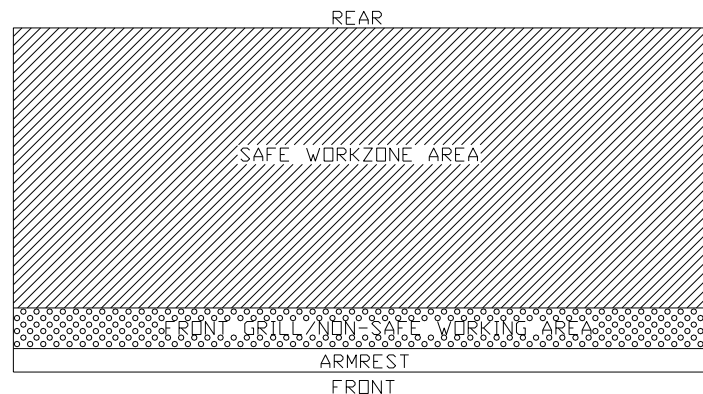

6.2.2 Minimize Penetration of "Air Curtain"

The minimum number of items necessary should be placed into the cabinet to prevent overloading, but the work should also be planned to minimize the number of times an operator's hands and arms must enter and leave the air curtain at the open face. The ideal situation is to have everything needed for the complete procedure placed in the hood before starting, so that nothing need pass in or out through the air barrier at the face until the procedure is completed. This is especially important in working with moderate risk agents.

Unnecessary raising of the hands inside the cabinet above the level of the work opening should be avoided. This presents an inclined plane from hands to elbows along which the downflow of air may run to, and possibly out, the open face.



NOTE: When working with agents of lower risk, it is not as important for all materials to be placed in the cabinet before starting, or for the procedure to be completely finished before materials are removed. Also, the time period for cabinet may be continued over a more extended period during which entries and withdrawals from the cabinet may be made.

6.2.3 Minimize Room Activity

Activity in the room itself should be held to a minimum. Unnecessary activity may create disruptive air currents as well as interfere with the work of the operator. A person walking past the front of a cabinet can cause draft velocities up to 175 fpm (.89 m/s), which are sufficient to disrupt the air balance of the laminar flow cabinet.

6.2.4 Utilize Unidirectional Air Flow

The operator must keep two important facts in mind: (1) The air, as supplied to the work area through filters from the top, is contaminant free and (2) Airborne contamination generated in the work area is controlled by the unidirectional flow of parallel air streams in a top-to-bottom direction.

A solid object placed in a laminar air stream will disrupt the parallel flow and consequently, the capability of controlling lateral movement of airborne particulates. A cone of turbulence extends below the object and laminarity of the air stream is not regained until a point is reached downstream, approximately equal to three to six times the diameter of the object. Within the parameters of this cone, particles may be carried laterally by multidirectional eddy currents.

Transfer of viable materials and manipulations, which may generate aerosols, should not be performed above sterile or uninoculated materials. Items should be localized on the work surface in "clean" and "dirty" groups.

6.2.5 Employ Aseptic Technique

The operator must not assume an attitude of "let the cabinet do it" when performing procedures within a LFBSC. Properly balanced and properly used cabinets will do an excellent job of controlling airborne contamination and containing viable agents, but the cabinet will not eliminate contact transmission of contamination. Normal laboratory contamination control procedures and basic aseptic techniques are necessary to obtain maximum benefit from the cabinet. For example, open bottle, tube or flask mounts should be kept as parallel as possible to the downflow to minimize capture of chance particulates. This precaution is merely an extension of good aseptic technique as practiced on open bench tops. The good laboratory practices designed to minimize creation and/or release of aerosols to the environment should not be discontinued.

Items of equipment in direct contact with the etiologic agent must remain in the cabinet until enclosed or until surface decontaminated. Trays of discard pipettes must be covered before removal from the cabinet (aluminum foil may substitute for fabricated covers).

If an accident occurs which spills or splatters suspensions of etiologic agent around the work area, all surfaces and items in the cabinet must be surface decontaminated before being removed.

Applying a burner flame to flask and tube necks when mating surfaces of sterile assemblies is a conventional method of minimizing chance contamination. However, the efficiency of this operation is usually related to the removal of airborne contamination occurring while the item is uncovered. If the manipulation is carried out in an environment free of airborne particulates, then the need for the flaming operation is essentially removed. This is one of the additional advantages of the LFBSC - use of the gas burner is seldom necessary. The gas burner flame in one of these cabinets not only contributes significantly to the heat build-up, it also disrupts the laminar air streams which must be maintained for maximum efficiency. If the procedure demands use of a flame, **A BUNSEN BURNER WITH ON DEMAND IGNITION IS RECOMMENDED. DO NOT USE CONSTANT FLAME GAS BURNERS.** It should also be only used from the center of the work surface to the right rear where resulting air turbulence will have a minimal effect. **DO NOT USE GAS BURNER ON THE LEFT SIDE OF THE WORK SURFACE DUE TO ITS INFLUENCE ON THE ELECTRONIC AIRFLOW CONTROL SYSTEM.** If cabinet air is inadvertently turned off, the flame could damage the HEPA filters.

6.3 Operating Sequence

6.3.1 Start Up

Turn on cabinet blower and lights, check air intake and exhaust portals of the cabinet to make sure they are unobstructed. The electronic airflow control system will automatically control airflows to specified setpoints. However, upon filter loading, the cabinet may be required to be re-balanced or filters replaced. Only a qualified maintenance technician should perform cabinet balancing and filter replacement.

 **NOTE:** Some cabinets are equipped with ultraviolet (UV) lights. Good procedure includes the decontamination or wipe down of cabinet surfaces with chemical disinfectant before work commences. This practice eliminates the need for UV lights, whose primary utility in this application is inactivation of surface contamination since the filters effectively remove all airborne contaminants. UV lights, therefore, are not recommended in the LFBSC.

Allow blowers to operate for a minimum of 15 minutes before aseptic manipulations are begun in the cabinet. If the filtered air exhausted from the cabinet is discharged into the room, as in some installations, an additional advantage is obtained from purification (filtration) of the room air circulated through the equipment. Because of this characteristic contributing to the quality of the laboratory environment, some owners of LFBSC leave them in operation beyond the time of actual use.

6.3.2 Wipe Down

The interior surfaces of the workspace should next be disinfected (see Cleaning Procedures) by wiping them thoroughly with 70% alcohol or similar non-corrosive anti-microbial agents. **USE OF CHLORINATED OR HALOGEN MATERIALS IN THE CABINET MAY DAMAGE STAINLESS STEEL.**

6.3.3 Materials & Equipment

The apparatus and materials should next be placed into the cabinet. Care must be exercised that no items be placed over the front intake grills. Materials should be arranged so that clean, dirty (used), and virus materials are well separated. Passage of contaminated materials over uninoculated cultures or clean glassware should be avoided and transfer of viable materials should be performed as deeply into the cabinet (away from open face) as possible.

6.3.4 Air Purge

Additional purging of the workspace without user activity should be allowed for 2-3 minutes after materials and apparatus have been placed in it. This will rid the area of all "loose" contamination that may have been introduced with the items.

6.3.5 Perform Work

The work can now be performed. The technician performing the work is encouraged to wear a long-sleeved gown with knit cuffs and rubber gloves. This will minimize the shedding of skin flora into the work area and concurrently protect the hands and arms from viable agent contamination. At a minimum, the hands and arms should be washed well with germicidal soap before and after work in the cabinet. For the preparation of antineoplastic drugs, the following procedures summarize those contained in OSHA's guidelines to controlling occupational exposure to hazardous drugs. The above document should be thoroughly studied and reviewed prior to drug preparation in the cabinet. It may be found at this website:

https://www.osha.gov/SLTC/hazardousdrugs/controlling_occex_hazardousdrugs.html.

- a. A sterile plastic-backed absorbent drape should be placed on the work surface during mixing procedures. The drape should be exchanged whenever significant spillage occurs, or at the end of each production sequence.
- b. Vials should be vented with a filter needle to eliminate internal pressure or vacuum.
- c. Before opening ampoules, care should be taken to ensure that no liquid remains in the tip of the ampoule. A sterile gauze sponge should be wrapped around the neck of the ampoule while opening.
- d. Final drug measurement should be performed prior to removing the needle from the stopper of the vial.
- e. A non-splash collection vessel should be available in the Biosafety cabinet to discard excess drug solutions.

6.3.6 Terminal Purging & Wipe Down

Following completion of work, allow the cabinet to run for 2-3-minute period without personnel activity to purge the cabinet. A surface disinfection of the interior surfaces (see Cleaning Procedures section) should be repeated after removal of all materials, cultures, apparatus, etc. A careful check of grills and diffuser grids should be made for spilled or splashed nutrients which may support fungus growth and resulting spore liberation that contaminates the protected work environment.

6.3.7 Paper Catch/Prefilter

A permanent paper catch is installed behind the rear divider panel of the work zone. This area forms the return air path to the motor/blower; and if the airflow is blocked, it could seriously affect the performance of the cabinet. Therefore, **THE PAPER CATCH SHOULD BE CHECKED AND CLEANED NO LESS THAN ON A WEEKLY BASIS**; daily basis if procedures dictate the use of paper products. Any paper removed must be properly disposed of as *Contaminated Hazardous Waste*. The above procedures also apply to all cabinets configured with a prefilter.

6.3.8 Shut Down

Turn off blowers and lights. Do not use cabinet as a depository for excess lab equipment during periods of non-operation. If antineoplastic agents are being prepared in the cabinet, it is recommended to let the cabinet run 24 hours per day. This lessens the possibility that contaminants may escape.

6.4 Ergonomics

Ergonomics, the study or accommodation of work practices is extremely important for proper cabinet usage and user health and safety. An evaluation of normal work practices should be performed with each user when working in a cabinet. Evaluation criteria should be at a minimum:

- a. Proper user posture
- b. Effective work zone layout for work practice
- c. Vision or sightlines

For each of the above evaluation criterion, several work aids may be supplied to accommodate the user.

- Ergonomic chair - A six-way articulating seat and back control for personalized adjustment to assure proper user posture. Be sure feet are resting on the floor, chair foot support or footrest. Also be sure back is fully supported with proper chair adjustments.
- Forearm/elbow support - The cabinet is provided with a non-metallic forearm support on the work access opening. Periodic mini breaks during work practice should be taken resting forearm to avoid stress and fatigue. Elbow rests are optional that can provide support for particular work practices, such as pipetting. Also available as an option, closed cell foam disposable forearm pads to reduce pressure points and add comfort.
- Effective workzone layout - Always prepare your work procedure to minimize reach to avoid neck and shoulder stress and fatigue. Rotating tables are optional to maximum workzone and minimize reach.
- Vision and sightline - Always prepare your work procedure to eliminate glare and bright reflections on the window. Keep your window clean and sightlines clear to your effective work zone.

6.5 Cleaning Procedures

6.5.1 General

Cleaning laboratory equipment is important in terms of both functionality and general good housekeeping. The information provided below is intended to aid the development of facility Standard Operating Procedures (SOP's) for cleaning the equipment. It is strongly recommended that all cleaning materials used be tested and verified in terms of both effectiveness and material compatibility before they are written into the cleaning SOP documentation.

- a. The airflow blower should be operating during the cleaning process to maintain sterility and/or containment during the cleaning process.
- b. Raise window to gain additional access if desired.
- c. Apply appropriate cleaning material or surface disinfectant to surfaces. Most surface disinfectants require a specific contact time depending the materials used within the work zone. **CONSULT APPROPRIATE DISINFECTANT DOCUMENTATION FOR PROPER APPLICATION AND SAFETY PRECAUTIONS.**
 - c-1. Stainless steel (type 304) has noted material compatibility concerns with Acids, Chlorides and Halogens. **IF THESE MATERIALS ARE USED AND ALLOWED TO BE LEFT ON THE STAINLESS-STEEL SURFACE, OXIDATION AND DEGRADATION WILL OCCUR.** Only by re-wiping surfaces with either sterile water or 70% IPA will remove harmful materials from the stainless-steel surface.

Further information is available at the following: http://www.parrinst.com/wp-content/uploads/downloads/2011/07/Parr_Stainless-Steels-Corrosion-Info.pdf

NOTE: Nuair does not offer any product warranty with respect to cleaning material compatibility. **USE AT YOUR OWN RISK!** The information provided above is from raw material suppliers and known general source documents for use to develop application cleaning SOP's.

-  NOTE: When cleaning the work area for the first several times, the new metal surfaces may produce some dark discoloration on the white cleaning wipes. Repeated cleaning will continuously reduce the amount of the discoloration material on the cleaning wipes over time.

6.6 Hazardous Drug Decontamination Procedures

This procedure is intended to provide guidance following a spillage and/or periodic maintenance, testing or relocation of the cabinet. Additional guidance can be provided by the CETA document CAG-005-2007 found at the CETA website: www.CETAinternational.org.

6.6.1 Preparation

Prior to beginning decontamination activity, personnel should wear proper personnel protection equipment (PPE) i.e. Tyvek¹ isolation gown, 2 pair of Nitrile gloves and a full-faced HEPA filtered respirator. All protective garments should be contained in 4 mil plastic bags and labeled for disposal as chemotherapy waste after completion of the procedure. For the purpose of this procedure, detailed procedures for cleaning a Class II BSC can be found in the 2006 ASHP Technical Assistance Bulletin ASHP Guidelines on Handling Hazardous Drugs².

6.6.2 Procedure

- a. Make sure that the cabinet remains in operational mode with internal blower on.
- b. Open the hinged or sliding view screen and secure in the full open position.



With the view screen in the full open position, personnel protection is compromised and a full faced HEPA filtered respirator must be worn.



- c. Clean all readily accessible surfaces of the cabinet.
- d. Remove perforated metal diffuser screen from the underside of the supply HEPA filter and place on the cabinet work tray.

 **NOTE:** Depending on the model, the diffuser screen is secured to the cabinet by #8-32 screws or 1/4" - 20 acorn nuts, 3 places. It is purposely a tight fit and is secured to the back wall with projecting threadless studs.

- e. Clean both sides of the perforated metal diffuser screen and remove it from the cabinet.
- f. Lift the cabinetwork tray, clean both sides and remove it from the cabinet.
- g. Remove the front perforated grill, place on the cabinet floor and clean both sides. Remove from cabinet.
- h. Clean work tray supports.
- i. Working from top to bottom, clean all inside surfaces of the cabinet. Take care **not** to wet the HEPA filter. If liquid has collected in the plenum drain, aspirate it using IV tubing into an evacuated container. Label the evacuated container for disposal as chemotherapy waste.
- j. Clean the plenums drain area and wipe dry.
- k. If the cabinet requires maintenance and/or replacement of the HEPA filters, the operation should be halted at this point to allow trained personnel to complete replacement of the HEPA and/or maintenance action required.

6.6.3 Assembly

- a. Replace front (if removed) grill.
- b. Replace the work tray and carefully tighten the thumbscrews.
- c. Replace perforated metal diffuser screen over the underside of the supply HEPA filter.
- d. Wipe down all exposed surfaces of the work area with 70% isopropyl alcohol.
- e. Prepare for aseptic operation.

7.0 General Maintenance

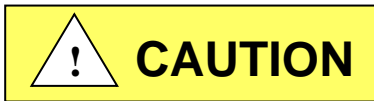

All maintenance actions on this equipment must be performed by a qualified technician who is familiar with the proper maintenance procedures required for this equipment. This includes both certification as well as repair.

7.1 Decontamination

No maintenance should be performed on the interior of the LABGARD ES cabinet (area behind access panels) unless the cabinet has been microbiologically decontaminated, is known to be biologically clean, or known to be chemically inert. Surface disinfection is performed as specified in the Cleaning Procedures section.



Hazardous Gases! Personal Protection Equipment Required.



Decontamination using hazardous gas, vapor or mist must be performed in accordance with the specifications of NSF/ANSI 49, Annex G, EN12469, Annex J or applicable national, state, province or local regulations.

This procedure presents considerable risks and must be performed only by specially trained and authorized service personnel in accordance with applicable national safety regulations (e.g. Germany: TRGS 522).

The decontaminant is generated either external or internal of the sealed cabinet. The quantity of decontaminant should follow standard or manufacturer's recommendations based on cabinet volume. The decontaminant process should follow standards or manufacturer's recommendations based on the decontaminant used.



Flammable Hazard!

All decontaminant materials are hazardous (chemical-liquid, gas and vapor) (Flammable-process) and are required to be handled properly. Follow all product and process documentation and labelling.

The decontamination process can be run as either manual decon process without using the TouchLink system or auto decon process. The auto decon process is started by accessing the CABINET DECONTAMINATION on the calibration /service menu.

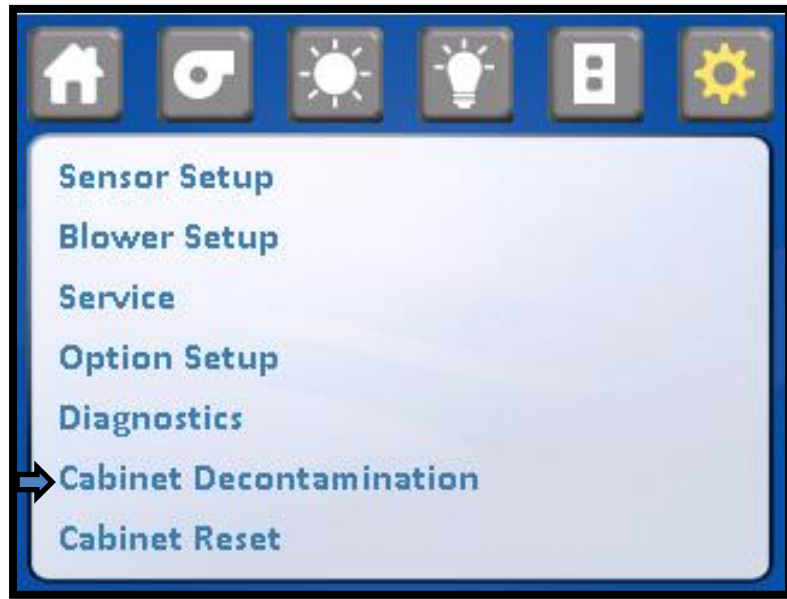

AUTO DECON-H2O2/CD. The Auto Decon process requires the use of Front and Top Seal Plates- Seal plates for BSC's are sometimes part of auto decon process kits from decon process system. Nuairé also offers custom solutions for multiple cabinet sites. Please contact Nuairé Technical Service for further assistance.

7.1.1 Manual Decon

1. Disconnect power to the cabinet. Remove screws at each upper side of the control center and allow the control center to rotate down, resting on the safety straps. Disconnect electrical connectors on left and right sides. (Be sure to note the location of the supply and exhaust sensor wires before disconnecting them from the main board). Remove control center by disconnecting safety straps and moving control center up and out.
2. Remove the top front decorative panel via top/front fasteners.
3. Remove window assembly (both frame and window, either being manual, sliding, or automatic) via the upper and lower fasteners (Refer to BCD-12281). At this point, the sliding window assembly can be removed.
4. Remove exhaust sensor shrouds.
5. Remove the diffuser screen (some methods of manual decon process have been shown to oxidize the diffuser) and gasket around perimeter of workzone.
6. Place decontamination equipment inside the work area. Reference decontamination procedure, per EN 12469, Annex J, using the following chart to calculate chemical requirements

Cabinet Size	300E	400E	500E	600E
Cabinet Dimensions	58-7/8 x 28 x 34-3/8 in. (1.50 x .711 x .873 m)	58-7/8 x 28 x 46-3/8 (1.50 x .711 x 1.18 m)	58-7/8 x 28 x 58-3/8 (1.50 x .711 x 1.48m)	58-7/8 x 28 x 70-3/8 (1.50 x .739 x 1.88 m)
Cabinet Volume	32.79 cu. ft. (.929 cu. m)	44.24 cu. ft. (1.25 cu. m)	55.69 cu. ft. (1.58 cu. m)	67.14 cu. ft. (1.90 cu. m)



BE SURE CABINET IS TOTALLY SEALED TO PREVENT ANY LABORATORY EXPOSURE TO DECONTAMINATION GAS.

Perform decontamination procedure per EN 12469, Annex J

If the cabinet has been used to prepare antineoplastic drugs, (chemotherapy), or other toxic chemicals, decontamination of the cabinet **cannot** be accomplished by the above procedure. It is recommended that the following protective measures be taken:

1. **Gloves**

Gloves must be worn. Care must be taken not to cut, puncture, or tear the gloves. No one glove material is impervious to all CYTAs; disposable surgical or polyvinyl chloride (PVC) gloves provide substantial but not complete protection. PVC gloves probably are more protective than surgical gloves, but they are stiffer and less tactile. Gloves should be discarded after each use. Gloves should be tucked into the cuffs of the gown. Double gloving should be considered.

2. **Face & Eye Protection**

A disposable dust and mist respirator and either a plastic face shield (preferred) or chemical splash goggles must be worn. The face shield or goggles should be wiped clean with a suitable tissue and water after each use.

3. **Gowns**

A protective garment must be worn. The garment should be made of lint-free, low-permeability fabric and must have a closed front, long sleeves, and elastic or knit closed cuffs. Tyvek¹ isolation gowns are one example of an acceptable garment. The garment must be worn outside the work area. Disposable gowns are preferred over reusable. Front-buttoned coats are not recommended.

4. **Hair & Shoe Covers**

Disposable hair and shoe covers should be worn.

5. **Motion**

Slow and deliberate motions are necessary when working in the interior of the cabinet, in order to minimize the generation of particulates.

Please consult with Nuair, Inc. about any unique contamination problems.

Normally, no preventive maintenance is required on the interior of the cabinet (i.e., the area behind the access panel containing the HEPA filters and motor (blower assembly)). All required adjustments in order to maintain proper cabinet airflows are external to the cabinet interior. The motor is lubricated for life and is thermally protected with automatic reset.

¹ Available from Lab Safety Supply, Janesville, WI 53547-1368, or other laboratory, industrial, or hospital supply distributor

7.1.2 Auto Decon

The Auto Decon process is intended to be used with any automated cabinet decontamination process (i.e. hydrogen peroxide, chlorine dioxide, etc.) The automated decon process parameters are typically set up independently of the cabinet. Inlet and outlet ports from the automated decon machine are connected to the cabinet. The cabinet control system may be set up to run simultaneously aiding the decontaminate circulation throughout the cabinet during the entire decon cycle.



To validate two decon processes and associated cabinet set up procedure; Nuair utilized a Bioquell Clarus II H₂O₂ and a Steris X10.

The following process was performed by the Bioquell Clarus II using the LabGard® ES Model NU-543-600E.

1. Remove armrest via fasteners.
2. Remove exhaust shroud and sensor.
3. Seal top and front openings using either heavy plastic and duct tape or seal plates.
Seal all joints with tape as indicated on drawing BCD-16509.

 **Note:** Top and front seal plates may be obtained by contacting Nuair representative or distributor.

4. Attach inlet and outlet connections to decontamination system along with pressure and/or concentration sensor if provided.

REV	ECO	DESCRIPTION	DATE	DFTM	CHKD
D	13035	ADDED ALTERNATE DECON	6/23/2016	TH	DSH

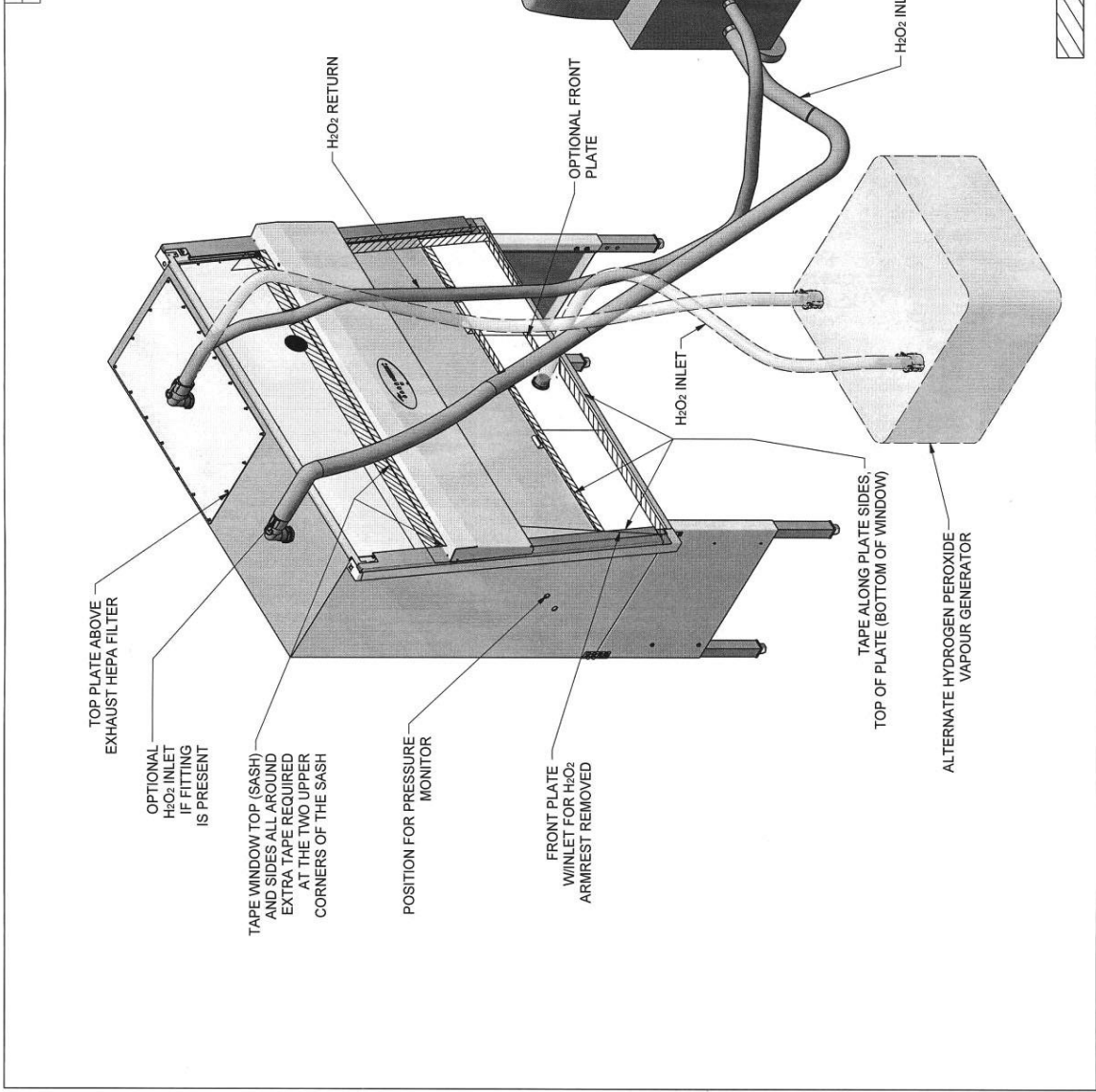

ORIGINAL

TITLE NU-400/500 SERIES, AUTO DECONTAMINATION SETUP				
DFTM	DATE	CHKD	SHEET	OF
JJK	07/28/15	DSH	1	1
DRAWING NUMBER		BCD-16509		
		D		

TAPE

Determine decontamination system cycle parameters.

Note that system parameters will change for process type, as well as cabinet model and size.

For validation purposes, a LabGard® ES Model NU-543-600E was set using the following parameters on the Bioquell Clarus II:

Pressure Setpoint:	-10 Pa
Airflow Setpoint:	22 m ₃ /hr
Delivery Temperature:	65°C
Conditioning Time:	10 min
Gassing Time:	40 min
Gassing Injection Rate:	6.0 g/min
Dwell Time:	90 min
Injection in Dwell:	ON
Dwell Injection Rate:	3.5 g/min
Aeration Delay:	60 min
Aeration Time:	600 min

The following process was performed by the Steris X10 using the LabGard ES Model NU-543-400

1. Blower is turned off.
2. Biological Indicators were placed at the exhaust filter, corner of working area and under the work tray of BSC or anywhere inside the cabinet.
3. Exhaust opening sealed with a metal plate and a tubing connection for the Hydrogen Peroxide (H₂O₂) return.
4. Front opening sealed with plastic film and a tubing connector mounting plate. Reference BCD-16509.
5. Edges of the front window sealed with a low residue tape.
6. Tubing connected to the inlet and outlet of X10.
7. Insertion of Hydrogen Peroxide (H₂O₂) sterilant cup and desiccant cartridge to X10.
8. Current BSC process selected.

Decontamination Process:

9. The X10 will perform one (1) Preheat, Dehumidification, Decontamination and Aeration after start of the program.
10. Preheat – The cabinet is heated to 31° C.
11. Dehumidification – Cabinet is dehumidified to 15% RH.
12. Condition – Sterilant vapor is added to sealed cabinet to target concentration.
13. Checked for any Hydrogen Peroxide (H₂O₂) leakage from the cabinet. Applied extra tape as needed.
14. Decontamination – The cabinet is filled with sterilant vapor for 45 minutes.
15. During the decontamination, the blower was activated for 1 minute every 15 minutes.

Aeration:

16. Aeration – The sterilant vapor is converted to water and oxygen by 3 options
 - a. Connect the exhaust to Fumehood or outdoors
 - b. Connect the AR60 Aerator which catalyzes the Hydrogen Peroxide (H₂O₂) vapor about 3 hours.
 - c. Run Aeration cycle of the X10 for about 10 hours.
17. Check the Hydrogen Peroxide (H₂O₂) level during the Aeration cycle and open the seal when level is less than 1ppm.

Biological indicators were removed and incubated for 7 days.

Auto Decon Set Up

Select AUTO DECON SET UP to enter the specific Decon cycle parameters.



Select DECON FULL CYCLE TIME



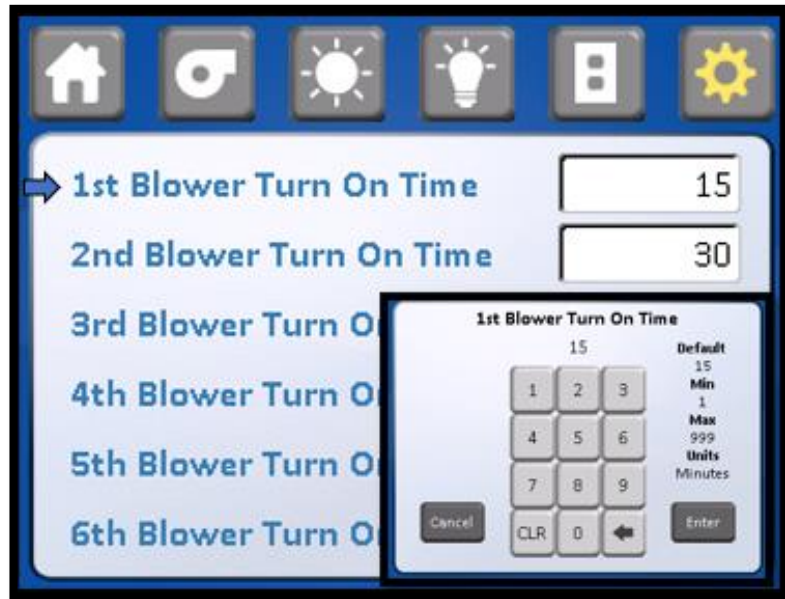

Select and enter blower turn on times and length of blower run time at each interval as required by the automated decon process used. Decon blower duty cycle allows the cabinet blower to run at a lower speed when used during the decontamination process. The default setting has been determined as a minimum value, but adjustments can be made if necessary.



Auto Decon Run

To initiate the auto decon run cycle, select and enter AUTO DECON RUN.

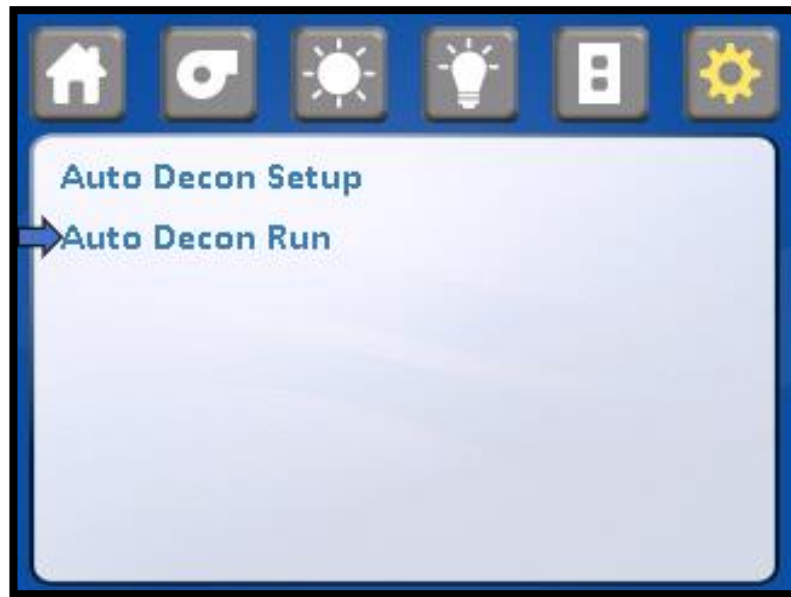

To prevent unauthorized entry into the auto decon cycle, the password must be entered. The password would be the same as the blower password or defaulted with "1,2,3,4".

Once the password has been entered, the procedure screen will appear.

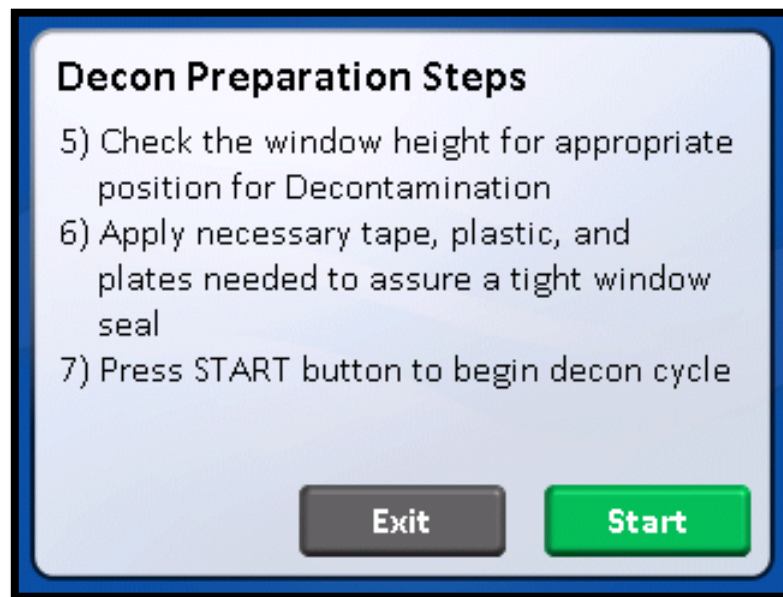

Follow the procedure screen to make final preparations for the auto decon H₂O₂/CD cycle. Once the cycle has started, it is desirable to let the cycle run until finished. The display will indicate what portion of the cycle it's in and the time remaining. It is possible to abort the cycle by pressing cancel. A password screen will appear as verification that the cycle abortion is valid. Enter same blower password or defaulted as "1,2,3,4".

7.2 LED Lamp Replacement

The two (T8) LED lamps are cool white and placed external to the cabinet to aid maintenance and minimize heat build-up within the cabinet. The B70 life rating of the lamp is 50,000 hours based on 80,000 switching cycles.

To replace, it is necessary to remove the lamp assembly.

1. Switch Cabinet Light Switch off.
2. Remove the screws at each upper side of the Control Center and allow the Control Center to rotate down, resting on the safety straps.
3. The lamp is now directly exposed for replacement.
4. The lamp is removed by displacing the lamp to one side against the compressible lamp holder and lifting out the lamp.
5. Reverse the procedure to reinstall the lamp assembly being careful not to pinch the safety straps, cable or tubing during closure of the control center.

7.3 HEPA Filter/Motor Replacement

The HEPA Filters under normal usage and barring an accident (a puncture), do not need replacement until the efflux velocity cannot be maintained or the access inflow velocity cannot be maintained at 100 LFPM (.51 m/s) (min.). This may permit the average downflow velocity to be as low as 55 LFPM (.27 m/s) as long as no point falls below 20% of the average downflow velocity.

The HEPA Filters should not be replaced until the entire cabinet has been decontaminated or known to be biologically "clean".

7.3.1 Procedure

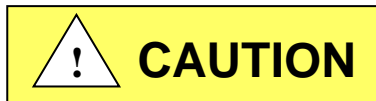

Disconnect electrical power from the cabinet before attempting any maintenance action.

Step 1: Remove screws at each upper side of the control center and allow the control center to rotate down, resting on the safety straps. Second, remove the front decorative panel which is held into position by (3) knurled nuts on the top edge and snap fit bullet catches on the bottom.

Step 2: Place sliding window into lowest position * and remove front filter panel, which is held into position by Phillip pan head screws. Once the screws are removed, the panel is held into position by smooth weld studs located on the top corner of the front filter panel. Use the window stop brackets as handles to remove the panel.

 **NOTE: Screws are used in lieu of acorn nuts, and lock washers.**
The screws have O-rings and should be replaced if damaged or badly deformed.

The interior of the cabinet is now fully exposed for replacement of the filters and/or motor/blower.

*The lowest window position will require the armrest to be removed. If the cabinet has the power window option, access the Power Window Test menu to adjust the power window into its lowest position with the armrest removed. Access Calibration/Service menu, then Service menu, then Power Window menu to Power Window Test.

Step 3: Filter Removal

It is not always necessary to replace both the supply and exhaust filters at the same time. If during the course of certifications, the downflow always falls off while the exhaust increases the supply filter is "loading" faster than the exhaust filter and only the supply filter may need replacement. The opposite might also happen depending upon many factors.

- a. To remove the supply filter:
 1. Remove the plenum screws in front of the supply HEPA filter.
 2. Lift the permanent plenum and hold up with wire strap.
 3. Carefully remove the supply filter. Direct exposure should be avoided.



Dispose of spent HEPA filters properly.

Avoid direct contact to "dirty side" of the filters.

Place in sealed bag and label all waste containers/cartons based on type of hazard. Follow all Local, State and Federal guidelines for disposal of HEPA filter solid waste.

- b. To remove the Exhaust HEPA:
 1. Relax the exhaust filter seal loading mechanism by turning the four threaded bolts counterclockwise until one can see a definite release of the loading springs.
 2. Pull the exhaust choke tray free and remove the filter. It is not necessary to remove the tray, although it is free to move forward several inches, if necessary, to free the HEPA filter.

Step 4: Filter Installation

When installing new filters, **USE ONLY NUAIRE SPECIFIED FILTERS FOR REPLACEMENT.**

(Filters shall conform to EN13091 and EN 1822-1 Class H14)

Description:	Supply HEPA Filter	Exhaust HEPA Filter
Efficiency:	99.995% @ 0.3 Micron	99.995% @ 0.3 Micron
Airflow Rating:	100 fpm @ .65 ± .05" w.g. per sq. ft.	250 fpm @ .48 ± .05" w.g. per sq. ft.
Frame Type:	Metal	Metal

NU-545-300E

Nuaire Part Number:	A-980962-01	A-980962-05
Filter Size:	21" (533mm) x 32" (813mm) x 3" (76mm)	20" (508mm) x 14" (366mm) x 11 1/2" (292mm)
Filter Manufacturer:	Camfil Farr	Camfil Farr

NU-545-400E

Nuaire Part Number:	A-980962-02	A-980962-13
Filter Size:	21" (533mm) x 44" (1118mm) x 3" (76mm)	20" (508mm) x 22" (559mm) x 11 1/2" (292mm)
Filter Manufacturer:	Camfil Farr	Camfil Farr

NU-545-500E

Nuaire Part Number:	A-980962-03	A-980962-14
Filter Size:	21" (533mm) x 56" (1422mm) x 3" (76mm)	20" (508mm) x 30" (762mm) x 11 1/2" (292mm)
Filter Manufacturer:	Camfil Farr	Camfil Farr

NU-545-600E

Nuaire Part Number:	A-980962-04	A-980962-15
Filter Size:	21" (533mm) x 68" (1727mm) x 3" (76mm)	20" (508mm) x 36" (914mm) x 11 1/2" (292mm)
Filter Manufacturer:	Camfil Farr	Camfil Farr

- a. To install the supply filter, simply reverse the procedure outlines in Step 3a, above.

 **Note:** Be sure to open the choke plate fully before inserting the filter into the tray.
This will assist in adjusting the airflow.

- b. To install the exhaust filter, apply a thin layer of silicone grease to the top and bottom gaskets of the filter and carefully insert into the exhaust choke tray.

Position the filter frame within the outside walls of the exhaust opening on the top of the hood.
Tighten the spring loaded bolts, 4 places, depressing the gasket material by 1/8 inch (3mm)

Step 5: Motor/Blower Assembly Removal

- a. It is recommended that the motor/blower to be removed as a single unit. To remove, disconnect electrical connections to the motor, remove the HEPEX pressure plenum and unbolt the motor/blower assembly from the roof of the cabinet (4 places). Always inspect the rubber isolation motor mounts and replace those that are cracked or visibly show stress.
- b. Replace the motor exactly as originally installed in the blower housing, paying particular attention to the correct electrical connections (see Electrical Schematic).
- c. Re-install the new motor/blower assembly.

7.4 Sliding Window Replacement & Manual Adjustment

The sliding window replacement is accomplished by removing the front decorative panel, control center, and window glide assemblies. The sliding window adjustment may be required due to everyday use over the life of the cabinet. Both the right and left window glides are adjustable by a set screw and tension screw method. When adjusting the sliding window, be sure to verify proper micro switch operation. If the sliding window is too loose, the sliding window will not properly activate the micro switches, thus causing potential operational malfunctions to occur. In addition, the sliding window retention or ability to slow the rate of fall, if a window counterbalance experiences a fault, is also required to assure proper window function (see Sliding Window Retention Verification in the Inspection Report).

7.5 Airflow Control System Setup and Calibration

7.5.1 General

The operation of the NU-545E cabinet requires that the setup and calibration procedures be performed in order to certify or commission the cabinet for usage. The setup and calibration procedures performed **ONLY BY THE CABINET CERTIFIER** ensure that cabinet's setpoints are verified and that the airflow monitor sensors are calibrated to read the correct values. Press MENU to access Calibration/Service parameter.

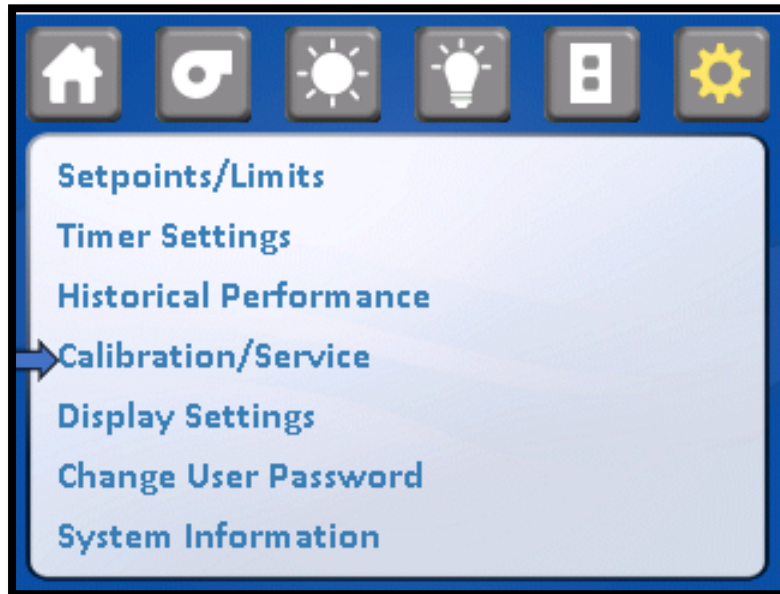

Entry into the Calibration/Service functions requires a service password for entry. After pressing the Calibration/Service menu item, a password screen will appear. The default password is "9876"



Once the service password is entered, the Calibration/Service menu will appear.

7.5.2 Calibration/Service Menu

The Calibration/Service menu provides a list of sub-menu items to accomplish all service tasks. For airflow calibration, only the first three sub-menu items are used in the calibration process.



7.5.2.1 Cabinet Type

The cabinet type can be verified in the control system and is factory set and shouldn't require alteration. The cabinet type default information controls unit of measure, setpoints and limits based on the type and size of cabinet.

To verify, press Service, then Factory Setup to verify the current type of cabinet is correct. If selection or change is required, Press the current model to begin the process. Press cabinet type desired, then Press model desired and lastly Press model size.

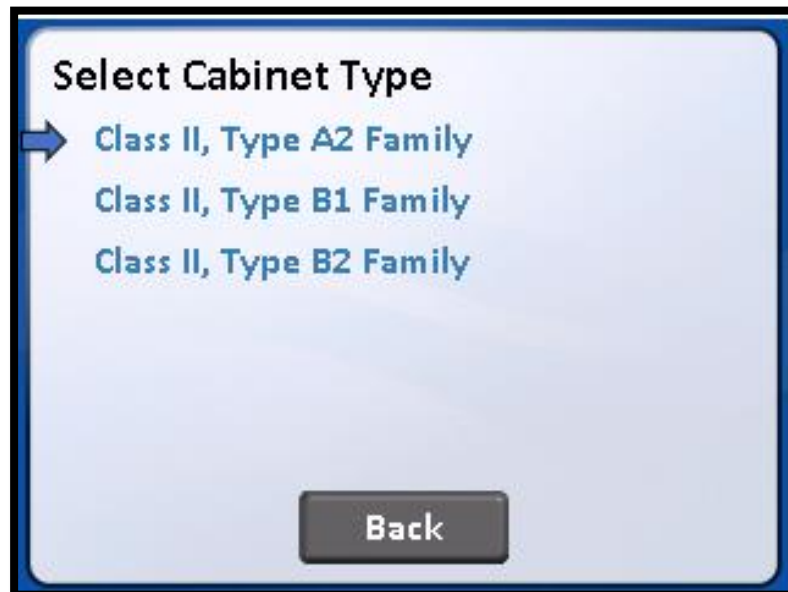

Select Cabinet Model

- A2 NU-440/480/545
- A2 NU-440/480/545(D)
- A2 NU-440/480/545(E)
- A2 NU-481/581
- A2 NU-481/581(E)

Select Cabinet Width

- 3 Feet
- 4 Feet
- 5 Feet
- 6 Feet

Press SET MOTOR TYPE to verify correct setting.
Upon a MASTER RESET, the motor type is defaulted to DC ECM Single.
The NU-545E Series 1 (230Vac) requires the motor type selected to be DC ECM Single.
Always verify motor type when verifying cabinet type.

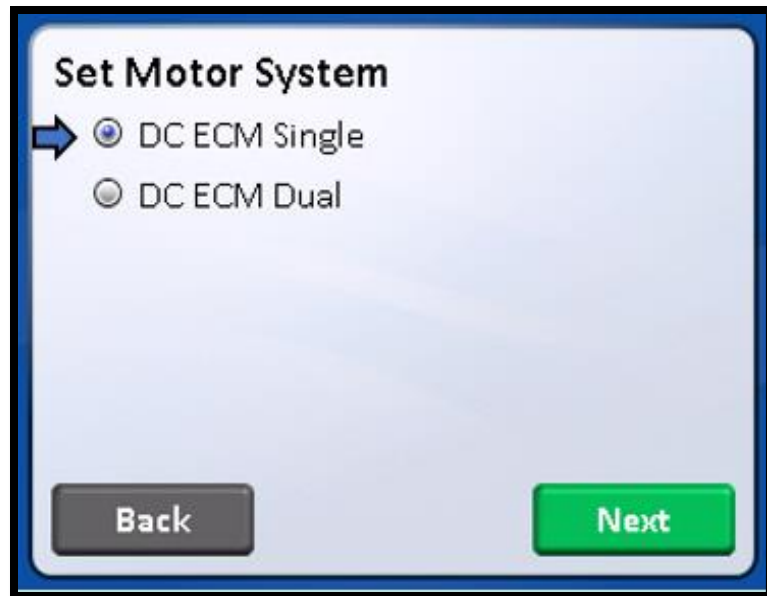

7.5.2.2 Setpoints/Limits

The airflow setpoints and alarm limits may also be verified or altered. Typically, these default values are factory set based on the cabinet type, model and size as previously discussed. However, they may be altered in special cases for modified cabinets. The setpoint establishes the airflow values that are to be maintained. The high low limits establish the alarm boundaries from the nominal setpoint. The default values have been established based upon the performance specifications and cabinet component tolerances.

Entry into the setpoints/limits functions requires a service password for entry. The default password is "9876"

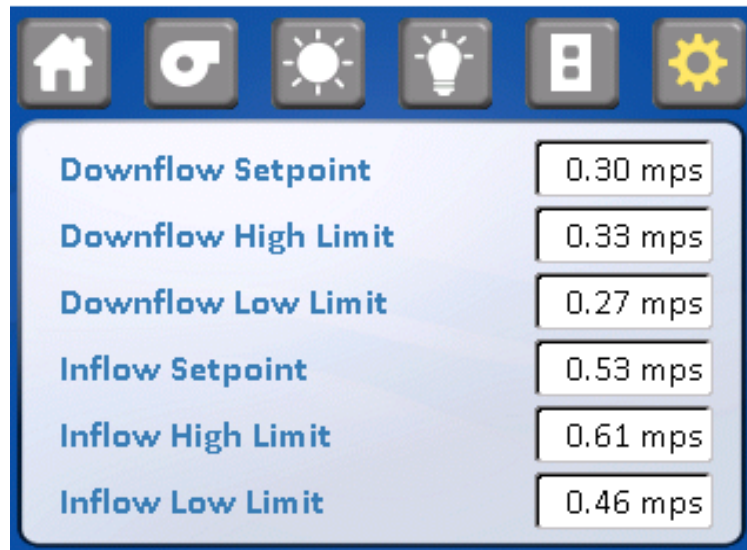

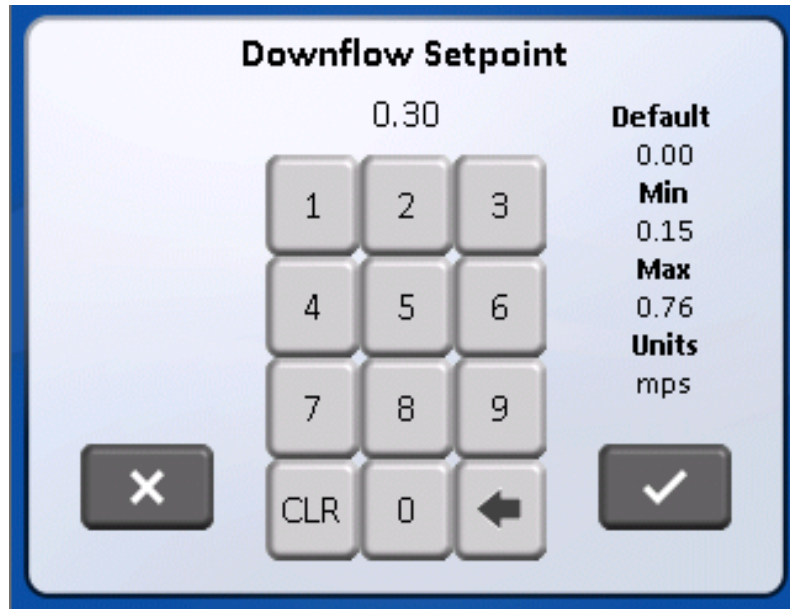

Default values for NU-545E

- Downflow setpoint - .30 MPS
- Downflow high limit - .33 MPS
- Downflow low limit - .27 MPS
- Inflow setpoint - .53 MPS
- Inflow high limit - .61 MPS
- Inflow low limit - .46 MPS

7.5.3 Airflow Calibration

The NU-545E airflow calibration consists of adjustments to balance the airflow within the cabinet and the calibration of the airflow monitor sensors. **THIS WORK SHOULD BE DONE ONLY BY A QUALIFIED TECHNICIAN WHO CAN MEASURE THE AIRFLOW FROM THE FILTERS WITH A SUITABLE VELOMETER.** Nuair provides two adjustments to balance the airflow within the cabinet. These are:

- a. PWM signal adjusts via DC ECM motor control system
- b. Exhaust filter choke

The blower speed control system adjusts the cabinet's total volume of airflow while the choke adjusts or balances the exhaust airflow as well as makes up for filter resistance tolerances. Since it has been Nuair's experience that the filters may not "load" evenly, both adjustments are necessary for proper cabinet performance.

The cabinet is considered to be certifiable if the following airflow measurements are present:

- a. Downflow average: 60 LFPM \pm 5 LFPM (.30 m/s \pm .025 m/s).
- b. Inflow average: 105 LFPM \pm 5 LFPM (.53 m/s \pm .025 m/s) using the Direct Inflow Measurement (DIM) method, or alternate 3" constricted inflow velocity measurement method.

The calibration of the airflow monitor sensors occurs during the cabinet airflow balancing procedure. The calibration procedure consists using the downflow and inflow averages achieved and entry of those values into the control system.

7.5.3.1 Downflow Calibration

- Step 1:
- Access Calibration/Service menu.
 - Enter Password
 - Press SENSOR SETUP menu item to access sensor calibration menu.

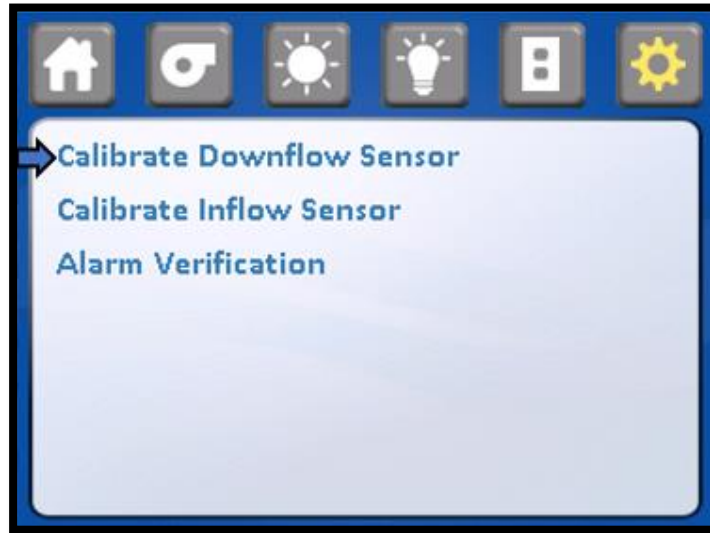

- Step 2:
- Press calibrate downflow sensor. If blower was not running, blower will automatically turn on. Run for one minute or until downflow readings are steady.

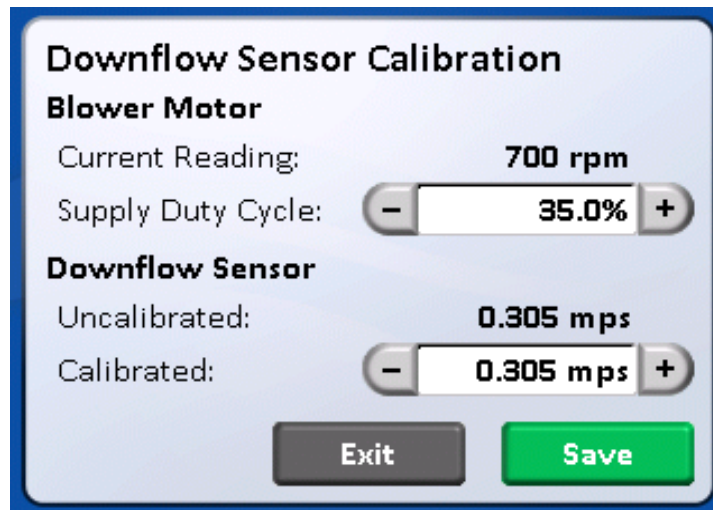

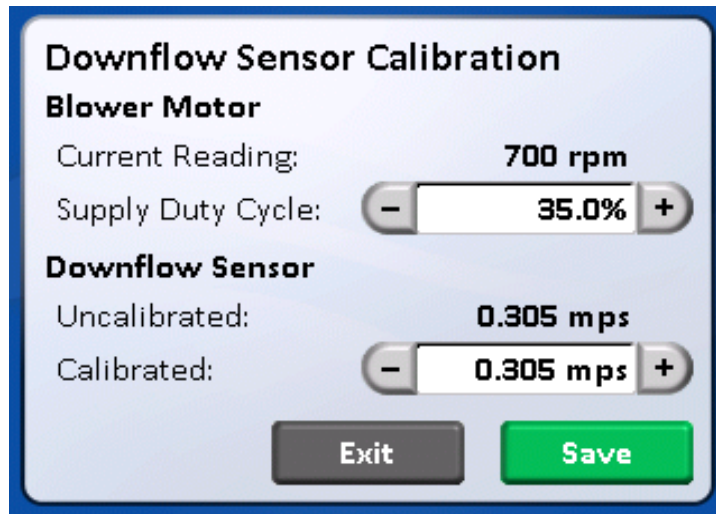

- Step 3:
- Place a velometer in the cabinet workzone on the horizontal plane 4 inches (102mm) above the bottom edge of the window. Spot check several points on the recommended downflow velocity test grid found in table 7.0.
- Step 4:
- Press +/- to adjust supply duty cycle
The objective of this spot check is to obtain the desired downflow average velocity as close as possible to the stated goal of 60 LFPM (.30 m/s).

DON'T SPEND MORE THAN 5 MINUTES SPOT CHECKING.

- Step 5:
- Now, measure the average downflow velocity over the entire workzone using the recommended downflow velocity test grid (see Table 7.0).
- Step 6:
- Press +/- to change the calibrated downflow value to the average downflow velocity just found. Press SAVE to enter the new calibrated downflow value and supply duty cycle (the blower will turn off upon saving the downflow calibration data).
- Now the downflow monitor sensor has been calibrated to the actual measured average downflow velocity. The cabinet will now control to the downflow setpoint.
- Step 7:
- Press Home icon to return to run mode or continue below to inflow calibration

7.5.3.2 Inflow Calibration

NOTE: INFLOW CALIBRATION MUST BE MADE IMMEDIATELY FOLLOWING DOWNFLOW CALIBRATION. THIS ASSURES THE CORRECT BALANCE OF DOWNFLOW TO INFLOW AS RELATED TO THE AIRFLOW MONITOR SENSOR CALIBRATIONS.

- Step 1:
- Access sensor setup menu.

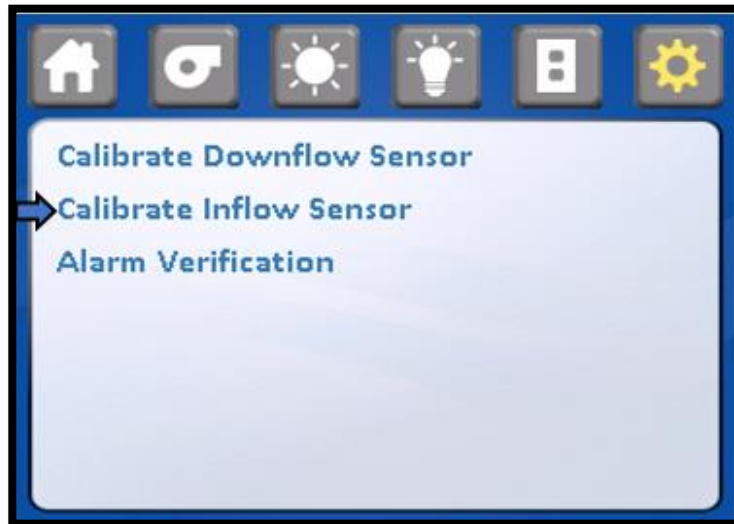

- Step 2:
- Now measure the inflow velocity using the recommended procedure found in Table 7.0.

If necessary, adjust the exhaust filter choke located under the front decorative panel, to achieve the correct average inflow velocity within the stated range of 105 ± 5 LFPM ($.53 \pm .025$ m/s).

IF THE AVERAGE INFLOW VELOCITY IS ON THE OUTER EDGE OF THE RANGE (I.E. 100 or 110 fpm ($.51$ or $.56$ m/s)). IT WOULD BE HIGHLY DESIRABLE TO MOVE IT CLOSER TO THE SETPOINT BECAUSE THE INFLOW MONITOR SENSOR ONLY FOLLOWS THE EXHAUST AIRFLOW OF THE BLOWER SYSTEM Having the inflow calibrated to the nominal setpoint will allow the system to run efficiently and accurately.

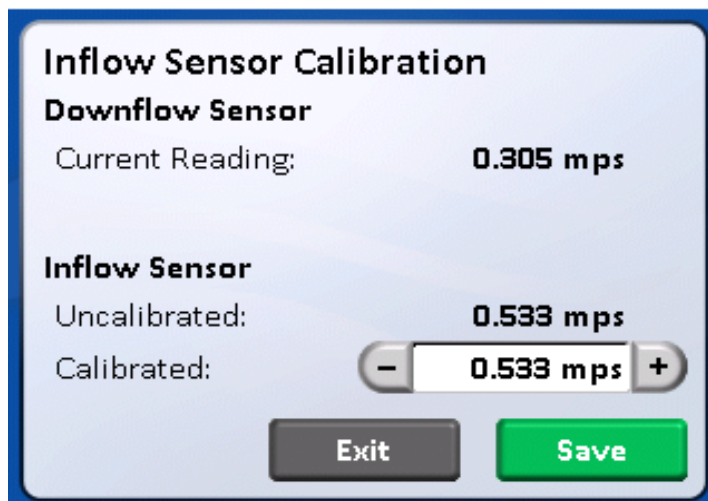



NOTE: The choke plate adjustment requires standard blade screwdriver. To adjust, loosen the liquid-tight fitting around the choke adjustment shaft. While monitoring the exhaust flow to check position, turning the choke adjustment shaft clockwise will open the choke while turning counter clockwise closes the choke.

- Step 3:
- Now the calibration procedure is complete. Return to the Run Mode using the menu icon to back out of the Calibration/Service menu. Press blower switch to initiate the warm-up cycle

Press +/- to change the calibrated exhaust value to the average inflow velocity just found.

Press SAVE to enter the new calibrated inflow value. Press HOME icon to return to run mode.

Now, the calibration procedure is complete. If desired, a spot check in the downflow velocity may be performed if felt necessary.

Once entire cabinet has been balanced, tighten liquid tight fasteners around choke adjustment shaft.

7.5.3.3 Alarm Verification

If desired, the alarm setpoint can be verified by entering into the alarm verification menu.

The airflow alarm is always active in this menu, so if the blower is turned on in this menu, an airflow alarm will activate if the airflow is above or below the alarm limits.

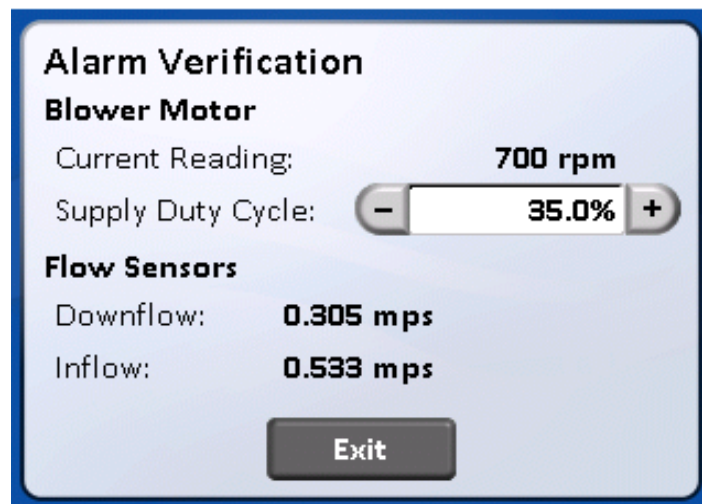

Using the +/- adjust supply duty cycle as necessary to activate a low or high airflow alarm. Measure either downflow (representative point) or inflow at the alarm point to verify limits.

Table 7.0
Recommended Measurement Methods for Cabinet Downflow and Inflow

A. Downflow Measurement

- a. Recommended Instruments: TSI 8355 Thermo anemometer
- b. Procedure: Supply filter efflux is measured on a grid, in a horizontal plane 4 inches (102mm) above the bottom edge of the window. No reading should be taken closer than 6 inches (152mm) from the inside perimeter.
- c. Test Data - Inches (mm):

300E	4.297 (109)	12.891 (327)	21.485 (546)	30.078 (764)
400E	5.797 (147)	17.391 (442)	28.982 (736)	40.578 (1031)
500E	7.297 (185)	21.891 (556)	36.485 (927)	57.078 (1297)
600E	8.797 (223)	26.391 (670)	43.985 (1117)	61.578 (1564)
6.348 (163)				
19.312 (491)				

Number of Readings:	Average Velocity	ft./min.(m/s)
---------------------	------------------	---------------

- a. Acceptance Criteria:
 - 1. Average downflow velocity = **55 to 65 fpm (.28 to .33 m/s)**
 - 2. Individual readings must be within ± 20 percent of the average downflow velocity.

B. Inflow Measurement

- a. Recommended Instrument: Shortridge Flowhood ADM-870 or TSI 8355 Thermo anemometer.
- b. Primary Procedure:
The primary procedure to determine inflow velocity uses a Direct Inflow Measurement (DIM) Instrument (i.e. Shortridge flowhood). The DIM Instrument can be used directly on the cabinet with **NO CORRECTION FACTORS REQUIRED** if operated in the local density default mode. NSF has tested the cabinet and established listed air velocities. Use duct tape to secure the DIM Instrument to the cabinet preventing any sneak air paths from occurring.

The DIM Instrument will read inflow volume (i.e. CFM). Use the window access opening area to calculate inflow velocity.

Alternate Procedure:

The alternative procedure to determine inflow velocity uses a thermo anemometer in a constricted window access opening of 3 inches (76mm) with the armrest removed. Inflow air velocity is measured in the center of the constricted opening 1-1/2 inches (38mm) above the work access opening on the following specified grid. Use the correction factor table to calculate the inflow velocity.

c. Test Data - Inches (mm):

1. DIM Measurement

Inflow Volume ft. ³ /min.(m ³ /s)	Access Opening ft. ² (m ²)	Inflow Velocity ft./min(m/s)
--	--	---------------------------------

2. Constricted 3 inch (76mm) high access opening measurement - Inches (mm):

300E	4 (102)	8.3966 (213)	12.792 (325)	17.188 (437)	21.584 (548)	25.980 (660)	30.375 (771)									
400E	4 (102)	8.264 (210)	12.528 (318)	16.792 (426)	21.056 (535)	25.320 (643)	29.584 (751)	33.848 (860)	38.112 (968)	42.375 (1076)						
500E	4 (102)	8.198 (208)	12.396 (315)	16.594 (421)	20.792 (528)	24.990 (635)	29.188 (741)	33.386 (848)	37.584 (955)	41.782 (1061)	45.980 (1168)	50.178 (1274)	54.375 (1381)			
600E	4 (102)	8.158 (207)	12.316 (313)	16.474 (481)	20.632 (524)	24.790 (630)	28.948 (735)	33.106 (841)	37.264 (946)	41.422 (1052)	45.580 (1158)	49.738 (1263)	53.896 (1369)	58.054 (1475)	62.212 (1580)	66.375 (1686)

Number of Readings:	Average Velocity of Constricted Area ft./min.(ms)
---------------------	--

1.		Average Velocity of Constricted Area	fpm (m/s)
2.	X	Constricted Access Area	ft ² (m ²)
3.	=	Constricted Area Volume	CFM(m ³ /s)
4.		Constricted Area Volume	CFM(m ³ /s)
5.	÷	10" (254) Access Window Area	ft ² (m ²)
6.	=	Average Velocity of 10" (254) Access Window Area	fpm (m/s)
7.		Average Velocity of 10" (254) Access Window Area	fpm (m/s)
8.	X	Correction Factor for Window Height	
9.	=	Average Inflow Velocity	fpm (m/s)

d. Acceptance Criteria: Access Opening Inflow Velocity = 100 to 110 fpm (.51 to .56 m/s)

Areas/Correction Factors for Calculations

Cabinet Size	Window Access Opening		Correction Factor For	
	3" (76mm) Constricted	10" (305mm)	10"(305mm) Window	
300E	.72 (.067)	2.39 (.222)	1.21	
400E	.97 (.090)	3.22 (.299)	1.21	
500E	1.22 (.113)	4.05 (.376)	1.20	
600E	1.47 (.137)	4.89 (.454)	1.15	

7.6 HEPA Filter Leak Test

In order to check filter and filter seal integrity, the HEPA filter media and seals must be directly accessible, by the measuring instrument. The challenge material (i.e. PAO) should be supplied in the rear center of the workzone over the intake slots. The upstream challenge port being common for both filters in located on top of the cabinet.

7.6.1 Supply Filter

The diffuser plate placed below the HEPA to protect the filter during normal usage may be removed as follows: The diffuser is secured to the cabinet shell by #1/4-20 acorn nuts located immediately behind the front viewing window. After removing the fasteners, drop the front of the diffuser plate several inches and pull forward gently. Note that the diffuser is purposely a tight fit - it is held to the back wall of the cabinet interior by a light push - fit with projecting studs. To avoid the window high alarm during the filter integrity check. It is desirable to enter the Calibration/Service menu and turn on the blower.

7.6.2 Exhaust Filter

The exhaust filter is typically more difficult to check since protective grills, charcoal filters, or exhaust transitions could cover the filter. Access panels are usually provided and should be removed. If an air gap exhaust transition is provided, the air gap must be sealed with duct tape or other suitable means to prevent contaminated air from migrating into the exhaust efflux. All exhaust blowers/fans should be turned off during the check. The exhaust sensor shroud can also be removed for the exhaust filter integrity check. Replace the exhaust sensor shroud immediately after the filter check to assure proper operation.

Air currents in the room can sometimes contribute to exhaust entrainment on top of the cabinet. This can lead to false leak readings. In order to reduce the probability of false leak readings it is recommended to cover half of the exhaust HEPA filter while scanning the uncovered section of the exhaust HEPA filter.

 **NOTE:** To avoid the window high alarm during the filter integrity check, it is desirable to enter into the calibration/Service/Sensor Setup/calibrate downflow sensor menu.

 **NOTE:** If the upstream challenge port is deemed contaminated and not accessible, use both downflow and exhaust volume for determining challenge concentrations. Use following area information below with average downflow velocity and spot-check exhaust velocities as measured to determine volume (CFM) (CMH).

<u>Model Size</u>	<u>*Supply Area (ft²)(m²)</u>	<u>Exhaust Area (ft²)(m²)</u>
300E	6.33 (.588)	1.61 (.150)
400E	8.53 (.792)	3.06 (.284)
500E	10.74 (.998)	4.17 (.387)
600E	12.95 (1.203)	5.00 (.465)

* Measured 4 inches above the bottom edge of the window.

Laskin Nozzle Concentration Formula

$$\frac{\# \text{ Nozzles} \times 135 \text{ CFM} \times 100 \text{ ug/L}}{\text{Downflow (CFM)} + \text{Exhaust (CFM)}} = \text{Challenge Concentration (ug/L)}$$

$$\frac{\# \text{ Nozzles} \times 229 \text{ CMH} \times 100 \text{ ug/L}}{\text{Downflow (CMH)} + \text{Exhaust (CMH)}} = \text{Challenge Concentration (ug/L)}$$

7.7 Airflow Smoke Pattern Test

The airflow smoke pattern test is performed using a smoke source (i.e. smoke tubes) in and around the cabinet workzone and access opening to determine a visual representation of the cabinet's containment performance. To perform the test, the smoke source should be passed through the following areas:

1. A smoke source shall be passed from one end of the cabinet to the other, along the center line of the work surface, at a height of 4 inches (102mm) above the top of the access opening.
2. A smoke source shall be passed from one end of the cabinet to the other, 1 inch (25mm) just inside the view screen, at a height 6 inches (152mm) above the top of the access opening.
3. Pass a smoke source along the edges of the entire perimeter of the work opening approximately 1.5 inches (38mm) outside the cabinet, with particular attention paid to corners and vertical edges.
4. Pass a smoke source 2 inches (51mm) from the sides up inside of the window at the side channel seals, and along inside of the cabinet along the top of the work area or immediately below the wiper gasket.

The criteria used to evaluate the smoke patterns is the following:

1. The smoke inside the cabinet shall show smooth downward flow with no dead spots or reflux.
2. No smoke shall escape from inside the cabinet.
3. No smoke refluxes out of the cabinet once drawn in, nor does smoke billow over the worksurface or penetrate onto it.
4. No smoke shall escape from the cabinet.

7.8 Site Installation Assessment Tests

These tests are performed to verify the sash position, airflow or pressure setpoint where an audible and/or visual alarm will activate to signify unfavorable operating conditions within the Biosafety cabinet and/or the remote exhaust blower, and canopy connection performance.

7.8.1 Sash Alarm

- Step 1: With sash alarm switch enabled, raise the sliding sash 1" (2.5cm) above the manufacturer's designated sash height for normal operation. Verify that the audible/visual alarm activates/sounds.
- Step 2: Return the sash to its normal operating height.

Note, if necessary, adjustment of the sash alarm switches can be accomplished by:

Behind the right side faring there is a cover panel that needs to be removed. Then you can access the microswitches and adjust the trip point. Adjustment is not just vertical, but as you see in the following picture, we have allowed tolerance for rotational adjustment too. Sometimes how the window switch roller is positioned will affect its activation point.

Use a nut driver to loosen the switch plate, adjust and re-tighten



7.8.2 Airflow or Pressure Alarm (when installed)

- Step 1: Measure and record the speed control operating voltage at the speed control test points using a voltmeter.
- Step 2: Using the primary or secondary inflow test method, lower the speed control voltage to reduce the inflow by 20% from the certified testing value.
- Step 3: Verify that the alarm activates when the inflow is dropped to this point.
- Step 4: Adjust alarm setpoint as necessary as instructed by the alarm manufacturer procedures.
- Step 5: Return the speed control to its certified operating voltage as measured by the voltmeter.

7.8.3 Exhaust System Performance Canopy Exhaust Transitions

- Step 1: Introduce a visible medium source into the canopy air intake(s) while slowly reducing the exhaust volume until there is a loss of capture of the visible medium into the canopy air intake(s). The audible and visual canopy alarms shall respond within 15 seconds, and the cabinet fan(s) will continue to operate.
- Step 2: Return exhaust volume to original value.

 **NOTE:** Positive pressure ductwork conditions are strongly discouraged. Positive pressure ductwork conditions should be reviewed and evaluated by a cognizant Safety Officer of Industrial Hygienist as part of their Laboratory Ventilation Management Program and Chemical Hygiene Plan.

7.9 Cleanliness Classification Test for Pharmacy Application

If this cabinet is going to be used within pharmacy, per USP797¹, the cabinet must be tested to assure compliance to ISO 14644-1:2015 Cleanrooms and Associated Controlled Environments, Part 1: Classification of Air Cleanliness². The cleanliness classification test is performed using a particle counter to measure particle counts within the cabinet workzone. Turn on cabinet and let warm up for several minutes. Turn on particle counter and flush out sample tubing line to remove latent particles. Set the particle counter to measure 0.5 micron or larger particles at the appropriate measuring rate.

“Operational Particle Count Test”³

Position the particle counter isokinetic probe at a point 6 inches (152mm) upstream of the aseptic manipulation area (hand convergence point) and mounted so as not to interfere with the operator’s hand movement. The pharmacy operator will simulate IV manipulation during the particle count test using non-hazardous materials. A minimum of three (3) 1-minute particle counts shall be sampled and recorded while the user simulates aseptic compounding manipulations.

“At Rest Particle Count Test”

Take 5 test points in 1-minute intervals on a grid, in a horizontal plane as measured approximately 6 inches (152mm) above the worksurface. The grid location is designed as the workzone center point and each corner measured 6 inches (152mm) from the inside perimeter.

Record the 5 particle count values for each of the test points over the 1-minute sample time. All final count particle concentrations and calculated 95% upper confidence limit shall not exceed 3520 particles per cubic meter (ppcm) or (100 particles per cubic feet (ppcf)).

¹ USP28-NF23: United States Pharmacopeial Convention, Inc., 12601 Twinbrook Parkway, Rockville, MD 20852, USA, www.usp.org.

² ISO 14644-1:2015 Cleanrooms and Associated Controlled Environments-Classification of Air Cleanliness, International Organization for Standardization, Case Postale 56, CH-1211 Geneve 20, Switzerland

³ CAG-002-2006: CETA Compounding Isolator Testing Guide, Controlled Environment Testing Association, 1500 Sunday Drive, Suite 102, Raleigh, NC 27607, USA, www.cetainternational.org

7.10 Main Control Board Description & Replacement

To access the main control board for fuse or board replacement, remove screws at each upper side of the control center and allow the control center to rotate down, resting on the safety straps. Now the main control board is exposed for service.

7.10.1 Main Control Board Replacement

The main control board consists of two interconnected Printed Circuit Board (PCB) assemblies. The front PCB contains the LCD display. The back PCB contains the power supply, configuration switch, sensor inputs/outputs and control inputs/outputs components. The mechanical and electrical interconnects for the two PCB's all occur within the assemblies and are fastened together with standoffs and screws.

7.10.2 Main Control Board Fuse Replacement



Disconnect electrical power from cabinet before fuse replacement.

All AC circuits are fuse protected and when replacement is necessary, **USE ONLY FUSES OF SAME TYPE AND RATING FOR PROTECTION AGAINST RISK OF FIRE.**

DESCRIPTION:	BLOWER FUSE	OUTLET FUSE	ACCESSORY OUTPUT FUSE	LIGHT FUSE
FUSE TYPE:	TIME-LAG	TIME-LAG	TIME-LAG	TIME-LAG
FUSE SIZE:	1/4 X 1-1/4 INCH	5 X 20MM	5 X 20MM	5 X 20MM
NU-545-300E	6.25 AMPS	3 AMPS (2)	2 AMPS	1 AMP
NU-545-400E	8 AMPS	3 AMPS (2)	2 AMPS	1 AMP
NU-545-500E	10 AMPS	3 AMPS (2)	2 AMPS	1 AMP
NU-545-600E	10 AMPS	3 AMPS (2)	2 AMPS	1 AMP

7.10.3 Main Control Board Replacement

Note: All setup and calibration data will be lost, the memory reinitialized to the default values and all control functions reset to an initial cabinet power condition. If possible, before the main control board replacement, it would be preferred to know the operational parameters of the cabinet, (i.e. motor/blower voltage, setpoints, and airflow data from previous certification.

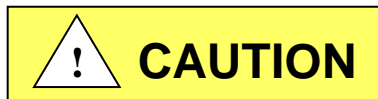

Disconnect electrical power from the cabinet before attempting any maintenance action.

The main control board is fastened to the control center with (6) 6-32 screws. All electrical connections are made with removable terminals and/or Fasten connectors except for the motor/blower connector which uses a screw terminal. Remove all electrical connections and fasteners then remove the main control board from the control center.

Install new main control board by reattaching all electrical connections and fasteners. Once installed, rotate control center to normal position and fasten in place.

Now reconnect power to cabinet. Upon BSCC system power up, a system master reset must be performed to clear the microprocessors non-volatile memory to assure proper system function.

7.10.4 Cabinet Reset

The main control board has two software operating resets available for qualified service personnel. The two types are the following:

Factory Reset: Resets setpoints and selected option settings. Factory reset should be used in the event the system memory develops an error in operation. Cabinet type, motor type, and calibration data will not be affected with this reset.

Master Reset: Resets all calibration, cabinet type, motor type sensor data, and options settings back to default settings. Master reset should only need to be used for a main control board replacement.

After pressing the Calibration/Service menu item, a password screen will appear. The default password is "9876". Once the service password is entered, the Calibration/Service menu will appear.



- Select CABINET RESET from the menu.

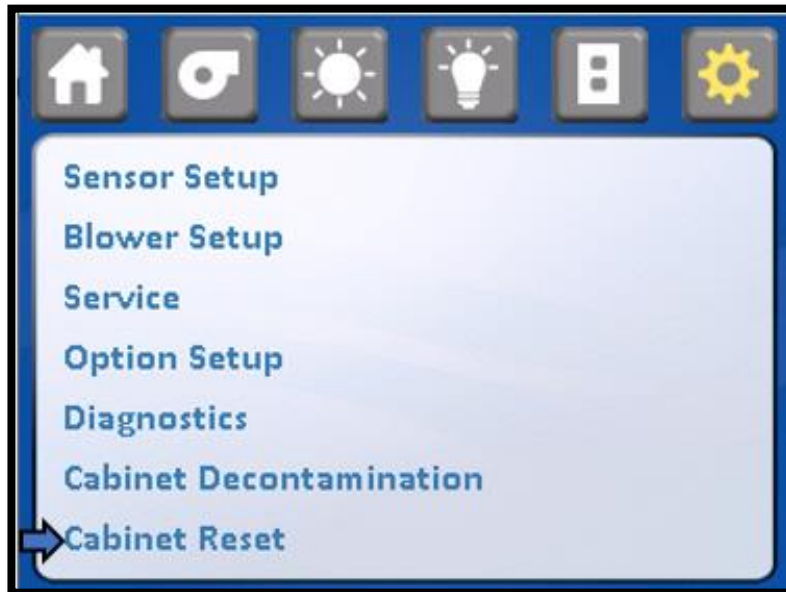

- Select desired function from menu.

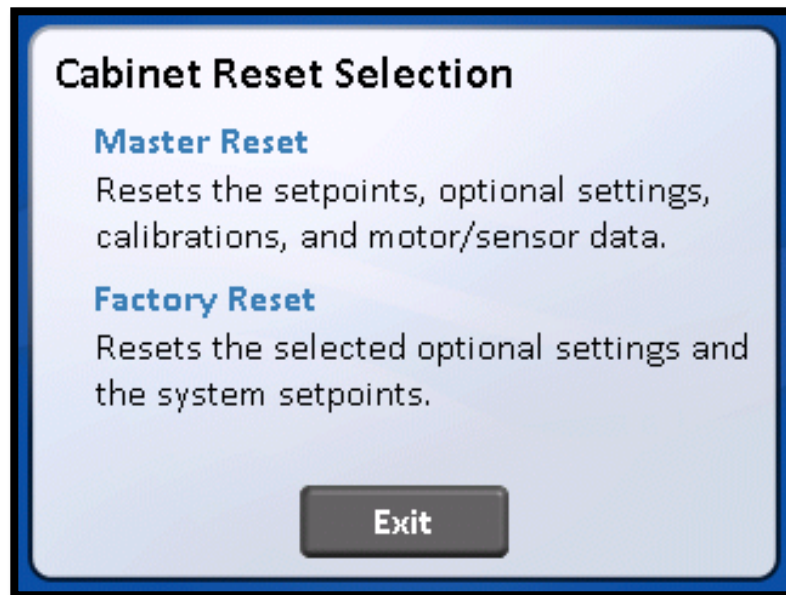

- Perform either reset function as selected below.



- Once factory reset is complete, return to Calibration/Service menu to enter any options.

- Once the MASTER RESET icon is pressed, the display screen will remain the same for approximately 1minute.



Also during this 1 minute, an audible signal of the reset process will occur. Once the reset process is complete the display screen will revert back to the Nuair logo main menu. At this point the cabinet MUST be turned off to complete the process. Either unplug the cabinet or use the power switch within the control center to turn off the cabinet. Turn the cabinet back on the display screen will remain blank for up to a minute, then will indicate "Power Loss Alert", press the screen to clear the message and return to the Calibration/Service menu to enter cabinet type and perform airflow calibration.

7.11 Digital Airflow Sensor Description & Replacement

The airflow sensor function utilizes two thermistors that provide a constant current source. One thermistor is a reference that uses a very low current source. The other thermistor is the airflow measurer that uses a very high current source. As airflow passes over the thermistors, the airflow removes heat from the thermistor measuring airflow. The loss of heat from the thermistor causes the voltage from the thermistor to increase. This increase subtracted from the reference thermistor output voltage is what directly relates to airflow velocity. A repeatable curve can be generated (voltage vs. airflow velocity).

The thermistors used are glass bead and coated and can be cleaned by gently using a cotton swab and alcohol. Formaldehyde gas, Hydrogen Peroxide and Chlorine Dioxide has no effect on the airflow sensors; however, the formaldehyde/Ammonium bicarbonate residue that remains after decontamination should be removed from the airflow sensor thermistors.



Disconnect electrical power from the cabinet before attempting any maintenance action.

The airflow sensors are removed by turning the locking ring counterclockwise and gently pulling the sensor away from the connector. To reattach the airflow sensor, turn sensor in keyed connector until key matches, push in and turn the locking ring clockwise until ring locks.

Once the new sensor(s) have been replaced, proceed to airflow calibration

8.0 Error Messages, Troubleshooting, Option-Diagnostics & Airflow Sensor Performance Verification

Audible alarms and error messages occur for a variety of reasons. Whenever an alarm condition has been present for a period of at least 10 seconds, the audible alarm/error message will be presented and stay on until the error is cleared. The audible alarm will be on for 10 seconds upon initial alarm condition, then once every 2 seconds. When presented with an error message, please perform the following:

Step 1: NOTE ALL ERROR MESSAGES.

Error message will appear just below the icons. Pressing the caution symbol will display the present active alarms.

Step 2: VERIFY ERROR MESSAGES.

Error messages can be verified by cleaning the error function by either turning the blower or the cabinet on and off.

Step 3: MONITOR RE-OCCURRENCE OF ERROR MESSAGES.

If re-occurrence of the error message is immediate or daily, use guide below to correct the situation.

8.1 Error Message Troubleshooting Guide

Error Message	Indicator	Correction
– Window Alarm (Window High)	Sliding window is above its standard working height or micro switch is not operating properly.	Verify standard working height and window micro switch operation.
– Window Alarm (Window Low)	Sliding window is below its standard working height or micro switch is not operating properly.	Verify standard working height and window micro switch operation.
– Airflow Alarm – Red Downflow Arrow (Downflow Low Limit)	Downflow airflow fell below its lower limit alarm setpoint.	Re-certify cabinet to proper airflow setpoints.
– Airflow Alarm – Red Downflow Arrow (Downflow High Limit)	Downflow airflow went above its high alarm setpoint.	Re-certify cabinet to proper airflow setpoints.
– Airflow Alarm – Red Inflow Arrow (Inflow Low Limit)	Inflow airflow fell below its lower limit alarm setpoint.	Check orientation of exhaust sensor shroud. Re-certify cabinet to proper airflow setpoints.
– Airflow Alarm – Red Inflow Arrow (Inflow High Limit)	Inflow Airflow went above its high alarm setpoint.	Check orientation of exhaust sensor shroud. Re-certify cabinet to proper airflow setpoints.
– Low Pressure Alarm (Low pressure Limit)	Indicates low pressure or low cabinet airflow	Re-certify cabinet to proper airflow setpoints.
Cabinet LED lights won't turn on.		Check light fuse on main control board. Check LED lamps. Check voltage coming out of main control bd. to light ballast's. Check light starters, if present. Check ballast.
Cabinet blower won't turn on.		Check blower fuse on main control board. Check AC voltage coming out of main control bd. Check wiring to blower. Check blower motor. Check DC motor PWM signal on main control bd.
Display indicates (Remote Override Active)	Indicates that the remote override is activated, preventing the usage of the cabinet	
Power Loss Alert!	Indicates a power interruption has occurred.	Press display to clear message.
Cabinet outlets won't turn on.		Check outlet fuse located on main control board. Check voltage coming out of main control board.
Cabinet ultraviolet light won't turn on.		Check sliding window position so that it's fully closed. Check blower/lights fuse on main control board. Check voltage coming out of the main control bd. to ultraviolet light ballast. Check light starters, if present. Check ballast.
Blower or light fuse continues to blow after replacement.		Check for short on output of fuse. Isolate output of fuse by disconnecting control center connectors, light circuit, AC or DC blower circuit, etc. to isolate short.
Replace UV Light!	Indicates that the UV light needs replacement	Replace UV light and clear UV run time clock.
Display indicates (Night Setback Active)	Indicates that the night setback is activated, preventing the usage of the cabinet.	
Power window option is malfunctioning.	Window does not open and close correctly.	Try to fully open the window to initiate the self-calibration feature. Activate the auto-reverse function by placing a soft object, i.e. rubber stopper under window and lower until window auto reverses and is raised to its self-calibrating point. Re-calibrate power window memory points.
Active Alarms DN Sensor Comm! EX Sensor Comm!	Indicates a digital communications error from the main control board to the airflow sensors.	Check connectors and wires from main control board to the airflow sensors. DN indicated downflow sensor. EX indicates exhaust sensor.
Active Alarms DN Sensor Error! EX Sensor Error!	Indicates an error signal generated by the sensor.	Check airflow probe connector on main board. (Ref. Section 7.11). Replace airflow sensor if required.

Error Message	Indicator	Correction
Touch Link Display User Interface	Touch area's of display do not Align w/ icons	Calibrate display in adjust display brightness screen
Run Time Failure	Indicates a temporary microprocessor issue	Clean alarm a see it reoccurs, check line voltage to control board, replace control board
Recertification Due/ Past Due		Reset certification date in calibration /service menu
Blank Display Audible / Visual Alarms Active	Microprocessor Failure	Cycle cabinet power OFF/ON Replace control board

8.2 Calibration/Service Menu

8.2.1 General

As with the airflow calibration process, the service menu should only be accessed by a Service Technician that is familiar with the product.

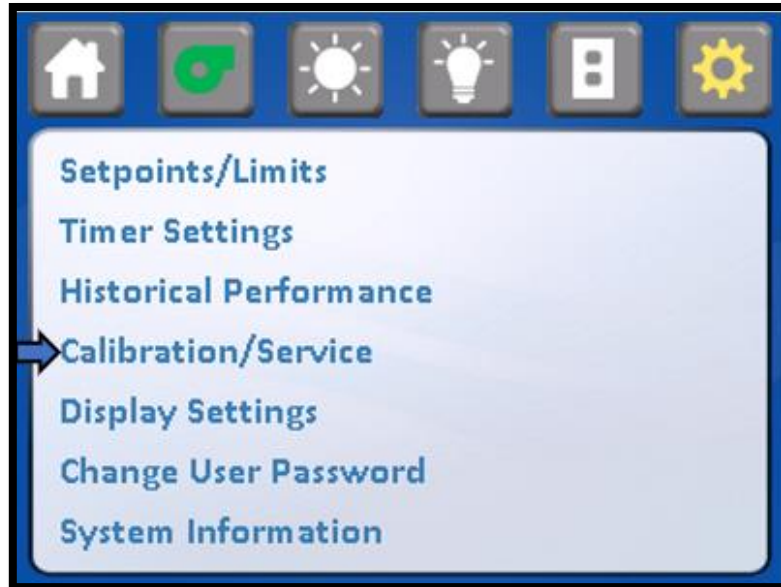

Entry into the Calibration/Service functions requires a service password for entry. After pressing the Calibration/Service menu item, a password screen will appear. The default password is "9876". Once the service password is entered, the Calibration/Service menu will appear. To exit, either press the menu or home icon.

One additional feature for service technicians is to bypass the whole 2 minute warmup time. By pressing the word warmup, the system will move directly to run. It is recommended that at least a minute of warmup time be observed, so the airflows can stabilize at their setpoints to avoid an alarm condition.



8.2.2 Calibration/Service Menu

- The Calibration/Service menu provides a list of sub-menu items to accomplish all service tasks. Each sub-menu item will be described in the following sections
- **Blower Setup:**
 - The blower setup menu item provides an access to blower options and night setback setup Menu Blower options



- **Blower Options**

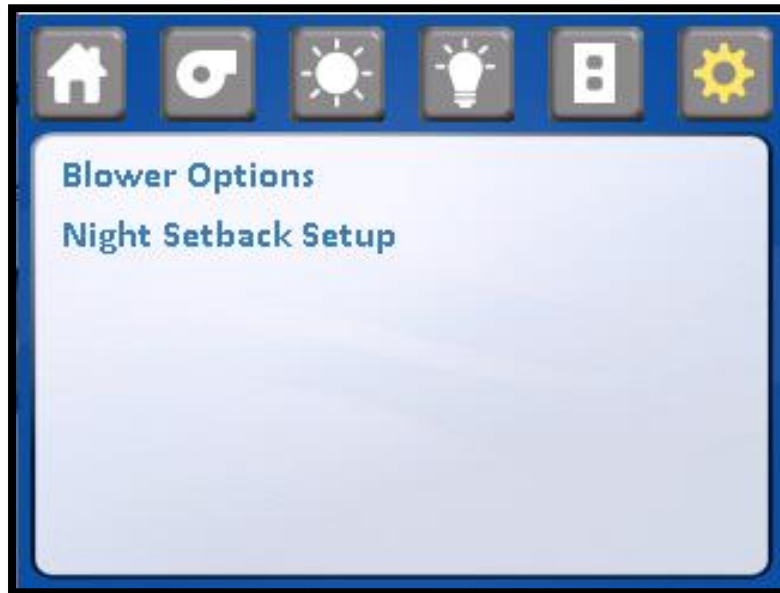

- **Manual Blower Control**

This parameter allows **ONLY THE CABINET TECHNICIAN** to run the cabinet in manual mode. This means with no controls or alarms activated. When the manual control is on, the downflow and inflow displays will indicate nominal setpoints. Airflow adjustments can be made in the manual mode by going into airflow calibration and adjusting the blower duty cycle. The blower duty cycle will remain constant in manual mode. The display will also indicate the manual control is activated. When the manual control is off, full automatic control resumes.

- **Blower Lockout**

This parameter allows the access to turn the blower on or off to be restricted by the use of a password. When the blower lockout is on, pressing the blower icon will produce a numerical password screen.

- **Password Reset**

The default password is “1234” and may be changed using the password reset. When the blower lockout is off, the blower may be turned on and off without restriction.



- **Night Setback setup:**

The night setback setup menu item provides an access to night setback option and night setback Calibration.

- **Night setback option**

The night setback option is enables night setback by turning to ON. When night setback option turned ON, the night setback icon displays on home screen.



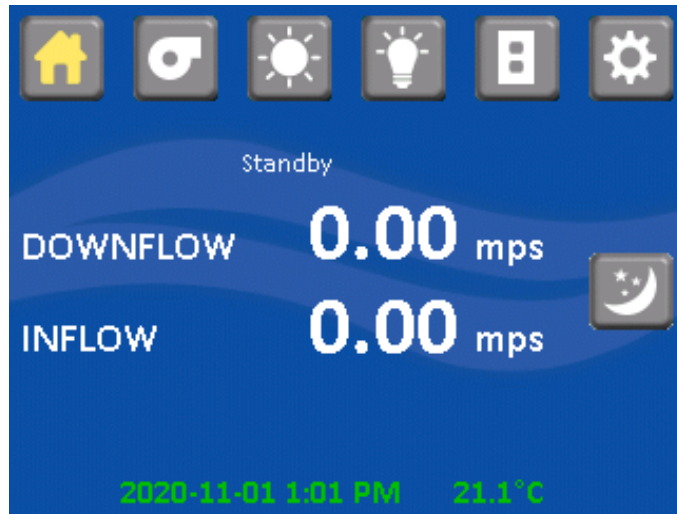

- **Night setback calibration**

The night setback calibration is calibrated as a percentage of the nominal setpoint and should be adjusted during the certification process to the desired level. The default for night set back downflow velocity is 0 fpm (0.15 mps).

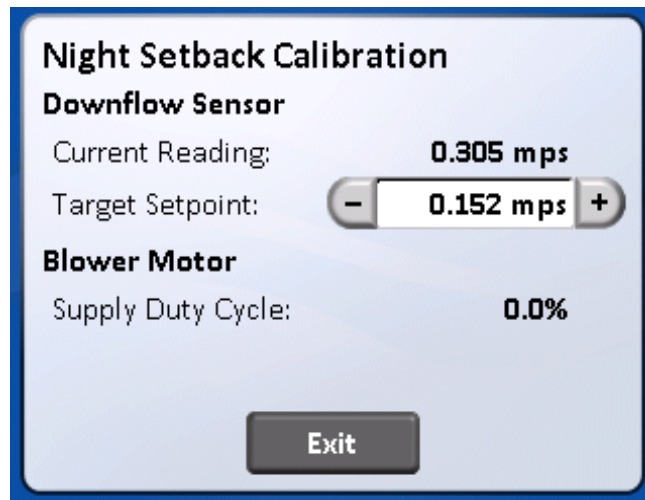

- **Service**

The service setup menu allows a QUALIFIED TECHNICIAN to configure, calibrate and obtain functional service data. Each parameter submenu will be described as well as the display will indicate present and/or default conditions as shown.

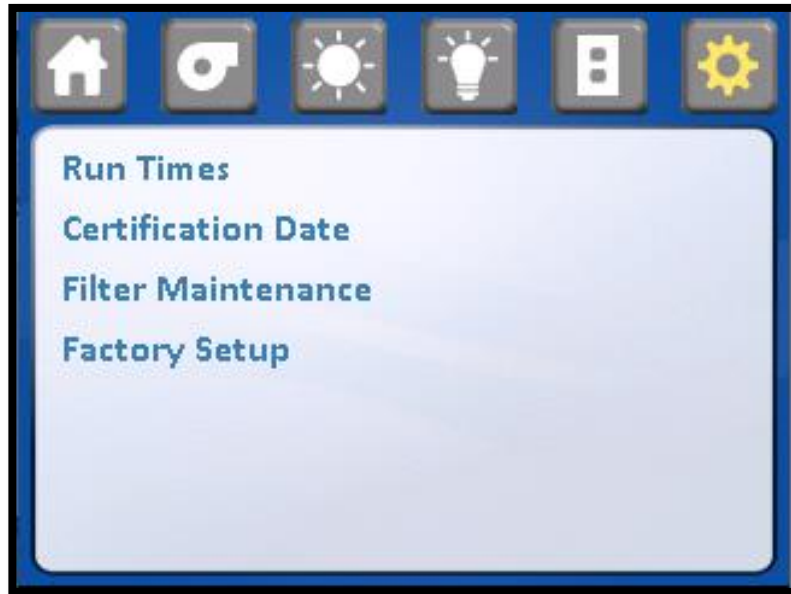

- **Run Times**



- **UV Light Run Time:**
UV light run time value. Reset if replacing the UV lamp.



- **Blower Motor Run Time**
Blower Motor Run time or enter old value if replacing control board

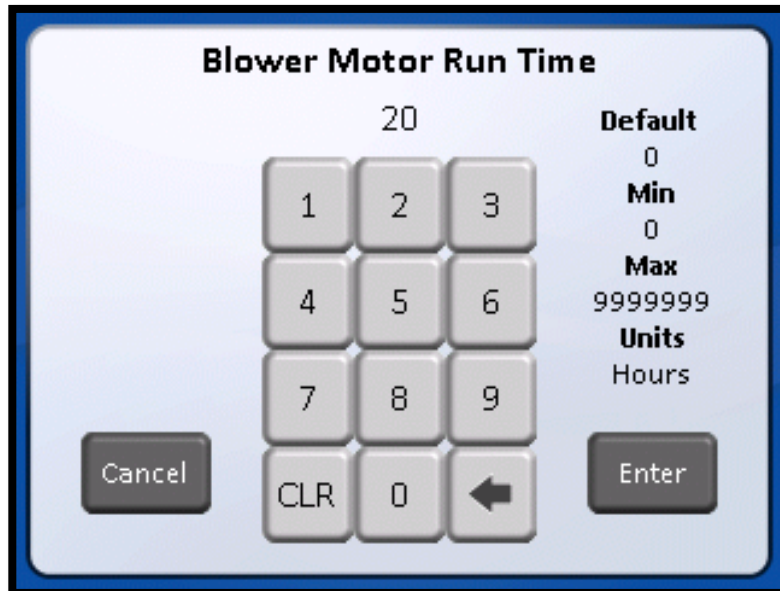

- **Certification Date**

This parameter allows the service technician to view and update the current certification date, in addition to notification time period.

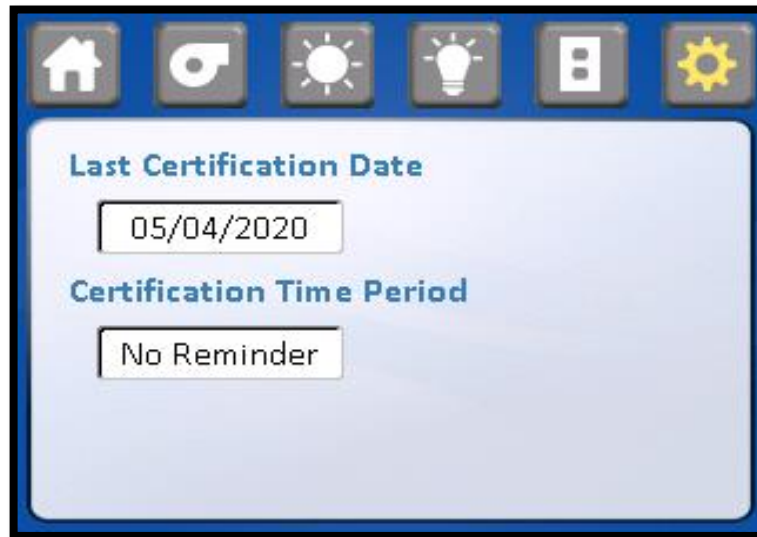

- **Filter Maintenance:** This parameter allows the service technician to set the filter status data used to predict filter life availability. Filter status is based on maximum RPM minus the starting RPM (entered by technician) then scaled to current RPM to determine filter percentage availability. Starting RPM data may be entered at any time for service purposes.

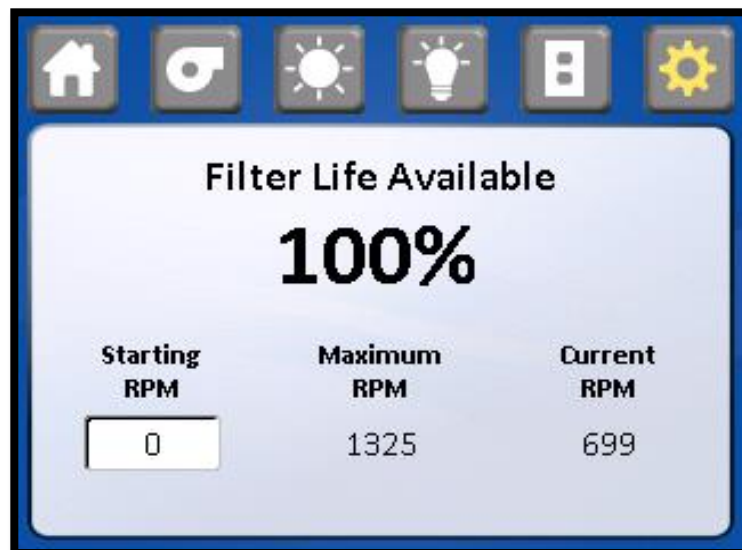

- **Factory Setup**

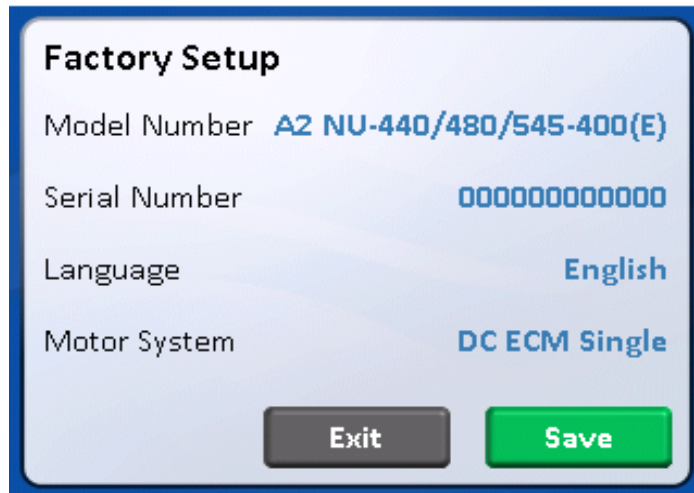

- **Option Setup**

The option set up menu allows **A QUALIFIED TECHNICIAN** to configure several different optional parameters per the menu below. Each parameter sub-menu will be described as well as the display will the default conditions as shown

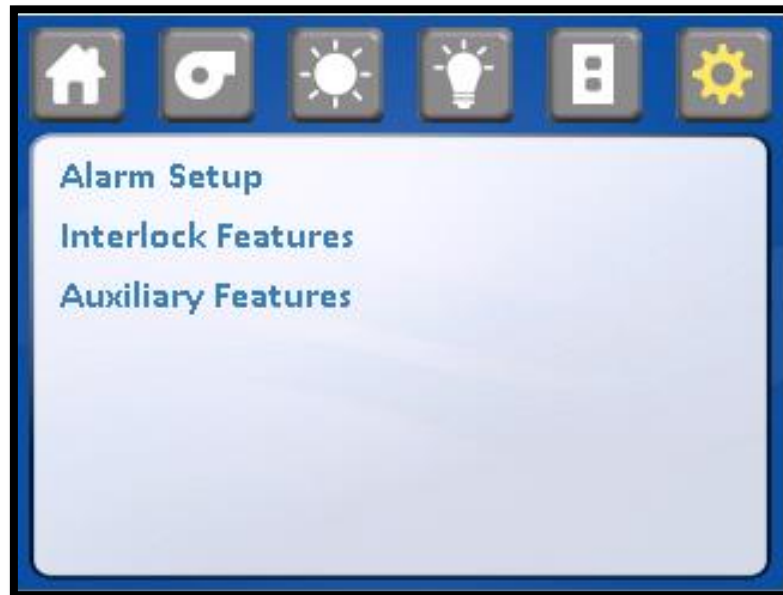

- **Alarm Set Up**

- **Alarm Silence**

This parameter allows for the selection of the alarm silence key function. When the alarm silence function is on, all current and future alarms will be silenced for the designated alarm silence time (i.e. default time is 15 minutes). When the alarm silence function is off, airflow alarms cannot be silenced. The alarm silence key will only appear for window high alarms typically used for cleaning activities.

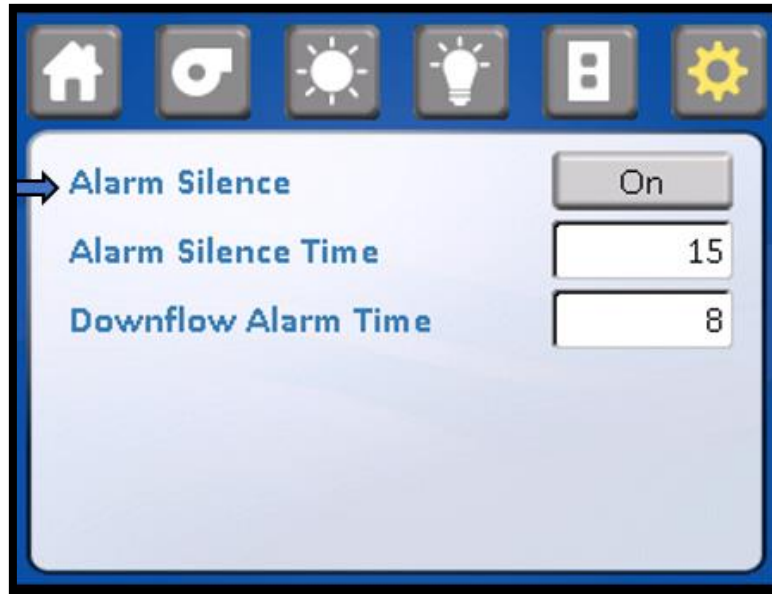

- **Alarm Silence time**

This parameter allows for the selection of time to determine how long the audible alarm shall be silenced. The time is displayed in minutes with a programmable range of 1 to 60



- **Downflow Alarm Time**

This parameter allows for the selection of time to determine how many continuous seconds of an



alarm condition occurs before activating an audible and visual alarm. The time is displayed in seconds with a programmable range from 2 to 12 seconds.

- **Interlock Features**

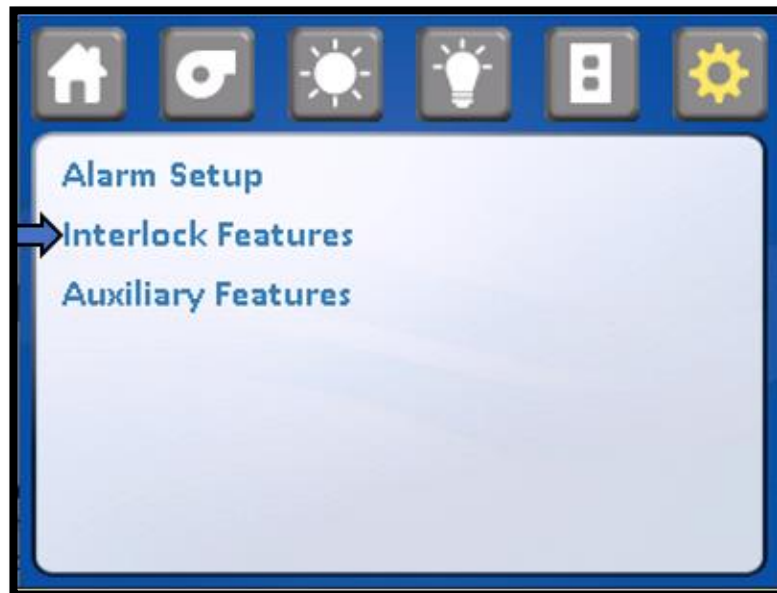

All interlocks are enable/ disabled by a user through the interlock Features screen

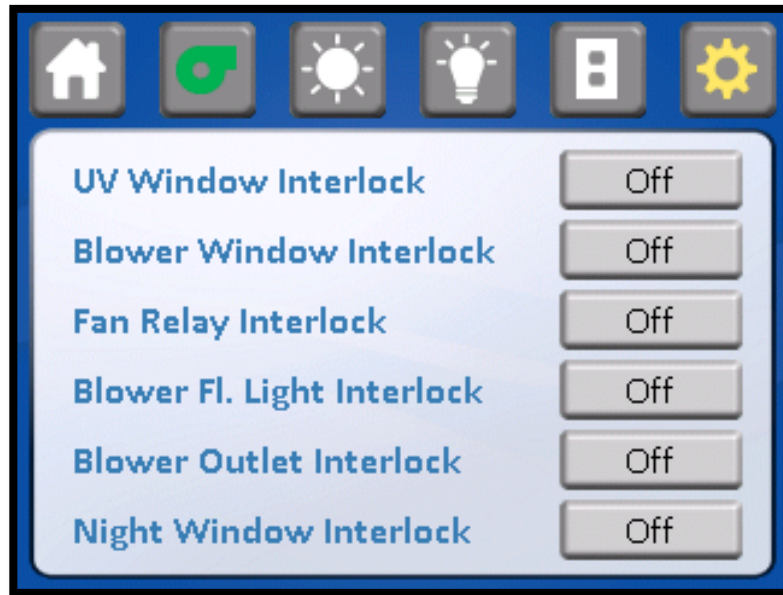

o **UV window interlock:**

This parameter allows for the selection of the window closed switch to be interlocked with the UV light option. When the window interlock is on, the window must be closed for the UV light to operate. When the window interlock is off the UV light can be turned on regardless of the window position.



NOTE: In addition to the **TOUCHLINK** system UV window interlock there is a double redundant UV window interlock relay. To override the UV window interlock for service purposes only, both interlocks must be changed through the **TOUCHLINK** system and shorting the relay connection. (See electrical schematic for reference)



○ **Blower Window Interlock**

This parameter allows for the selection of the window closed switch to be interlocked to the blower. When the blower interlock is on, the blower will turn off when the window is closed. When the blower is off, the blower will continue to run when the window is closed.

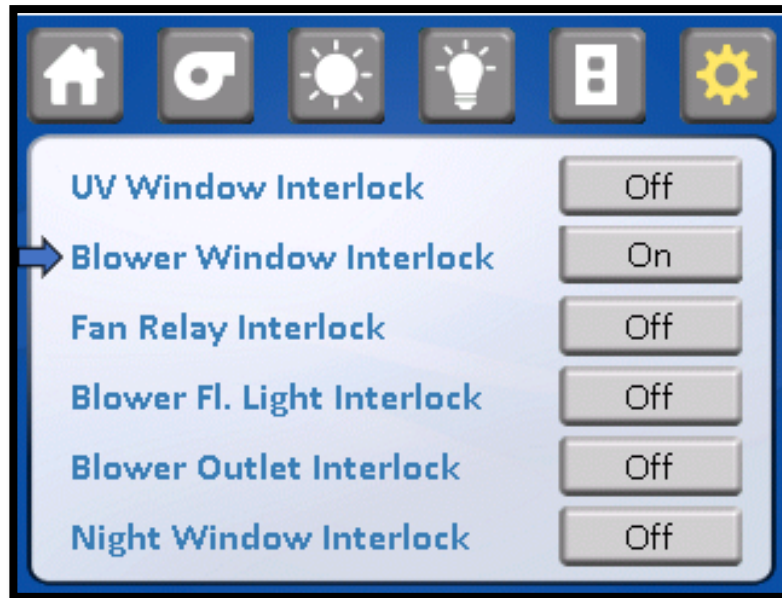

○ **Fan Relay Interlock**

This parameter allows for the selection of the fan relay interlock operation. When the fans relay interlock is on, and the blower switch is pending or blue, the fan relay will be off or not energized. If the fan relay interlock is off and the blower switch is pending or blue, the fan relay will be on or energized. In either case the fan relay will be on when the blower switch is on or green and off when the blower switch is off or not colored.

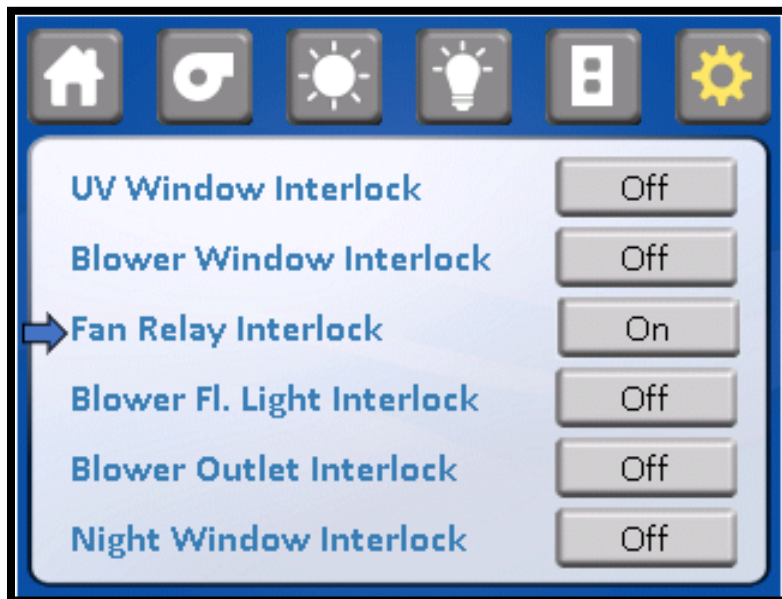

○ **Blower LED Light Interlock**

This parameter allows for the selection of the LED light option to be interlocked to the blower. When the blower FL light interlock is on, the LED light operation will be interlocked to the blower. When the blower FL light interlock is off, the LED light can be turned on at any time

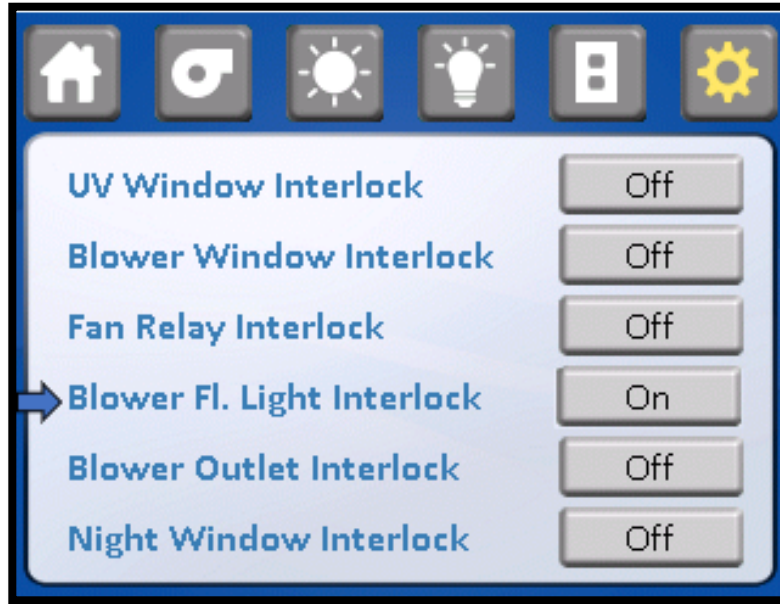

○ **Blower Outlet Interlock**

The blower/outlet interlock turns on/off the outlets whenever the blower is turned on/off. The outlet power can no longer be controlled manually.



- **Night Setback Window Interlock**

This parameter allows for the selection of the night setback function to be initiated upon a sliding window closure. Once the sliding window is closed, the LED light will be disabled, and the airflow will be reduced to a percentage of the normal setpoint.



NOTE: Blower window interlock must be turned off to allow the night setback function to operate.

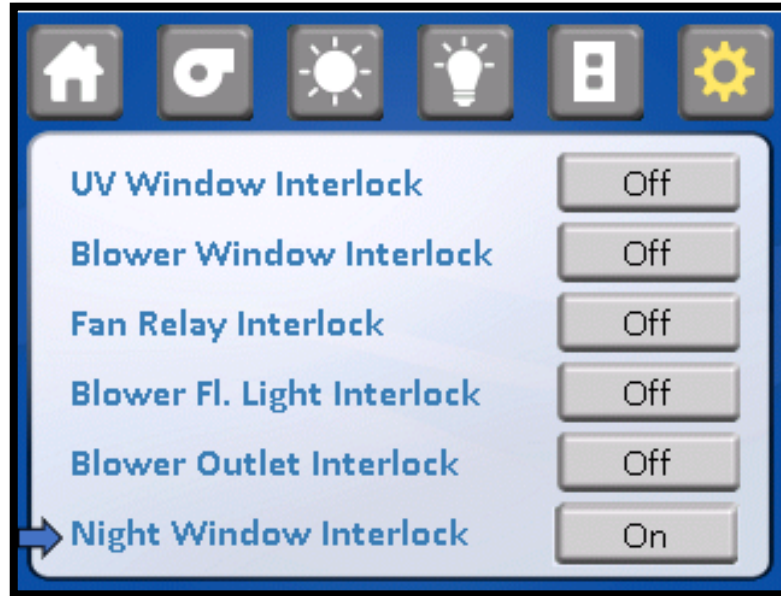

- **Auxiliary Features:**

This parameter allows the access to turn on or off the auxiliary relay function, accessory outlet and power window.

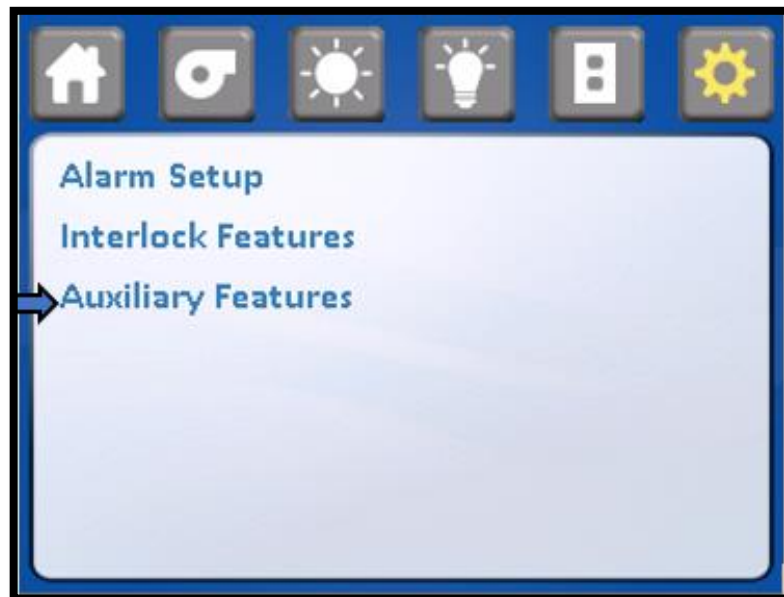

- **Auxiliary relay function**

This parameter allows for the selection of the AUX relay function. When the AUX relay is on, the AUX relay function will be identical to the fan relay. When the AUX relay function is off, the AUX relay function provides delay On/Off option.



- **Accessory Outlet**

This parameter allows for the selection of the power connection that supplies power to the exhaust decon chamber to be interlocked to the blower. This parameter would only be used in special cases and does not affect operation during an auto decon cycle.

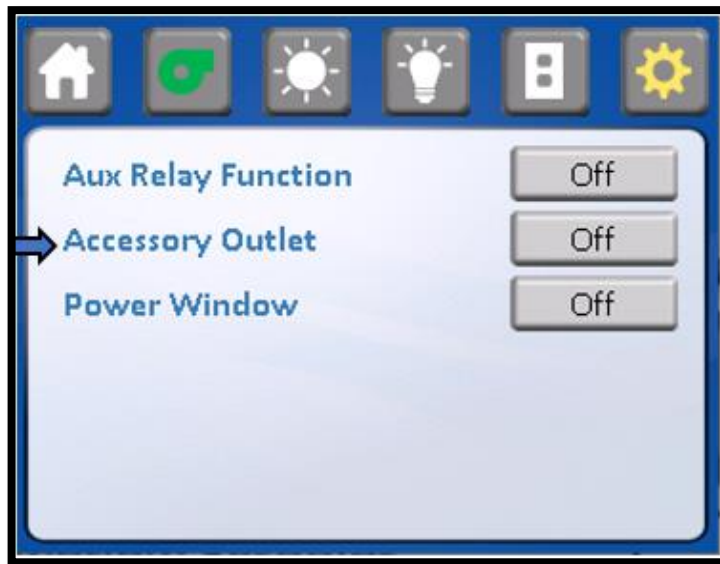

- **Power Window**

This parameter allows for the power window option to operate. When the power window option is factory installed this parameter will allow the user display menu to indicate the power window up and down icons

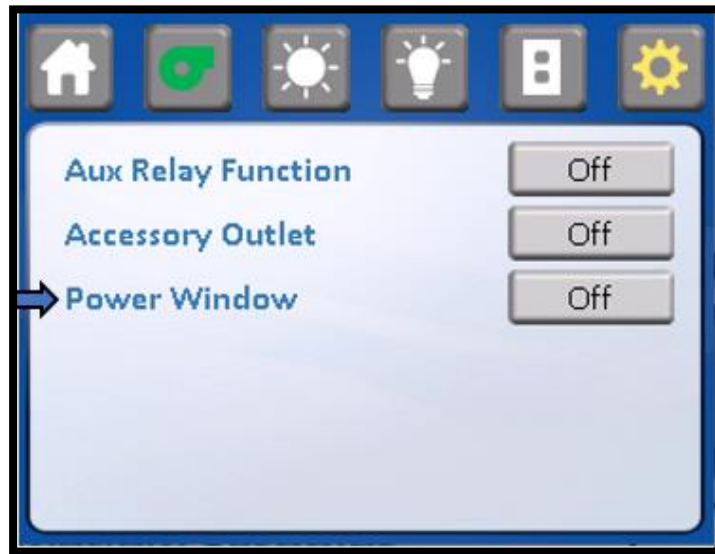

The power window option functions using a 24 Vdc motor and internal feedback encoder to determine window position. The power window also incorporates a safety auto reverse feature to eliminate any pinch hazard.

Select power window option on a window icon up and down will show on main screen, when the power window off the window icon disappeared

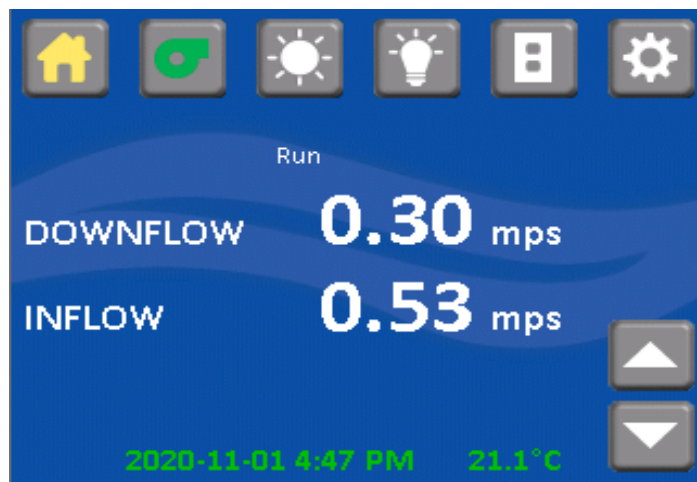



- **Diagnostics**

The General input and output diagnostics menu allows **A QUALIFIED TECHNICIAN** to exercise the control system's inputs and outputs

- **Blower/Sensor Diagnostic**

Blower/sensor diagnostics reports the current blower and sensor function information.

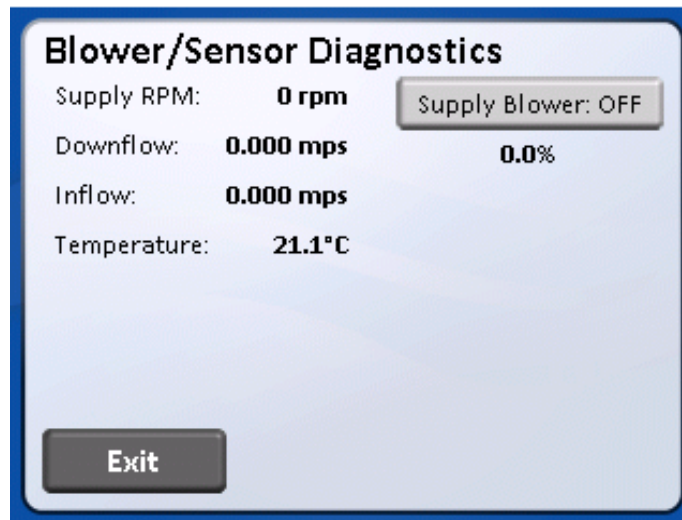

- **Window Diagnostics**

Read inputs all service technician to exercise or check these input function. The inputs may be checked by altering the input function (i.e. sliding window position) and monitoring the change on the display

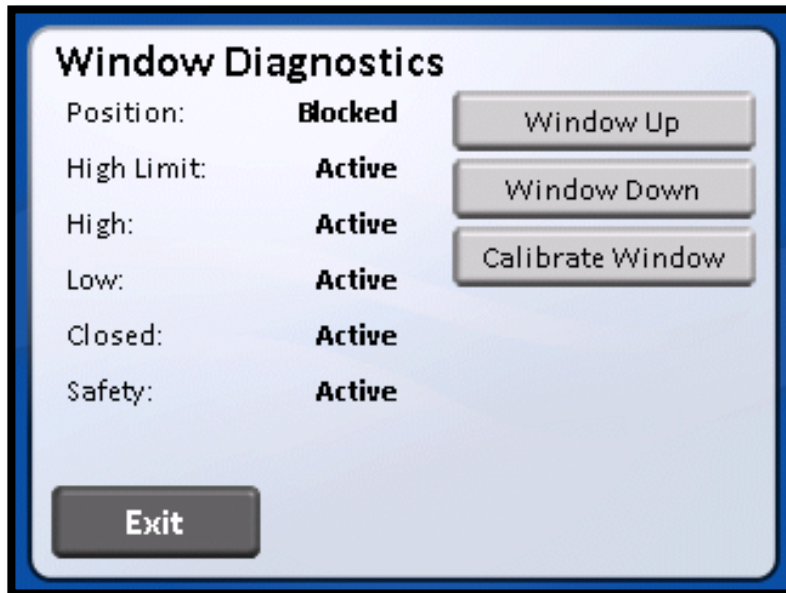

- **Power Window Calibration**

The power window can be calibrated by the micro switch position within the right window glide assembly for major adjustments. For minor adjustments, the window can be stepped up or down to check for activation points or move into desired access opening height (default window height is 10 inches (254mm)). Then the Auto Cal can be used to lock in the window position based on the activation points of the window high and low microswitches. The Auto Cal will run a sequence, first lowering the window to the window low position, the raise the window to window high position and back down to the work access opening height. Smaller changes can be made by adjusting the counts. Low calibration

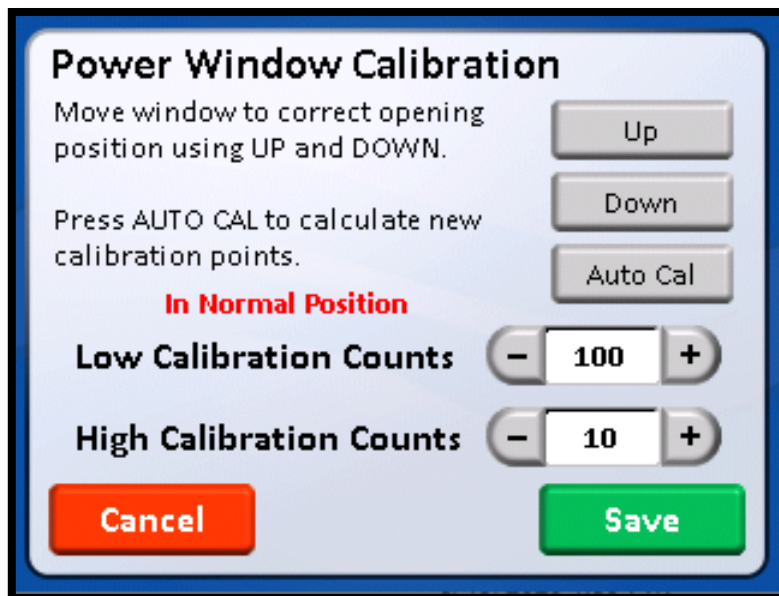

counts would be when the window is being raised from the low window microswitch and high calibration counts would be when the window is being lowered from the high window microswitch. Press save to enter calibration changes.

Micro Switch Position	Micro Switch Function	Window Function (approximate values)
Top	Max Window Height	Stops when activated
Top Middle	Window High Alarm	Continues to travel down for 1/8" (3mm) past switch deactivation
Bottom Middle	Window Low Alarm	Continues to travel up for 1-7/8" (48mm) past switch deactivation (Used only with power window option)
Bottom	Window Closed	Stops when deactivates

▪ **General I/O Diagnostics**

Test outputs allow a service technician to exercise these output functions. Pressing TOGGLE will turn on and off the functions. Press button to select the test output to select the test output desired.

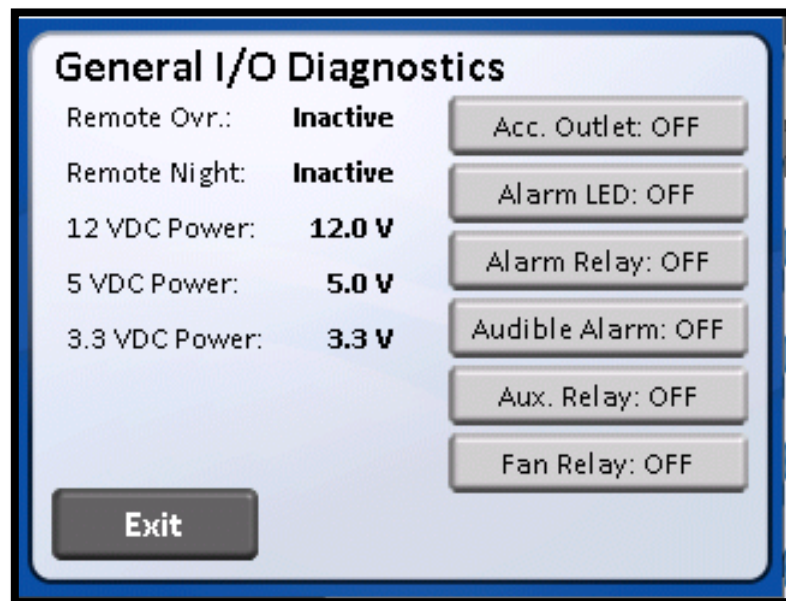

8.3 Airflow Sensor Performance Verification

The individual airflow sensors can be routinely checked during calibration or in diagnostics to assure they are reading and active within the range of use (0 to 200 fpm). The airflow sensors can also be checked in the run mode through performance verification, for responsiveness to changing airflow conditions.

8.3.1 Run Mode

To check the airflow sensor in run mode, first allow the cabinet to operate normally for a minimum of 5 minutes. Then, place a rolled piece of paper over the downflow sensor in the workzone and leave the paper on the sensor for at least 2 minutes and then remove. This action will cause the cabinet to go into a downflow alarm condition. The exhaust airflow reading should increase during this test. However, the downflow reading should go down to zero on the display "0". There should also be a noticeable increase in motor/blower noise. It would also be recommended to monitor motor/blower voltage during the test. The motor/blower voltage should be monitored from when the cabinet is running normally. During the test, when the downflow sensor is covered, the

motor/blower voltage should be steadily increasing too slightly under line voltage. When the downflow sensor is uncovered, the motor/blower voltage should decrease and airflow readings should be within the calibration range.

If the motor/blower voltage does not change, an airflow sensor problem could exist. Please consult with Nuair Technical Service.

9.0 Remote Contacts

The NU-545E has several contact closures for remote sensing of various functions.

9.1 Fan Relay

The fan relay contacts are dual normally open contact closure outputs which are activated whenever the blower is turned on. Contact ratings are 250 VAC maximum at 2 Amps.

9.2 Alarm Relay

The alarm relay contacts are dual normally open contact closure outputs which are activated whenever an airflow alarm condition occurs. An airflow alarm condition will occur if either airflow sensor detects 5 consecutive 2 second airflow readings above or below the alarm limits. Contact ratings are 250 VAC maximum at 2 Amps.

9.3 AUX Relay

The AUX relay contacts are common, normally open and normally closed contact closure outputs which are activated whenever the blower is turned on. However, the AUX relay does have some conditional logic programmed. The relay will activate whenever the blower is turned on and stay on unless after 5 minutes there is a low exhaust alarm, then the relay will deactivate. If exhaust is sufficient, the relay will stay active. If the blower is then turned off, the relay will stay active for one minute then deactivate. The AUX relay may also be selected to operate the same as the fan relay. Reference the AUX relay function in the option menu. Contact ratings are 250 VAC maximum at 2 Amps.

9.4 Remote Override

The remote override contacts (P-26 RMO) are (no power) **shorting contacts only**, which when closed, indicates to the control system to shut down the cabinet. The blower would be turned off, an audible alarm would be turned on for several seconds and the clock display will indicate "RM.OV".

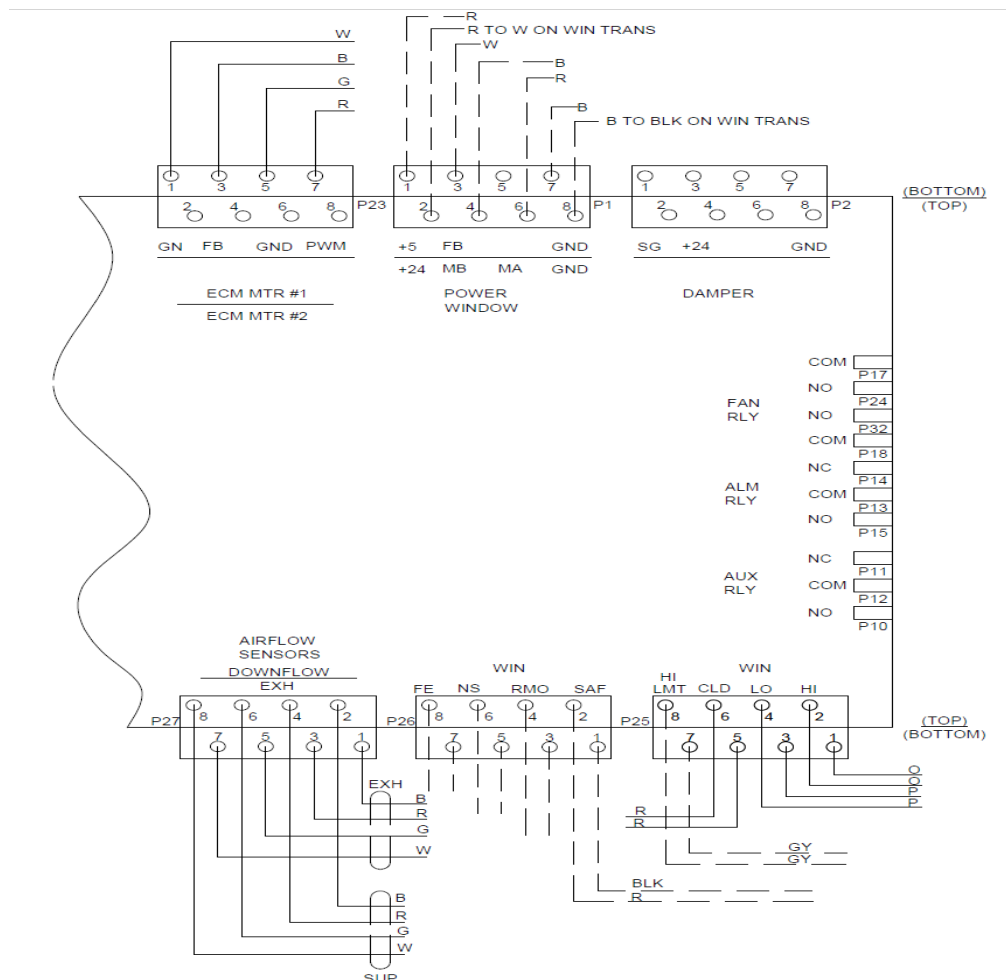

10.0 Optional Equipment

10.1 Ultraviolet Light



Ultraviolet light will injure your eyes. Avoid direct viewing at all times. Personnel should not be present when ultraviolet lamp is on

10.1.1 Overview

The germicidal ultraviolet is primarily intended for the destruction of bacteria and other microorganisms in the air or on directly exposed surfaces. Approximately 95% of the ultraviolet radiations from germicidal tubes are in the 253.7 nanometer region. This is a region in the ultraviolet spectrum which is near the peak of germicidal effectiveness. The exposure necessary to kill bacteria is the product of time and intensity. High intensities for a short period of time, or low intensities for a longer period are fundamentally equal in lethal dosage on bacteria (disregarding the life cycle of bacteria). The intensity of light falling on a given area is governed by the inverse law; that is the killing intensity decreases as the distance increases from the tube.

The germicidal tube is placed in the cabinet to provide an average intensity of 100 microwatts per centimeter (for a new tube) falling on a horizontal plane defined by the bottom of the work surface. The minimum requirement per paragraph 5.12 of NSF Standard 49 is 40 microwatts per square centimeter (ref. NSF Std. #49, June, 1976).

Since ultraviolet rays will not penetrate ordinary glass, it is recommended that the sliding window be closed while the ultraviolet light is on within the cabinet; or that personnel leave the cabinet face area.

10.1.2 Operation

The operation of the ultraviolet light is accomplished by closing the sliding window and pressing the UV switch located on the front panel. The sliding window is interlocked to the ultraviolet light so, when the sliding window is raised, the ultraviolet light will turn off. If operational time duration is known, the timer can be used in conjunction with the ultraviolet light to time out the ultraviolet light operation. This can be accomplished by first turning on the ultraviolet light. Then, set the timer to the desired length of ultraviolet light operation time. Upon timer expiration, the ultraviolet light will turn off.

10.1.3 Precaution

The rays from germicidal tubes may cause a painful but temporary irritation of the eyes and reddening of the skin, if of sufficiently high intensity, or if exposure covers a prolonged period of time. For this reason, one should avoid direct eye and skin exposure to ultraviolet light. If exposure cannot be avoided, it is necessary for personnel to wear eye goggles or face shields, and long sleeve gowns with rubber gloves.

Since ultraviolet rays will not penetrate ordinary glass, it is recommended that the sliding window be closed while the ultraviolet light is on within the cabinet; or that personnel leave the cabinet face area.

10.1.4 Maintenance

The output of an ultraviolet light deteriorates with burning age. The useful life of the light is approximately 7000 hours under specific test conditions.



NOTE: Before testing with lamp off, the light may be cleaned with a lint-free cloth dampened with alcohol or ammonia and water.

It is recommended that either a time schedule be established or the tube's output be measured periodically and the tube replaced when its output falls below 40 microwatts per square centimeter or exceeds 7000 hours of operation. Lights should be allowed to operate approximately 5 to 10 minutes (longer when the light is in low temperatures) to warm up sufficiently before reading the output with a meter.

Energies Required to Destroy Some Microorganisms by Ultraviolet Radiation's (e)

Mold Spores	Microwatt seconds per cm/2	Protozoa	Microwatt seconds per cm/2
Penicillium roqueforti	26,400	Paramecium	200,000(a)
Penicillium expansum	22,000		
Penicillium digitatum	88,000	Nematode Eggs	40,000(b)
Aspergillus glaucus	88,000		
Aspergillus flavus	99,000	Algae	22,000(c)
Aspergillus niger	330,000		
Rhizopus nigricans	220,000	Virus	
Mucor racemosus A	35,200	Bacteriophage (E. Coli)	6,600
Mucor racemosus B	35,200	Tobacco Masaic	440,000
Oospora lactis	11,000	Influenze	3,400(d)
Yeasts			
Saccharomyces	13,200		
ellipsoideus	17,600		
Saccharomyces cerevisiae	13,200		
Brewers' yeast	6,600		
Baker's yeast	8,800		
Common yeast cake	13,200		
Bacteria			
Streptococcus lactis	8,800		
Strep. hemolyticus (alpha type)	5,500		
Staphylococcus aureus	6,600		
Staphylococcus albus	5,720		
Micrococcus sphaeroides	15,400		
Sarcina lutea	26,400		
Pseudomonas fluorescens	7,040		
Escherichia coli	7,040		
Proteus vulgaris	7,480		
Serratia marcescens	6,160		
Bacillus subtilis	11,000		
Bacillus subtilis spores	22,000		
Spirillum rubrum	6,160		

References:

- (a) Luckiesh, Matthew (1946) Application of Germicidal, Ethyemal and Infrared Energy, D. Van Nostrand o., New York, New York, pp 253
- (b) Hollaender (1942) Aerobiology, A.A.A.S. (for 90% inactivation), pp 162
- (c) Ellis, C. and Wells, O.O. (1941) The Chemical Action of Ultraviolet Rays, Reinhold Publishing Corp., pp. 713-714
- (d) Hollaender, A., Oliphant, J.W. (1944) The inactivation effect of monochromatic ultraviolet. Radiation on Influenze Virus (for 90% inactivation) Jour. of Bact. 48, pp. 447-454
- (e) This table, "Energies Required to Destroy Some Microorganisms by Ultraviolet Radiation's" comes from Westinghouse brochure entitled - "Westinghouse Sterilamp Germicidal Ultraviolet Tubes"

11.0 Electrical/Environmental Requirements

11.1 Electrical (Supply Voltage Fluctuations Not to Exceed +/- 10%)

*NU-545-300E	230 VAC,	50/60 Hz,	1 Phase,	8 Amps
*NU-545-400E	230 VAC,	50/60 Hz,	1 Phase,	10 Amps
*NU-545-500E	230 VAC,	50/60 Hz,	1 Phase,	11 Amps
*NU-545-600E	230 VAC,	50/60 Hz,	1 Phase,	11 Amps

*CE Certified

11.2 Operational Performance (for indoor use only)

Environment Temperature Range:	60°F-85°F (15°C - 30°C)
Environment Humidity:	Maximum relative humidity 80% for temperatures up to 31°C decreasing linearly to 50% relative humidity at 40°C
Environment Altitude:	6562 Feet (2000 meters) maximum

11.3 Light Exposure

Standard LED Lighting @ 150 ft. candles (1614 LUX) maximum intensity.

11.4 Installation Category: 2.0

Installation category (overvoltage category) defines the level of transient overvoltage which the instrument is designed to withstand safely. It depends on the nature of the electricity supply and its overvoltage protection means. For example, in CAT II, which is the category used for instruments in installations supplied from a supply comparable to public mains such as hospital and research laboratories and most industrial laboratories, the expected transient overvoltage is 2500 V for a 230 V supply and 1500 V for a 120 V supply.

11.5 Pollution Degree: 2.0

Pollution degree describes the amount of conductive pollution present in the operating environment. Pollution degree 2 assumes that normally only non-conductive pollution such as dust occurs with the exception of occasional conductivity caused by condensation.

11.6 Chemical Exposure

Chemical exposure should be limited to antibacterial surface disinfectants used for cleaning and disinfecting. **USE OF CHLORINATED OR HALOGEN MATERIALS IN THE CABINET MAY DAMAGE STAINLESS STEEL.**

Equipment decontamination can be accomplished by non-condensing gas or vapor Paraformaldehyde, Hydrogen Peroxide or Chlorine Oxide following NSF/ANSI 49, Annex I-2 (formerly Annex G).

11.7 EMC Performance (classified for light industrial)

Emissions:	EN61326
Immunity:	EN61326



Class A equipment is intended for use in an industrial environment. In the documentation for the user, a statement shall be included drawing attention to the fact that there may be potential difficulties in ensuring electromagnetic compatibility in other environments, due to conducted as well as radiated disturbances.

12.0 Disposal and Recycle

Cabinets that are no longer in use and are ready for disposal contain reusable materials. ALL components with the exception of the HEPA filters may be disposed and/or recycled after they are known to be properly disinfected.

 **Note:** Follow all local, state and federal guidelines for disposal of HEPA filter solid waste.



BIOHAZARD

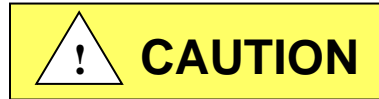

Prior to any disassembly for disposal, the cabinet must be decontaminated.



RECYCLE



LEAD FREE

Component

Base Cabinet
Front Grill
Worksurface
Window Faring
Window Glides
Window
Window Frame
Front Service Panel
Front Decorative Panel
Control Center
Supply Diffuser
Exhaust Filter
HEPA Filter Frames
Hepex Bag
Blower Wheel & Housing
Motor
Printed Wiring Assembly
Wire
Ballasts
Armrest
Connectors
Hardware

Material

Stainless Steel
Stainless Steel
Stainless Steel
Stainless Steel
HDPE
Safety Glass
Stainless Steel
Painted Steel
Painted Steel
Painted Steel
Aluminum
Aluminum
Painted Steel
PVC
Steel
Various Steel
Lead Free Electronic
PVC Coated Copper
Various Steel, Electronic
PVC or Stainless Steel
Nylon
Stainless Steel and Steel

 **Note:** Material type can be verified with use of a magnet with stainless and aluminum being non-magnetic.

REV	ECO	DESCRIPTION	DATE	DFTM	CHKD
E	13582	UPDATED HARDWARE	11/2/2018	TH	DSH

ITEM		QTY			PART NUMBER			DESCRIPTION		
1	2	A-425-7373	3 FT.	4 FT.	5 FT.	6 FT.	Lateral Biosafety Cabinet Latch			
2	8	A-500-395					Basestand Leg Bushing			
3	2	B-500-386					Basestand End Panel Weldment			
4	4	B-500-390					Basestand Leg Extension			
5	1	B-500-391-TAB	-01	-02	-03	-04	Cross Member Panel Weldment 3"			
6	2	B-500-393					Front Mounting Bracket			
7	2	B-500-394					Rear Mounting Bracket			
8	4	X-880443					LEG LEVELER FOR 2" SQ TUBING			
9	12	X-880494-03					Acorn Nut 1/4-20 (Low Crown) SST			
10	8	X-880494-03					Acorn Nut 3/8-18 SST			
11	8	X-880495					Nutset 1/4-20			
12	2	X-880659-02					Bolt 3/8-16 X 3/4 SST			
13	20	X-880659-12					Bolt HHCS 1/4-20 X 5/8 SST			
14	10	X-880751-07					Lock Washer 3/8 Internal Tooth SST			
15	18	X-880753-07					Washer 1/4 SAE Nickel			
16	32	X-880794-02					Lock Washer 1/4 Internal Tooth SST			
17	24	X-880815-01					Lock Washer 1/4 Internal Tooth SST			
18	8	X-880929-01					Bolt 3/8-16 X 2-3/4 SST			

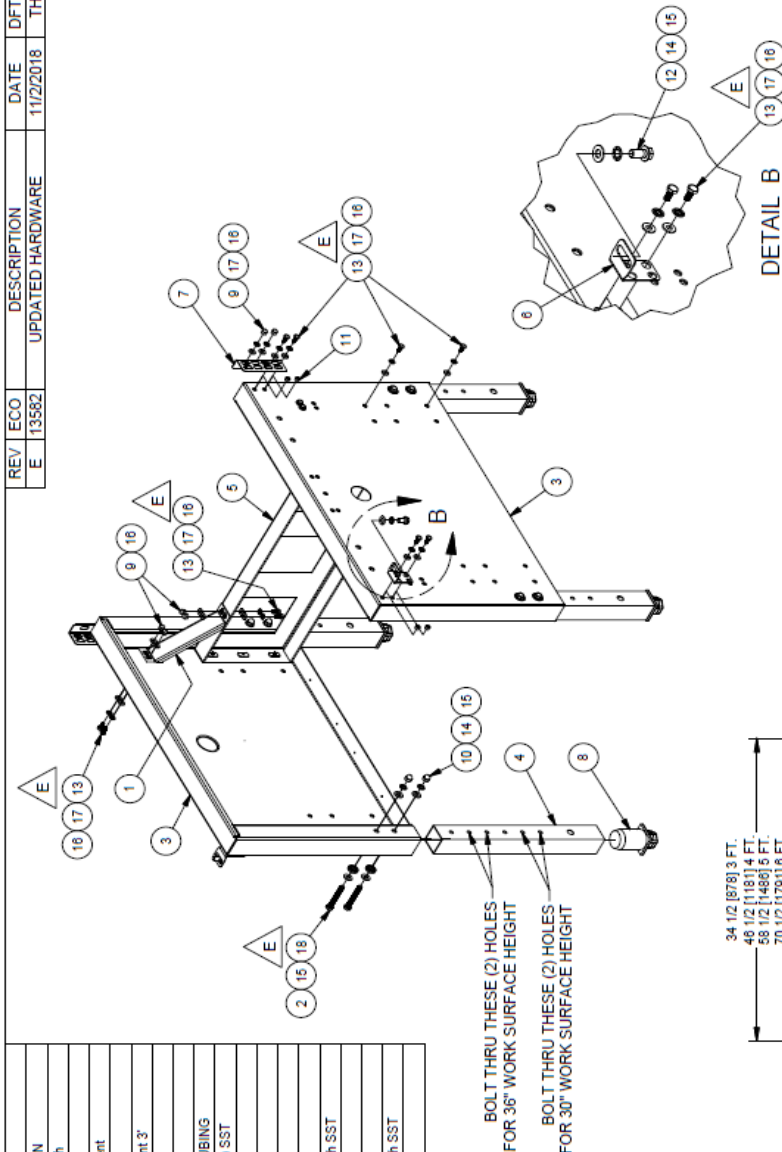

BOLT THRU THESE (2) HOLES
FOR 36" WORK SURFACE HEIGHT

BOLT THRU THESE (2) HOLES
FOR 30" WORK SURFACE HEIGHT

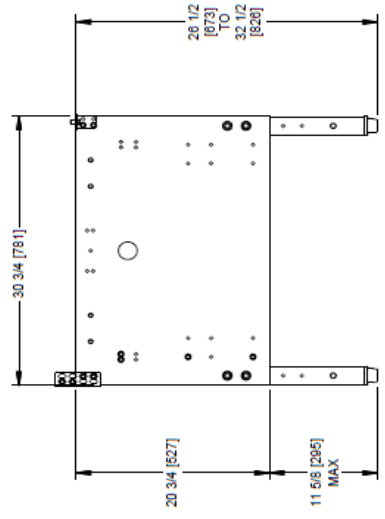
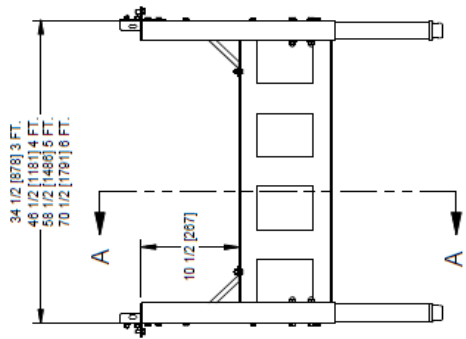
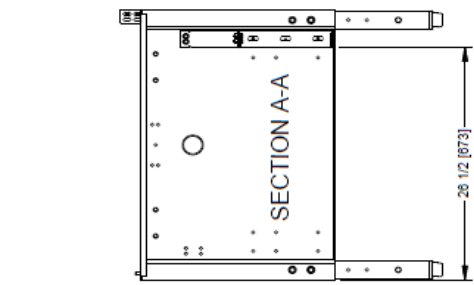

NU-475-477-480-540-543-545-560-565
NU-500-100
NU-500-101
NU-500-102
NU-500-103



TITLE		ASSEMBLY 31"	
TELESCOPING BASESTAND		W/LL	
DFTM	DATE	CRKD	SHEET
TH	11/2/2018	BP	1 OF 1
DRAWING NUMBER		BCD-16633	
		E	

REV	ECD	DESCRIPTION	DATE	DRAFT	CHKD
B	13471	ADDED NU-677	8/18/2017	TH	BP

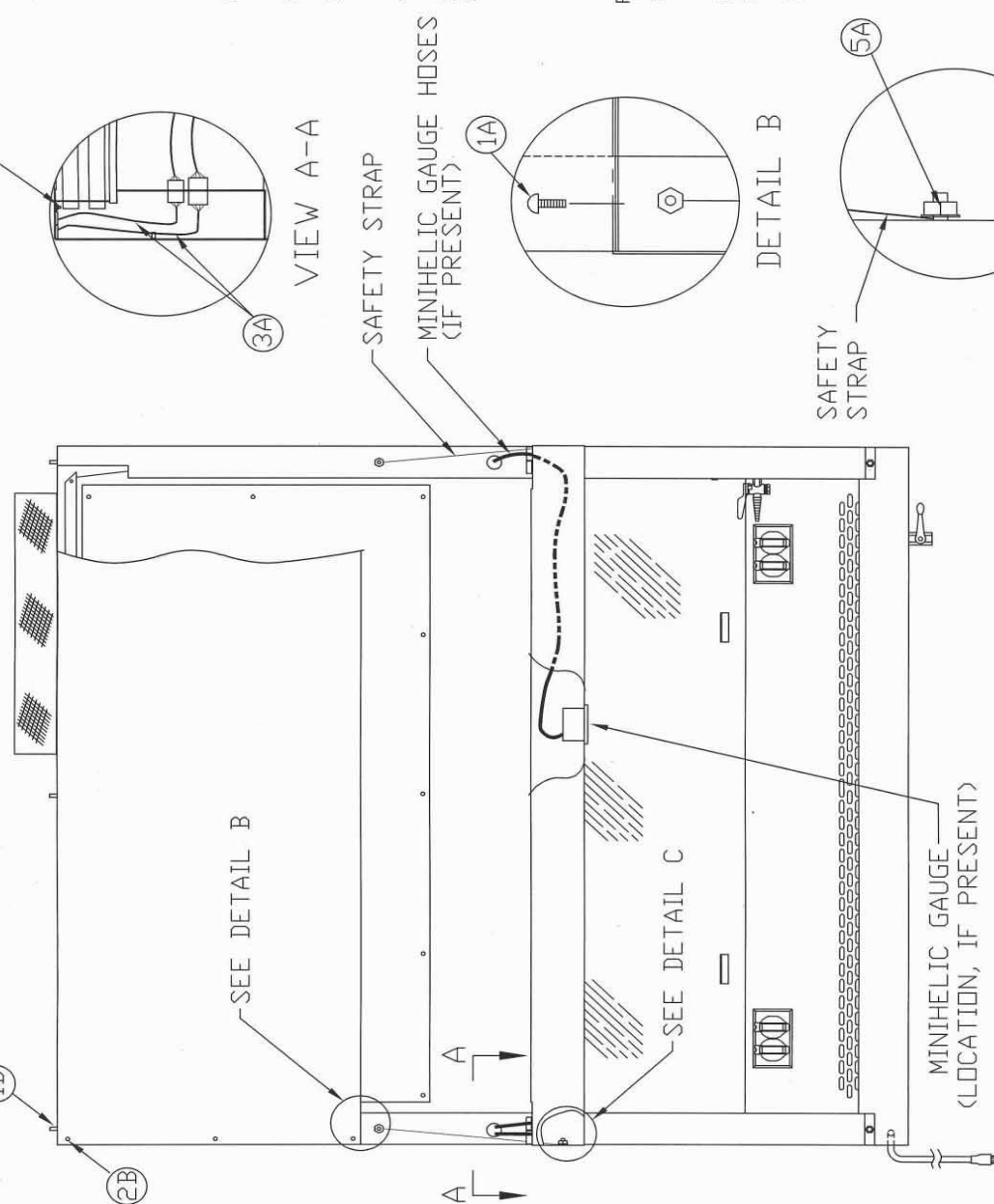

CONTROL CENTER REMOVAL PROCEDURE

CAUTION
DISCONNECT ALL ELECTRICAL SERVICE TO UNIT BEFORE STARTING PROCEDURE

- 1A.) REMOVE (2) #8-32 SCREWS FROM TOP OF CONTROL CENTER AND GENTLY LET CONTROL CENTER OPEN ON SAFETY STRAPS.
- 2A.) REMOVE MINIHELIC GAUGE HOSE (IF PRESENT) (HOSE CLAMP/MAG GAUGE).
- 3A.) DISCONNECT ELECTRICAL CONNECTORS AND CABLE CLAMPS SO THEY ARE LOOSE TO THE MAIN CABINET (BOTH SIDES).
- 4A.) REMOVE A 1/4-20 NUT FROM CONTROL CENTER HOLDING THE SAFETY STRAP (BOTH ENDS)
- 5A.) LIFT CONTROL CENTER AND PULL UP AND AWAY.
- 6A.) TO ATTACH CONTROL CENTER REVERSE THE ABOVE STEPS.

FRONT DECORATIVE PANEL REMOVAL PROCEDURE

- 1A.) REMOVE (2) #8-32 SCREWS FROM TOP OF CONTROL CENTER AND GENTLY LET CONTROL CENTER OPEN ON SAFETY STRAPS.
- 1B.) REMOVE (3) NUTS FROM TOP EDGE OF PANEL.
- 2B.) REMOVE (6) KNURLED SCREWS FROM FRONT OF PANEL, IF PRESENT.
- 3B.) TO ATTACH FRONT DECORATIVE PANEL REVERSE THE ABOVE STEPS.



VIEW A-A

SAFETY STRAP

MINIHELIC GAUGE HOSES (IF PRESENT)



DETAIL B

SAFETY STRAP

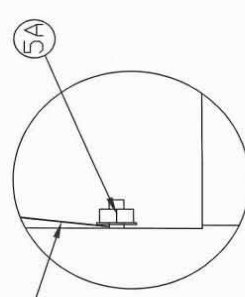

DETAIL C



ORIGINAL

NU-540 / 543 / 545 / 677
CONTROL CENTER & FRONT DECORATIVE PANEL

DFTMLS | 9/12/13 | CHKD | BP | SHEET 1 OF 1
DRAWING NUMBER BCD-16301 B

REV	ECO	DESCRIPTION	DATE	DRFT	CHKD
A	12131	RELEASED TO PRODUCTION	9/12/13	LS	BP

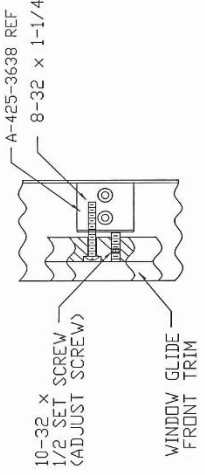

DETAIL A

WINDOW GLIDE ADJUSTMENT

THE WINDOW GLIDES HAVE ADJUSTMENTS THAT ARE LOCATED AT THE CIRCLED POSITIONS 1 THRU 4. TO ACCESS POSITIONS 1 AND 2, REMOVAL OF THE FRONT DECORATIVE PANEL IS NECESSARY. IF THE WINDOW IS TOO LOOSE AT ANY OF THE FOUR POSITIONS LOOSEN THE PHILLIPS HEAD TENSION SCREW AND TURN THE ALLEN HEAD SET SCREW CLOCKWISE A FULL TURN OR UNTIL YOU ACHIEVE THE POSITION THAT IS MOST COMFORTABLE FOR THE WINDOW TO SLIDE. THEN RETIGHTEN THE TENSION SCREW. TURN ADJUST SCREW COUNTERCLOCKWISE IF THE WINDOW IS TOO TIGHT.

3/32"

TOOLS REQUIRED:

- 1.) 3/32" ALLEN WRENCH
- 2.) PHILLIPS SCREW DRIVER

ORIGINAL



NU-545 SLIDING WINDOW ASSY & ADJUSTMENT	
DFTM/LS	9/12/13
CHKD	BP
SHEET 1 OF 1	
DRAWING NUMBER	BCD-16297
	A

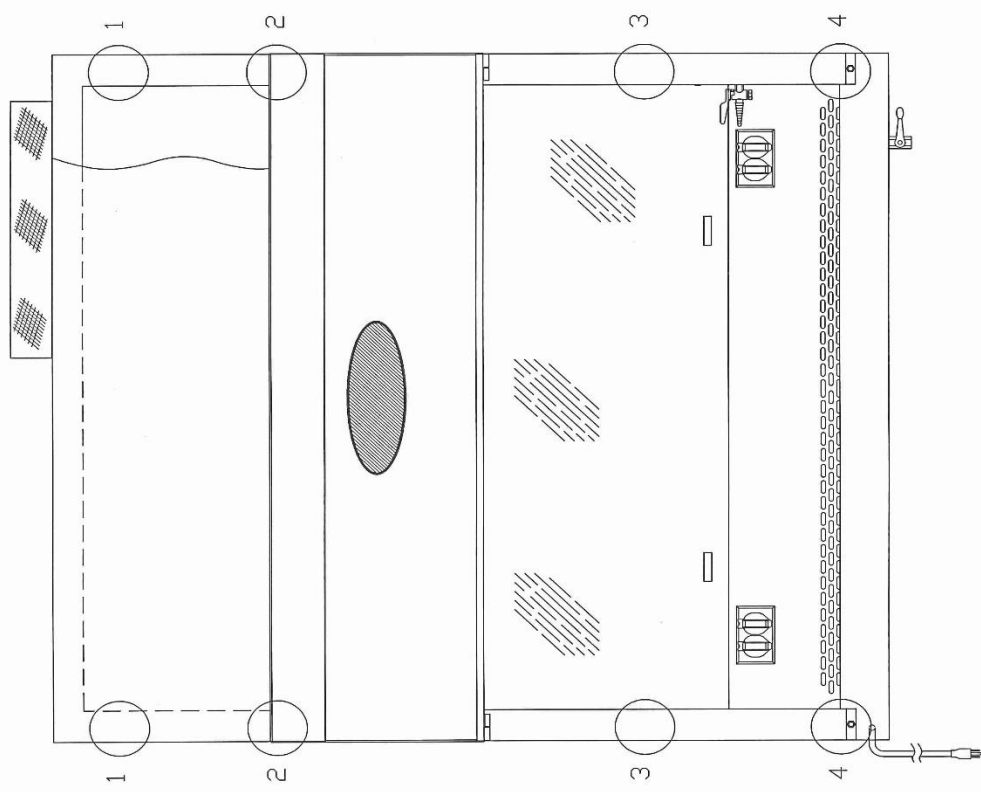

REV	ECD	DESCRIPTION	DATE	DRFT	CHKD
B	13471	ADDED NU-677	8/18/2017	TH	BP

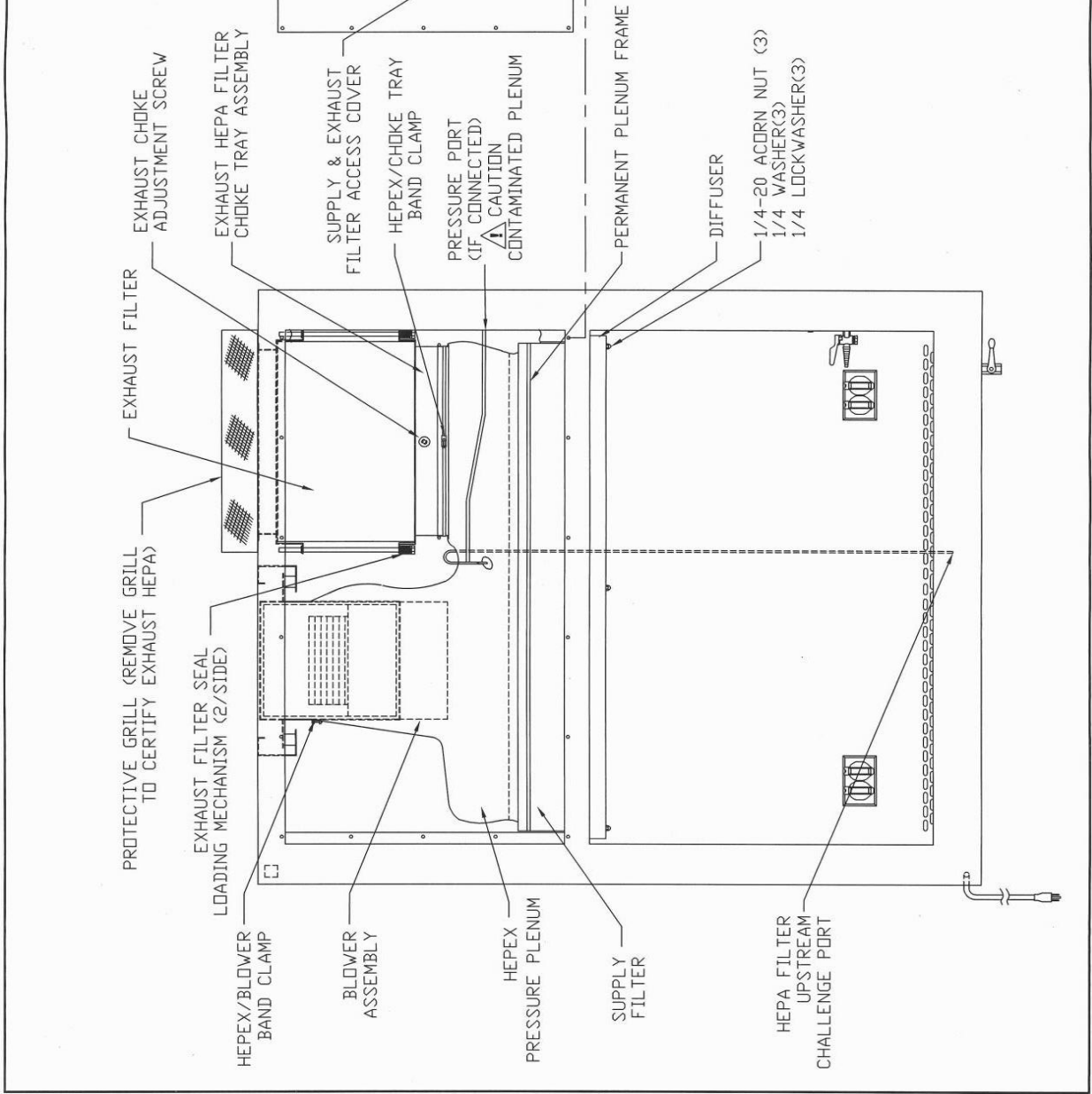

ORIGINAL	
NU-540/543/545/677 BASE CABINET ASSEMBLY	
DF1	LS
9/12/13	CHKD
BP	SHEET 1
DF1	DF1
DRAWING NUMBER BCD-16299	
B	

REV	ECO	DESCRIPTION	DATE	DRAFT	CHKD
A	12131	RELEASED TO PRODUCTION	9/12/13	LS	BP

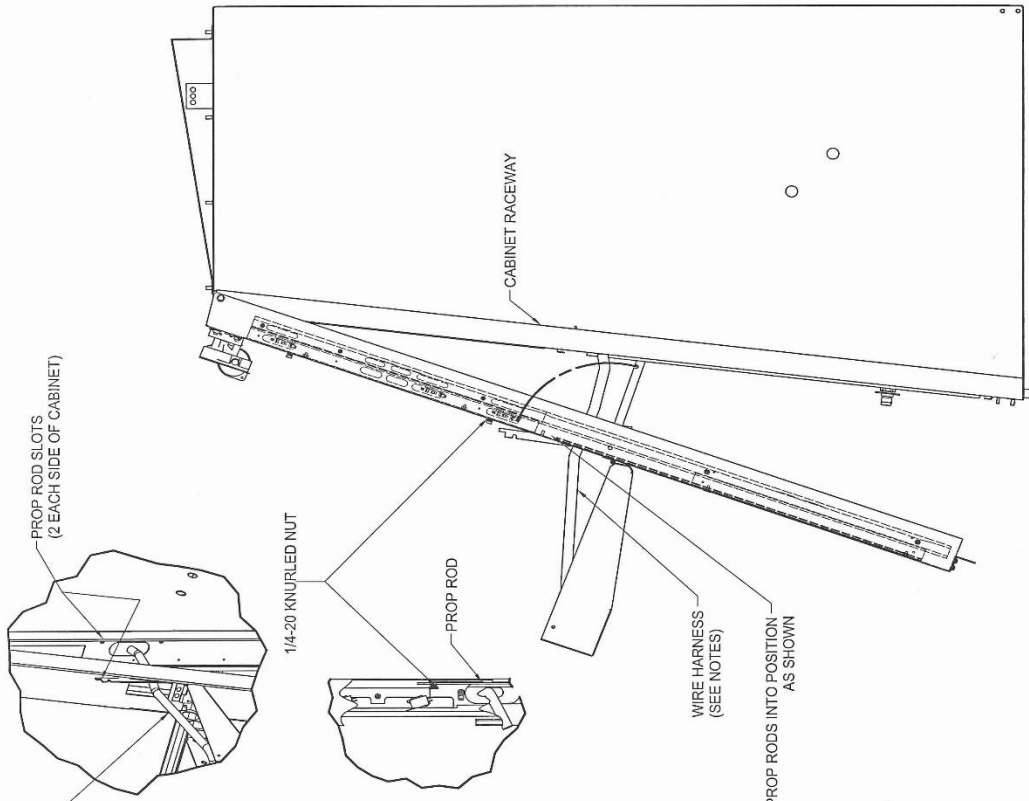

STEP 5:
PLACE PROP RODS INTO SLOTS
PROVIDED IN FRONT OF CABINET FACIA.
(2 POSITIONS AVAILABLE EACH SIDE OF CABINET)

STEP 4:
PULL OUT WINDOW ASSEMBLY FROM BOTTOM
TO ACCESS PROP ROD FROM BACK SIDE OF
WINDOW FARING.
LOOSEN 1/4-20 KNURLED NUT AS SHOWN
TO RELEASE PROP ROD FOR USE.
(1 EACH SIDE OF WINDOW)

STEP 3:
REMOVE 1/4-20 ACORN NUT
AND WASHERS FROM
EACH SIDE OF WINDOW FRAME
BOTTOM CORNERS.

1/4 INT TOOTH LOCK WASHER
1/4 FLAT WASHER

STEP 2:
REMOVE SCREWS AT EACH UPPER SIDE OF
CONTROL CENTER AND ALLOW THE CONTROL CENTER
TO ROTATE DOWN, RESTING ON SAFETY STRAPS.

STEP 1:
REMOVE ARMREST

NOTES:

1. WHEN OPENING AND CLOSING HINGED WINDOW,
CARE MUST BE TAKEN TO ASSURE WIRE HARNESS
(1 EACH SIDE) IS ROUTED CORRECTLY THRU
THE HOLE INTO AND OUT OF THE RACEWAY.

ORIGINAL



NUJ-545
WINDOW ASSEMBLY
HINGE OPERATION

DFTM	LS	9/12/13	CHKD	BP	SHEET	OF	1	
DRAWING NUMBER							BCD-16298	A

REVISION HISTORY					
REV	ECO	DESCRIPTION	DATE	DFTM	CHKD
A	9938	RELEASED TO PRODUCTION	10/19/2007	LS	DSH

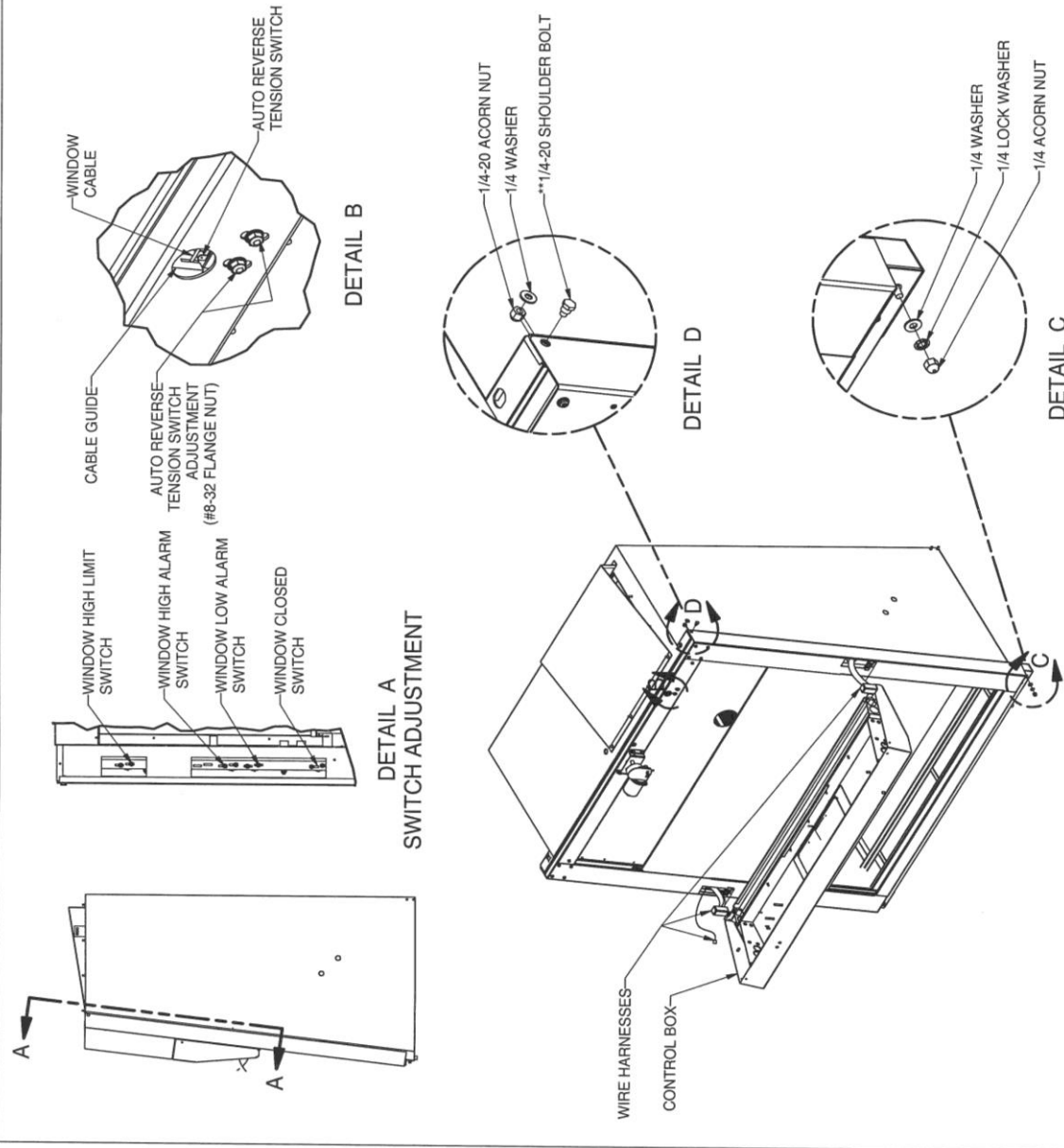

NOTES:
SWITCH ADJUSTMENT

- 1. DETAIL A**
WINDOW SWITCH ACCESS IS THRU REAR OF RIGHT SIDE RACEWAY. (LEFT FROM REAR VIEW OF CABINET).
- 2. DETAIL B**
WITH FLUSH MOUNT FRONT PANEL REMOVED THE AUTO REVERSE TENSION SWITCH IS ADJUSTED BY (2) #8 FLANGE NUTS USING VIEW CUTOUT PROVIDED FOR VISUAL TENSION ADJUSTMENT.
- WINDOW REMOVAL AND MAINTENANCE**
3. WITH FLUSH MOUNT FRONT PANEL REMOVED, DISCONNECT WIRE HARNESSES AND PROBE CABLES (2 ON LEFT, 1 ON RIGHT) DISCONNECT THE 2 PROBE CABLES AT THE PROBE BOARDS ON THE RIGHT SIDE OF CONTROL BOX).
REMOVE HINGE LOCK ON THE LEFT HINGE AND CONTROL BOX SUPPORT CABLES (1 EACH SIDE) AND REMOVE CONTROL BOX.
4. **DETAIL C**
REMOVE 1/4-20 HARDWARE EACH LOWER CORNER OF WINDOW ALLOWING FOR HINGED OPERATION OF WINDOW.
5. WITH WINDOW FRAME SUPPORTED, (RESTING ON STUDS ON BOTTOM CORNERS) REMOVE THE 1/4-20 SHOULDER BOLTS (1 EACH SIDE).
ATTENTION! GLASS POSITION SHOULD BE SET IN OPERATING POSITION DURING THE REMOVE / REPLACE PROCEDURE TO AVOID BREAKAGE!
6. CABLE ROUTE AND ATTACHMENT TO GLASS SHOWN ON BCD-12282 IS CRITICAL TO CORRECT WINDOW OPERATION. EQUAL NUMBER REVOLUTIONS ON MAIN PULLEY IS CRITICAL. IF CABLE REPLACEMENT IS REQUIRED FOLLOW THE STEPS ON BCD-12282.
7. REVERSE STEPS 3 - 5 FOR INSTALLATION.

** WHEN RE-ATTACHING THE WINDOW, DO NOT OVER TIGHTEN THE SHOULDER BOLT. (SECURE USING BLUE LOCTITE).

TITLE AUTO WINDOW SWITCH / CABLE ADJUSTMENT AND MAINTENANCE	
DFTM LS	DATE 10/19/2007
DRAWING NUMBER	CHG SHEET 1 OF 1
BCD-12281	
A	

ORIGINAL

REVISION HISTORY					
REV	ECO	DESCRIPTION	DATE	DFTM	CHKD
A	9938	RELEASED TO PRODUCTION	11/19/2007	LS	DSH

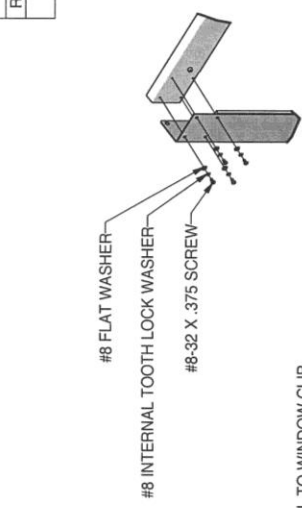
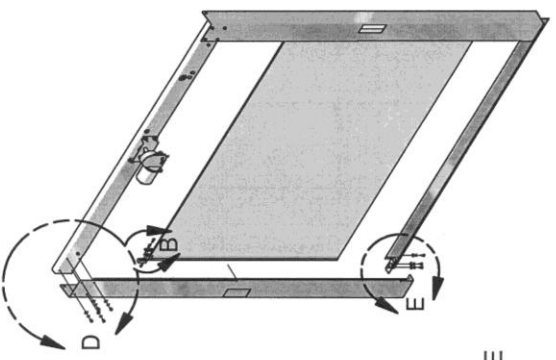

INSTALL TO WINDOW CLIP
 PRIOR TO INSTALLING WINDOW
 IN FRAME USING (BOTH SIDES)

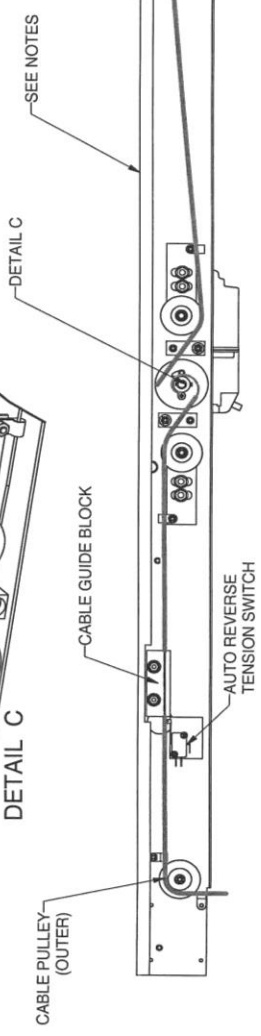
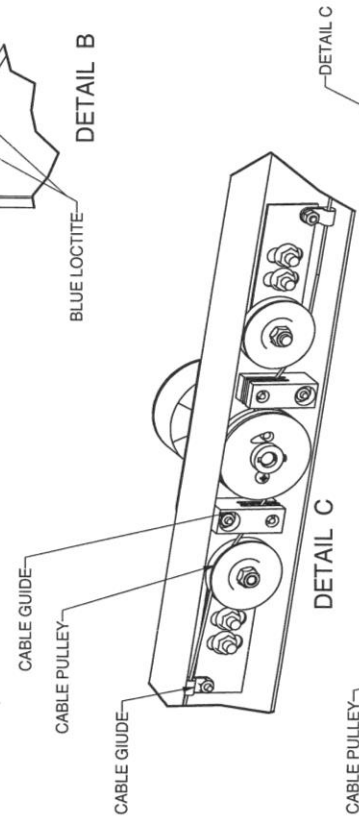
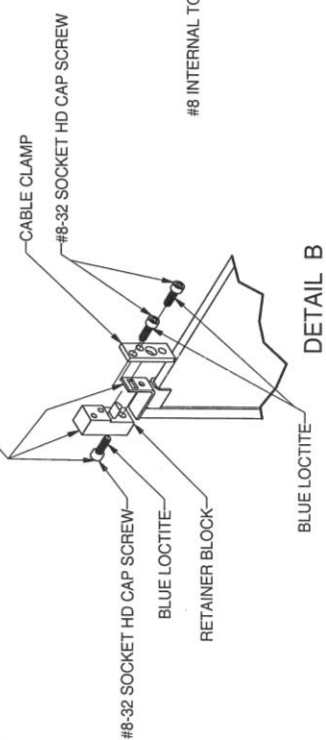
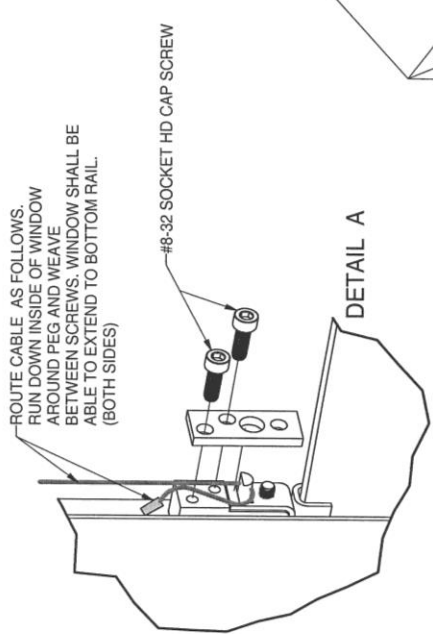
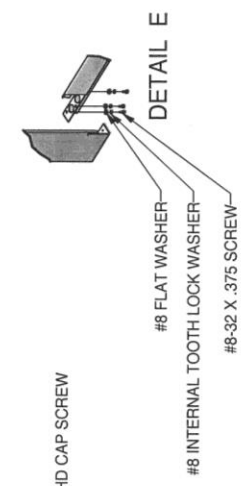

- NOTES:**
1. ADD / REMOVE HARDWARE IN DETAILS D AND E FOR GLASS REPLACEMENT. ALL OTHER STEPS ARE TO BE WITH WINDOW FRAME AND GLASS FULLY ASSEMBLED.
 2. START WITH WINDOW IN CLOSED POSITION (TO BOTTOM RAIL) TO ASSURE CORRECT CABLE LENGTHS.
 3. CABLE SHOULD BE WRAPPED CLOCKWISE 1/2 HALF REVOLUTION THEN OVER / UNDER CABLE PULLEYS. (DETAIL C)
 4. ROUTE THRU CABLE GUIDES THEN OVER OUTER PULLEYS THEN TO WINDOW AS SHOWN.
 5. SEE DETAIL A FOR CABLE ATTACHMENT TO WINDOW.
 6. THESE STEPS ARE CRITICAL TO ASSURE CORRECT WINDOW OPERATION.

ORIGINAL

TITLE AUTO WINDOW CABLE AND WINDOW ASSEMBLY						
DFTM	DATE	CHKD	SHEET	1	OF	1
LS	4/4/2007	DSH				
DRAWING NUMBER			BCD-12282			
A						

REV	CO	DESCRIPTION	DATE	DFTR	CHKD
D	000826	UPDATED BLOWER #S	6/3/2021	TH	DSH

DFTR	LS	DATE	CHKD	BP	SHEET	1	OF	2
					DRAWING		NUMBER	

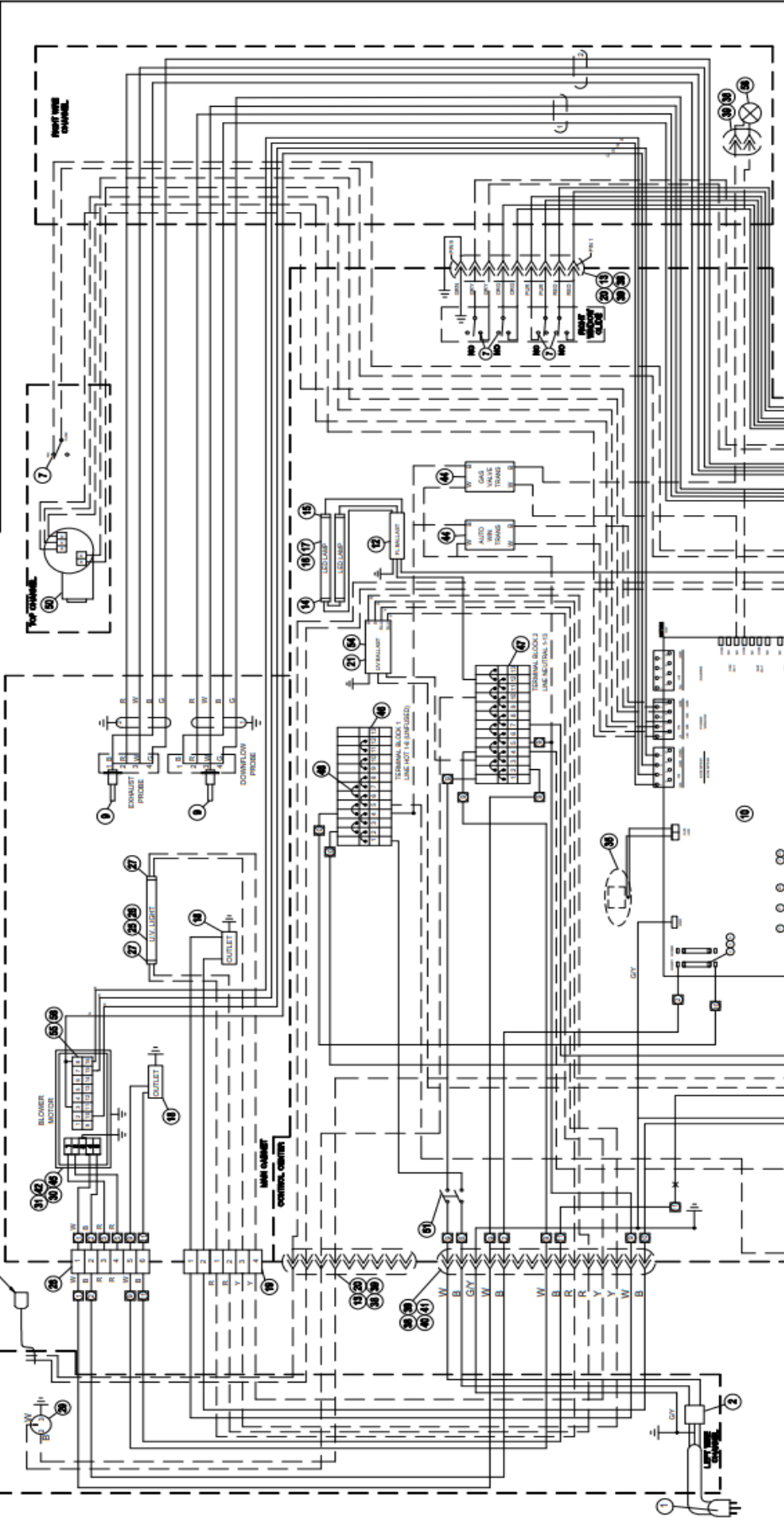



TITLE
 NU-545-300E/400E/600E/600E/230VAC, 50/60 HZ
 (ENERGY SAVER ECM MOTOR) ELECTRICAL
 SCHEMATIC

POWER SPECIFICATIONS
 230 VAC 50/60 HZ SINGLE PHASE
 3 FT., 4 FT., 5 & 6 FT.
 OUTLETS NOT TO EXCEED 3 AMPS
 □ INDICATES WIRE NUMBER
 ○ INDICATES ITEM NUMBER
 — INDICATES OPTIONAL WIRING
 * INDICATES SPARE IN WIRING (FOLLOW DASHED WIRING)

CD-000026

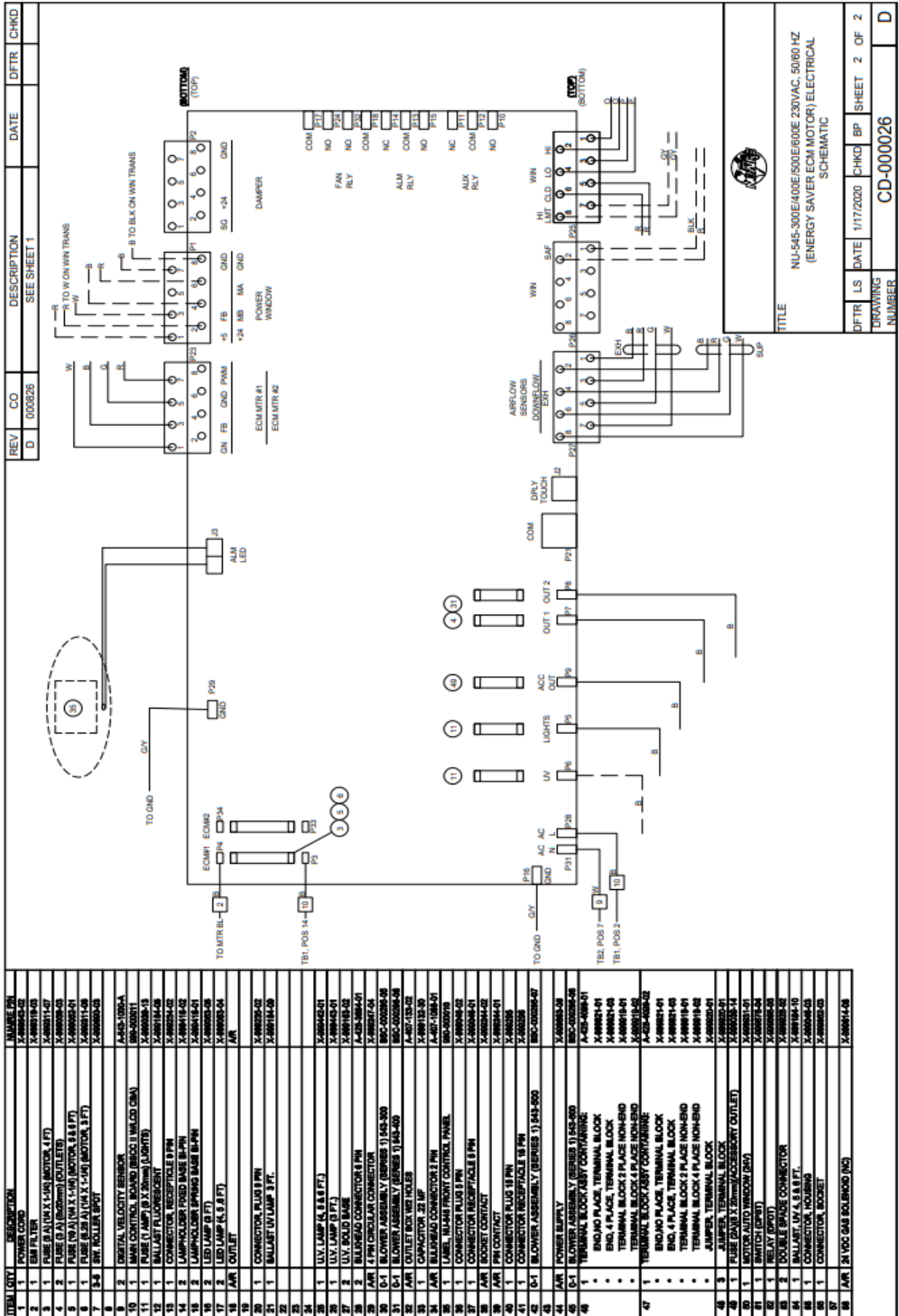

REV D 000826
DESCRIPTION SEE SHEET 1
DATE
DFTTR LS DATE 1/17/2020
CHKD BP
SHEET 2 OF 2
DRAWING NUMBER
CD-000026

TITLE
NU-545-300E/400E/500E/600E 230VAC, 50/60 HZ
(ENERGY SAVER ECM MOTOR) ELECTRICAL
SCHEMATIC